

Taylor

CUSTOM
BUILT

Tubes

1939

CATALOG and MANUAL



Taylor Tubes, Inc.

2341-43 WABANSIA AVENUE
CHICAGO, ILLINOIS

TAYLOR TUBES ARE SOLD THROUGH DISTRIBUTORS

There are TAYLOR TUBE Distributors in every logical distribution point throughout the U. S. and many foreign countries. We have attempted to see that all amateur and Broadcast Engineers could easily obtain TAYLOR TUBES when desired; and at the same time, tried to limit the distribution so that each Distributor would have a market large enough to afford carrying the complete line of TAYLOR TUBES.

All TAYLOR TUBE Distributors have been selected

with full consideration of their ability to serve and their reputation for fair dealing. We are extremely proud of the fact that Distributors not only sell TAYLOR TUBES—they RECOMMEND THEM above all others. We feel Radio Amateurs generally should recognize that the Radio Parts Distributors are their Best Friends—*anxious at all times to extend the greatest possible cooperation on every transaction.*

THERE IS A TAYLOR TUBE DISTRIBUTOR NEAR YOU.

TAYLOR TUBE RATINGS HAVE F. C. C. APPROVAL

INDEX

	Page		Page
General Information	1	866 Characteristics.....	14
T21 Characteristics.....	2	866JR "	14
T40 "	3	Curves	15, 16
TZ40 "	3	Calculating Bias	17
T20 "	4	General Tube Information.....	17
TZ20 "	4	Crystal Osc. Circuit.....	18, 19
T55 "	5	Circuit Information	18, 19, 20
T125 "	6	Transmitter Considerations	18, 19, 20
T200 "	7	Buffers and Doublers.....	19
203Z "	8	Ant. Coupling.....	20
805 "	9	L/C Ratio Data.....	20
203A "	10	Tube Installation Hints.....	20
211 "	10	275 DeLuxe Dual Unit Rig.....	21 to 29
211C "	10	Quick Band Change Rig.....	30, 31, 32
845 "	10	Taylor-National 400 watt Rig.....	33, 34, 35
814 "	11	A Complete Taylor Tube Xmtr.	36, 37, 38, 39
822 "	11	T200 Amplifier	40
204A "	12	Grid Modulation.....	41
HD203A "	12	Neutralizing Circuit	41
756 "	12	Power Supply Circuits.....	42
841SW "	12	Modulation	43
249B "	13	Tube Comparison Chart.....	44
872A "	13		

Taylor



Tubes



WARREN G. TAYLOR
President



FRANK J. HAJEK—W9ECA
Sec. & Treas.



JOSEPH F. HAJEK
Vice Pres.

1939 MANUAL AND CATALOG

New Transmitters and Circuits.

New Technical Information. New Tubes.

During 1938 Taylor Tubes maintained its leadership in the sales of Transmitting Tubes to Amateurs and added more luster to the brilliance of its famous slogan, "More Watts per Dollar", by the announcement and sales of thousands of T-40's and TZ-40's. These two types set a standard of value in the Transmitting Tube field and portend future announcements of new Taylor Types during 1939, that will advance further Taylor Tubes dominant sales and engineering leadership. Among commercial engineers and amateurs, the word is "Watch Taylor Tubes in 1939".

Taylor Tubes thanks its many friends in the commercial as well as amateur ranks for their strong support. With the introduction of this 1939 manual and catalog we again dedicate ourselves to your service. If you find the data herein of value we will feel that our efforts have been rewarded.



WM. T. BISHOP JR.
W9UI
Engineer

CHARLES KIDNER
Engineer



REX L. MUNGER—W9LIP
Sales Manager

Taylor

CUSTOM BUILT

Tubes

T-21

A TAYLOR BEAM AMPLIFIER TUBE 6 PRONG ISOLANTITE BASE

The T-21 is Taylor Tubes' answer to the demand by hundreds of Taylor Boosters for a Low Power Beam tube. As indicated by the characteristics, the T-21 is extremely easy to drive and many circuits for its operation are shown in the Taylor rigs described in this Manual. The plate dissipation rating of the T-21 is 21 watts and no color will show on the plate when operated at and within this rating. Plate dissipation in excess of this rated value should be avoided.

TYPE T-21

GENERAL CHARACTERISTICS

Heater Voltage—Volts.....	6.3
Heater Current—Amps.....	0.9
Plate Resistance—Ohms.....	22,500
Mutual Conductance—uMhos.....	6000
Amp. Factor.....	138
Max. Plate Dissipation—Watts.....	21
Max. Screen Dissipation—Watts.....	3.5

PHYSICAL CHARACTERS

Max. Length, inches.....	5 $\frac{1}{8}$
Max. Diameter, inches.....	2 $\frac{1}{16}$

INTERELECTRODE CAPACITIES

Grid to Plate, mmf.....	1.4
Input mmf.....	11.5
Output mmf.....	11.5

CLASS C AMPLIFIER

*Max. Operating Plate—volts.....	400
Max. DC Plate Current—Telegraph.....	95 M.A.
Max. DC Plate Current—Telephone.....	65 M.A.
Max. D.C. Grid Current.....	5 M.A.
D.C. Grid—volts.....	-45
Max. Driving Power—watts.....	.4
Max. Screen Current.....	16 M.A.
Max. Screen Voltage.....	300

* It is recommended that plate voltage be reduced to 300 volts at frequencies above 30 MC.

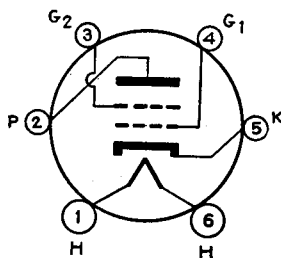

Bottom View

T-21

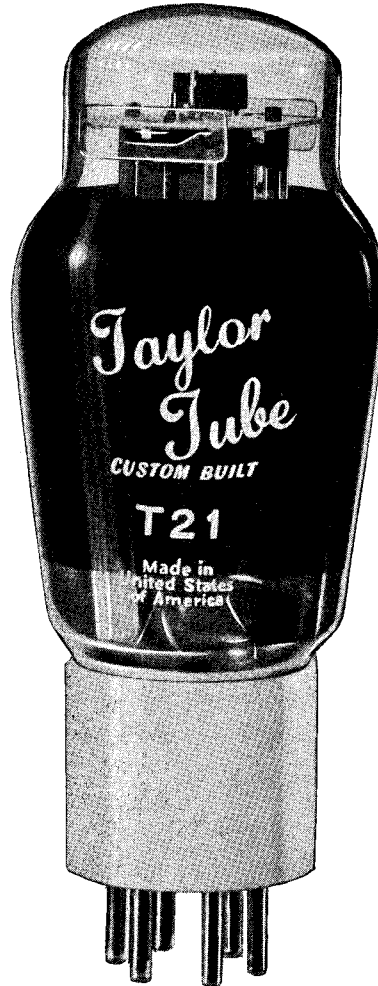

T-21

**21 WATTS
PLATE
DISSIPATION
BEAM TUBE**

\$1.95

The T-21 is a heater cathode type Beam Power Amplifier Tube especially efficient as an oscillator, amplifier or frequency multiplier and desirable for mobile and portable radio transmitters. The electrical characteristics are similar to those of the 6L6G.

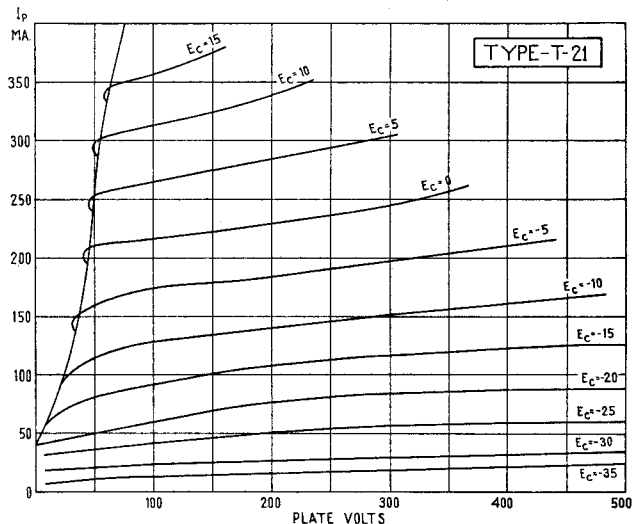

OPERATING DATA—T-40—TZ-40

T-40

**GENERAL
PURPOSE
TRIODE**

\$3.50



TZ-40

**ZERO BIAS
TRIODE**

\$3.50

40 WATTS PLATE DISSIPATION

The Wonder Tubes

In less than one year over 11,000 T-40's and TZ-40's were put into operation in Amateur Transmitters throuth the world. The T-40 has a wide range of uses on all frequencies up to 60 MC; and the TZ-40 performs most efficiently both in R.F. and Class B Audio Circuits. Offering up to 175 watts of Audio Output, the TZ-40's set a new standard of value in this field. Both types will be found to be **easy to drive**.

GENERAL CHARACTERISTICS

	T-40	TZ-40
Filament Voltage, volts.....	7.5	7.5
Filament Current, amps.....	2.5	2.5
Plate Resistance, ohms.....	8700	17,500
Mutual Conductance, uMhos.....	2800	3600
Amplification Factor.....	25	62
Max. Length, inches.....	6 1/8	
Max. Diameter, inches.....	2	
Thoriated Tungsten Filament—UX Alsimag Base		
Plate to Grid, mmf.....	4.5	

CLASS "C" AMPLIFIER

	T-40	TZ-40
Max. Operating Plate Volts		
Unmodulated DC, volts.....	1000	1000
Modulated DC, volts.....	1000	1000
Max. DC Plate Current, mils.....	115	115
Grid Volts.....	-80	-40
Max. DC Grid Current, mils.....	40	45
Driving Power—Watts.....	10	10
Max. RF Grid Current, amps.....	3	3

CLASS B AUDIO OPERATION—TZ-40

Values for 2 Tubes

DC Plate Voltage.....	1000
Bias.....	0
Peak AF Grid to Grid Voltage.....	220
Zero Signal DC Plate Current, MA.....	44
Max. Signal Plate Current, MA.....	280
Plate to Plate Load, ohms.....	6900
Average Driving Power, watts.....	3
Power Output, watts.....	175

The T40 and TZ40 are **easy to drive tubes**. They thrive on a minimum amount of excitation and their ratings are extremely conservative. While the rated plate dissipation is 40 watts no color shows on the plates until the dissipation amounts to approximately 60 watts and it takes about 90 watts to cause a red spot in the center of the plate. Any color whatever showing on the plate means that the rated plate dissipation is being exceeded. If the input is not so great that such dissipation may be expected it is a definite indication that the circuit is less efficient than it should be. To obtain best efficiency with a minimum of harmonics, we recommend that certain values of capacities be used in the plate tank and, of course, the tank coils should be proportioned accordingly to hit resonance at the operating frequencies with that amount of tuning capacity across the circuit. These capacities should be the actual amount of tank condenser in the circuit across the entire plate tank. A higher value of C will result in lower tank impedance and lower efficiency. Lower values of C will result in slightly higher efficiency, but this will be offset by increased harmonic content as well as poor linearity if the stage is modulated for phone. These values will hold for both single ended and push pull amplifiers.

1715 KC—160 MMFD	14000 KC—20 MMFD
3500 KC— 80 MMFD	28000 KC—10 MMFD
7000 KC— 40 MMFD	56000 KC— 5 MMFD

Under these conditions with an input of 1000 volts 115 MA per tube the efficiency should be approximately 75% and the output 86 watts per tube. Referring to the T40—for one tube the recommended grid bias resistor would be 3500 ohms. Half that value or 1750 ohms would be correct for two tubes, parallel or push pull. If the TZ40 is used as an RF amplifier, the information on the T40 will apply except that less bias is required. For one TZ40, the bias resistor should be 1,500 ohms. Half that value, or 750 ohms, is correct for two tubes parallel or Push Pull. The TZ40 is a more efficient doubler than the T40 and is recommended for this purpose. As a doubler, the bias resistor should be 10,000 ohms, or higher. Efficient doubler operation requires large amounts of grid drive. For CW or buffer operation, for either type of tube, the DC grid current should be 15 MA or more and for phone operation 22 MA or more per tube. Under no conditions should the DC grid current per tube exceed the max. rated value of 40 MA. Expressed in terms of power approximately 5 watts of drive are required for CW or buffer operation, or 7.5 watts for phone operation. This, of course, means that the tube may be driven to full output directly from the crystal oscillator stage. The tubes have several advantages over others in their size class. The inter-electrode capacities are lower making possible satisfactory operation on frequencies as high as 60 M. C. Bringing the plate lead out of the top of the bulb greatly reduces the possibility of voltage break-downs.

CLASS B AUDIO DATA - - - TZ-40 - - - T-40

The chart at right gives proper Class B Audio operating conditions for various outputs at different plate voltages. The most important value is the reflected load impedance which is given for the entire primary or plate to plate. The current value is the maximum average value as would be indicated on the plate current meter with sine wave input. For the same peak output with voice input the maximum average plate current will be approximately 50% to 60% of this value. The correct bias for the T-40 will limit the no-signal plate current to 22 MA per tube. The TZ-40 is a Zero Bias Tube but at 1250 volts, 4 1/2 volts of bias should be used.

Supply Voltage ↓	100	125	150	175	225	←Audio Watts Output
1250				14,000 200 MA 2.5	10,000 272 MA 3.0	←Plate to Plate Load ←Max. Av. Ip. ←Watts Drive
1000	16,000 136 MA 1.6	12000 180 MA 2.0	9000 224 MA 2.5	6900 280 MA 3.0		←Plate to Plate Load ←Max. Av. Ip. ←Watts Drive
750	6000 232 MA 2.0	←Plate to Plate Load ←Max. Av. Ip. ←Watts Drive				

T-20

GENERAL
PURPOSE
TRIODE

\$2.25



TZ-20

ZERO BIAS
TRIODE

\$2.25

20 WATTS PLATE DISSIPATION

Two triodes offering outstanding value to Amateurs. The T-20 is recommended as an extremely fine amplifier tube on all frequencies up to 60MC. The TZ-20 is designed for zero bias class B audio operation and for efficient frequency multiplying performance.

GENERAL CHARACTERISTICS

	T-20	TZ-20
Filament Voltage, volts.....	7.5	7.5
Filament Current, amps.....	1.75	1.75
Plate Resistance, ohms.....	8000	26,700
Mutual Conductance, μ Mhos.....	2500	2600
Amplification Factor.....	20	62
Max. Length, inches.....		6½
Max. Diameter, inches.....		2½

UX Ceramic Base

Plate to Grid, mmf.....	4
-------------------------	---

T-20—CLASS "C" AMPLIFIER—TZ-20

Max. Operating Plate Volts	
Unmodulated DC, volts.....	750
Modulated DC, volts.....	750
Max. DC Plate Current, mills.....	75
Max. DC Grid Current, mills.....	25
Max. Plate Dissipation, watts.....	20
Max. RF Grid Current, amps.....	2.5
RF Output, watts.....	42
Percentage of Efficiency.....	75%

TZ-20—CLASS "B" A.F. MODULATOR DATA

VALUES FOR TWO TUBES

DC Plate Voltage.....	800	600
Bias.....	0	0
Peak AF Grid to Grid Voltage.....	160V	160V
Zero Signal DC Plate Current.....	40 MA	28 MA
Max. signal Plate Current.....	136 MA	140 MA
Plate to Plate Load.....	12,000-OHMS	8,100-OHMS
Average Driving Power.....	1.8 WATTS	1.8 WATTS
Power output.....	70 WATTS	50 WATTS

OPERATING DATA—T-20—TZ-20

T-20's and TZ-20's require a minimum amount of excitation and their ratings are conservative. While the rated plate dissipation is 20 watts, no color shows on the plate until the dissipation amounts to approximately 32 watts and it takes about 45 watts to cause a cherry red spot in the center of the plate. To obtain best efficiency with a minimum of harmonics, we recommend that certain values of capacities be used in the plate tank and the tank coils should be proportioned to hit resonance at the operating frequencies with that amount of tuning capacity across the circuit. These capacities should be the actual amount of tank condenser in the circuit across the entire plate tank. A higher value of C will result in lower tank impedance and lower efficiency. Lower values of C will result in slightly higher efficiency, but this will be offset by increased harmonic content as well as poor linearity if the stage is modulated for fone. These values will hold for both single ended and push-pull amplifiers.

1715 KC—160 MMFD	14000 KC—20 MMFD
3500 KC—80 MMFD	28000 KC—10 MMFD
7000 KC—40 MMFD	56000 KC—5 MMFD

Under these conditions with an input of 750 volts 75 MA per tube the efficiency should be approximately 75% and the output 42 watts per tube. For one tube, the recommended grid bias resistor would be 6000 ohms. Half that value or 3000 ohms would be correct for two tubes, parallel or push-pull. For CW or buffer operation, the DC grid current should be 12 MA or more and for phone operation should be 17 MA or more per tube. Under no conditions should the DC grid current per tube, exceed the rated value of 25 MA. Expressed in terms of power approximately 2.5 watts of drive are required for CW or buffer operation or 5 watts for fone operation. This means that the tube may be driven to full output directly from the crystal oscillator stage.

The TZ20 is primarily designed for zero bias Class B audio operation and no bias is required for such operation at voltages up to 800. It is the ideal Class B audio tube for outputs up to 70 watts and 4 of them push pull parallel will form a most economical 140 watt modulator. For pushpull parallel operation the reflected load impedance will be half and the output twice that for two tubes. The Class B operating conditions for the T20 and TZ20 are identical but the TZ20 avoid the necessity for a source of grid bias with good voltage regulation. At 800 volts the no-signal plate current to a pair of TZ20's will be approximately 25 to 30MA.

If the TZ20 is used as an RF amplifier the information on the T20 above will apply except that somewhat less bias is necessary. For one TZ20 the bias resistor should be 4000 ohms. Half that value or 2000 ohms would be correct for two tubes push pull or parallel.

The TZ20 is a more efficient doubler than the T20 and is recommended for this purpose. As a doubler the bias resistor should be 6000 ohms or higher. Efficient doubler operation requires large amounts of grid drive.

CAUTION: These tubes have metal plates and do not have the carbon anode which is characteristic of all other TAYLOR Transmitting Tubes. This does not mean that they will be any less efficient but it does mean that they will not stand as much abuse. The plate voltage should be reduced while making adjustments to prevent excessive heating. Properly handled, the efficiency of these tubes will be as great as though they had carbon anodes and their life will be equally as long.

CLASS B AUDIO DATA . . . TZ-20 . . . T-20

The chart at right gives proper Class B Audio operating conditions for various outputs at different plate voltages. The most important value is the reflected load impedance which is given for the entire primary or plate to plate. The current value is the maximum average value as would be indicated on the plate current meter with sine wave input. For the same peak output with voice input the maximum average plate current will be approximately 50% to 60% of this value. The correct bias 35 volts will limit the T-20 no-signal plate current to between 10 and 15 MA per tube. The TZ-20 requires no bias voltage.

D.C. Plate Voltage ↓	40	50	60	70	←Audio Watts Output
800	78MA 21,000	98MA 17,000	117MA 14,000	137MA 12,000	←Max. Av. Ip. ←Plate to plate load
700	92MA 15,000	115MA 12,000	140MA 10,000		←Max. Av. Ip. ←Plate to plate load
600	113MA 10,200	140MA 8,100			←Max. Av. Ip. ←Plate to plate load

Taylor



Tubes

T-55

55 WATTS PLATE DISSIPATION

Carbon Anode

The TAYLOR T-55 is a tube of medium power capable of efficient power output at frequencies as high as 120 megacycles yet it operates at reasonable values of plate voltage and plate current. Its medium low inter-electrode capacities and efficient flat form of construction result in low losses across the elements avoiding the necessity for high voltages for good efficiency and reducing the grid drive requirements. The T-55 will give more power output for a given amount of grid drive than any other high frequency tube of the same comparative class. The unique design of this tube permits use of ceramic internal insulators. The misalignment of elements (which so often develop in tubes with self-supporting elements) is impossible in the T-55.

GENERAL CHARACTERISTICS

Filament Voltage, volts.....	7.5
Filament Current, amps.....	3.0
Plate Resistance, ohms.....	9000
Mutual Conductance, μ Mhos.....	2200
Amplification Factor (Mu).....	20
Thoriated Tungsten Filament—NONEX GLASS	

OVERALL DIMENSIONS

Maximum Length, inches.....	7
Maximum Diameter, inches.....	2 $\frac{5}{8}$

INTERELECTRODE CAPACITIES

Plate to Grid, mmf.....	3.75
Grid to Filament, mmf.....	4.0
Plate to Filament, mmf.....	1.5

CLASS "C" OSC AND POWER AMP

Max. Operating Plate Volts	Class C	OSC.
Unmodulated DC, volts.....	1500	1250
Modulated DC, volts.....	1500	1000
Max. DC Plate Current, mils.....	150	125
Max. DC Grid Current, mils.....	40	40
Max. Plate Dissipation, watts.....	55	55
Max. RF Grid Current, amps.....	5	5
RF Output, watts.....	168	66
Percentage of Efficiency.....	75%	40%

NORMAL OPERATION—Class C

$E_p = 1500$ v.	$E_g = -200$ v.	$E_f = 7.5$
$I_p = 150$ MA	$I_g = 25$ MA	

The improved T-55 may be used interchangeably with previous T-55's in all applications.

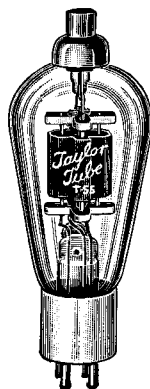

T-55

AMATEUR'S FAVORITE TUBE!
OVER 9000 IN USE

Improved
\$6.00

Now the T-55 has been further improved. No basic changes have been made but small improvements have resulted in superior characteristics, which even more than in the past, will make the T-55 stand head and shoulders above others in its price range. Throughout the world, many commercial companies, as well as amateurs, acclaim the T-55 as "the champion" of all transmitting tubes. The T-55 is the fastest selling transmitting tube of reasonable size because it is designed to permit efficient operation at the highest frequencies used by Amateurs—because the rating of 55 watts plate dissipation is conservative—and because the tube will operate at normal efficiency with a minimum of grid drive. Its low price, of course, fulfills the TAYLOR slogan, "More Watts Per Dollar."

While the rated plate dissipation is 55 watts, no color shows until the dissipation amounts to 75 watts. To obtain best efficiency with a minimum of harmonic content, we recommend that certain values of capacity be used in the plate tank and the tank coils should be proportioned to hit resonance at the operating frequency with the proper amount of capacity in the circuit. These capacities should be the actual amount of tank condenser in the circuit across the entire plate tank. A higher value of C will result in lower tank impedance and lower efficiency. A lower value of C will result in slightly higher efficiency, but this will be offset by increased harmonic content as well as poor linearity when the stage is modulated. These values will hold for both plate neutralized single ended and push pull amplifiers operated at the rating of 1500 volts 150 MA per tube. (Single ended 1500 volts 150 MA—push pull 1500 volts 300 MA.)

1715 KC—160 Mmfd	14000 KC—20 Mmfd
3500 KC—80 Mmfd	28000 KC—10 Mmfd
7000 KC—40 Mmfd	56000 KC—5 Mmfd

Under these conditions with an input of 1500 volts 150 MA per tube, the efficiency should be approximately 75% and the output approximately 170 watts per tube. For one tube the recommended grid bias resistor would be 8000 ohms. Half that value or 4000 ohms would be correct for two tubes parallel or push pull. For CW or buffer operation the rectified grid current should be 17 MA or more and for phone operation should be 25 MA or more per tube. Under no conditions should the rectified grid current exceed the rated value of 40 MA. Expressed in terms of power approximately 7.5 watts of drive are required for efficient CW or buffer operation or 15 watts for phone operation.

Taylor



Tubes

T-125

**125 WATTS PLATE DISSIPATION
WITH ACCELERATING FINS**

The T125 is the tube amateurs have demanded to fill the gap between the T55 and T200. It's a man-sized tube at low cost and it features a new TAYLOR invention (patent applied for) making possible high efficiency at low plate voltages and with low inter-electrode capacities. Rated conservatively, one tube will handle a full 400 watts input at the maximum ratings of 2000 volts, 200MA. The interelectrode capacities are low, making possible efficient operation on even the highest amateur frequencies—but the use of the accelerating fins increases the inherent efficiency of the tube, making it far more efficient than other with comparative interelectrode capacities. These fins projecting inward toward the grid and filament effectively produce the very desirable characteristics of higher C tubes without greatly increasing the capacities. Thus this tube is truly unique in that it possesses the advantages of a low C tube together with the advantages of a higher C tube—without the disadvantages of either. It is truly a remarkable tube and is a revolutionary step forward in tube design.

GENERAL CHARACTERISTICS

Filament Voltage, volts.....	10
Filament Current, amps.....	4.5
Plate Resistance, ohms.....	5700
Mutual Conductance, uMhos.....	4400
Amplification Factor (Mu).....	25
Thorated Tungsten Filament	

OVERALL DIMENSIONS

Maximum Length, inches.....	8 1/4
Maximum Diameter, inches.....	3

INTERELECTRODE CAPACITIES

Plate to Grid, mmf.....	4.5
-------------------------	-----

CLASS "C" AMPLIFIER

Max. Operating Plate Volts	
Unmodulated DC, volts.....	2000
Modulated DC, volts.....	2000
Max. DC Plate Current, mls.....	200
Max. DC Grid Current, mls.....	60
Max. RF Grid Current, amps.....	10
RF Output, watts.....	300
Percentage of Efficiency.....	75%

NORMAL OPERATION—Class C

$E_p = 2000v.$	$E_g = -200v.$	$E_f = 10$
$I_p = 200MA$	$I_g = 50MA$	

At the rated plate dissipation of 125 watts the carbon plate shows no color but the fins operate at a bright orange color. If the type of operation or input are not such as to result in excessive dissipation, color showing on the plate may be taken as a definite indication that the circuit is less efficient than it should be. To

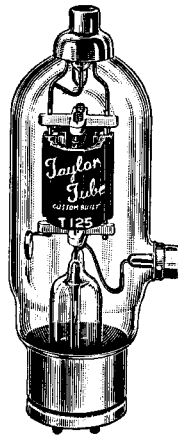

T-125

WITH ACCELERATING FINS

\$13.50

obtain best efficiency with a minimum of harmonic content, we recommend that certain values of capacity be used in the plate tank and, of course, the tank coils should be proportioned accordingly to hit resonance at the operating frequency with the proper amount of capacity in the circuit. These capacities should be the actual amount of tank condenser in the circuit across the entire plate tank. A higher value of C will result in lower tank impedance and slightly lower efficiency but the harmonic content will also be less and the linearity better if the stage is modulated. A lower value of C will result in slightly better plate efficiency but the fundamental output will not increase appreciably. The harmonic content will be higher and the linearity will be poor if the stage is modulated. These values will hold for both plate neutralized single ended and push-pull amplifiers operated at the rating of 2000 volts 200MA per tube. (Single ended 2000 volts 200MA—push-pull 2000 volts 400MA.) For operation at other values of voltage or current the optimum value will be different but may be calculated easily because it will vary inversely as frequency and applied voltage and directly as the plate current.

1900KC—137 Mmfd.	14,200KC—18 Mmfd.
3750KC— 70 Mmfd.	28,500KC— 9 Mmfd.
7150KC— 36 Mmfd.	58,000KC— 5 Mmfd.

Under these conditions with an input of 2000 volts 200 MA per tube, the efficiency should be approximately 75% and the output about 300 watts per tube. For one tube the recommended grid bias resistor would be 4000 ohms. Half that value, or 2000 ohms, would be correct for 2 tubes parallel or push-pull. For CW or buffer operation, the rectified grid current should be 30MA or more and for plate modulated phone operation should be 50MA or more per tube. Under no conditions should the rectified grid current exceed the rated value of 60MA. Expressed in terms of power approximately 10 watts of grid drive are necessary for efficient CW or buffer operation or 20 watts for phone operation. Large outputs may be obtained with lesser amounts of grid drive but the plate efficiency may be expected to be less with lesser amounts of grid excitation though the power gain will increase.

For some time there has been a need for a high frequency tube to replace tubes of the 203A type with the absolute minimum of changes in the transmitter. The T125 fills the need in a most satisfactory manner. Because of the exclusive TAYLOR Accelerating Fins construction, efficiencies on the order of those obtained with 03A's are possible at the same plate voltages and with the same low grid drive requirements. In addition the plate dissipation is greater than that of an 03A and the plate current rating greater making it possible to increase the power at the same Plate voltage as well as gaining the advantages of low C tube operation at the higher frequencies. In order to replace an 03A type of tube with the T125 it will be necessary only to change the grid and plate connections and to re-neutralize. If the minimum capacity of the neutralizing condenser is too high, plates may be removed. No circuit or bias changes are necessary because the Mu of the T125 is the same as that of an 03A.

Taylor



Tubes

T-200

The T-200 has often been called "The Amateur's Power House Tube." At the maximum plate modulated rating a single tube will handle 700 watts of input, 2000 volts at 350 MA. For CW operation the plate voltage may be increased to 2500 volts for an input of 875 watts to a single tube. A pair of these tubes push-pull will loaf along at far below the ratings with 1 kw input on any frequency from 30 to 1.7MC. This tube in common with all Taylor tubes uses the most efficient flat form of construction and the inter-electrode capacities represent the best possible combination of inter-electrode capacities and other characteristics for best efficiency at moderate plate voltages with minimum grid drive requirements. The inter-electrode capacities are low enough for ease of neutralization even at the highest amateur frequencies yet are not so low that the characteristics of the tube are adversely affected.

For best efficiency with minimum harmonic content, certain L/C ratios which are a function of the type of operation, frequency, plate voltage and plate current are recommended. These optimum ratios may be found for any amateur band and any reasonable values of input in the L/C ratio charts in both the ARRL and West Coast handbooks.

Under proper operating conditions with an input of 2000 volts 350MA the efficiency should be approximately 75% and the output approximately 525 watts per tube. For one tube the recommended grid bias resistor would be 5000 ohms. Half that value or 2500 ohms would be correct for 2 tubes parallel or push-pull. For CW or buffer operation the rectified grid current should be 35MA or more and for phone operation should be 60MA or more per tube. Under no conditions should the rectified grid current exceed the maximum rated value of 80MA per tube. Expressed in terms of power, approximately 20 Watts of grid drive are required for efficient CW or buffer operation or 35 watts for phone operation. Large outputs may be obtained with lesser amounts of grid drive but the plate efficiency may be expected to be less with reduced excitation though the power gain will increase.

The T200 is widely used in Diathermy equipment. This type of service is particularly hard on Tubes and the general acceptance of the T200 by many leading manufacturers of Diathermy equipment is convincing proof of the T200's rugged construction and conservative rating. Do not confuse the T200 with smaller tubes bearing the same type number. Compare the size of its Super Carbon Anode with tubes of similar ratings.

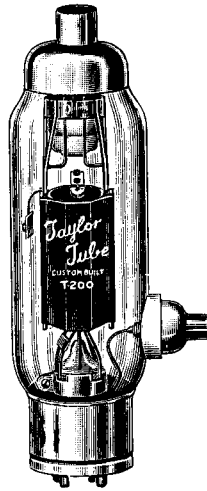

T-200

200 WATTS PLATE DISSIPATION

\$21.50

AMATEUR'S POWER HOUSE TUBE

SUPER CARBON ANODE

LENGTH 2½ in.

WIDTH 1⅝ in.

GENERAL CHARACTERISTICS

Type T-200

Filament Voltage	10.0
Filament Current, amps.....	5.75
Plate Resistance, ohms.....	3400
Mutual Conductance, uMhos.....	4800
Amplification Factor	16.6
Thoriated Tungsten Filament—NONEX GLASS	

OVERALL DIMENSIONS

Maximum Length, inches	9½
Maximum Width, Including Grid Cap, inches.....	3¾

INTERELECTRODE CAPACITIES

Plate to Grid, mmf.....	7
Grid to Filament, mmf.....	5
Plate to Filament, mmf.....	3

CLASS "C" OSC. AND POWER AMP.

Max. Operating Plate Volts	
Unmodulated D.C., volts.....	2500
Modulated, volts	2000
Max. D.C. Plate Current, mls.....	350
Max. D.C. Grid Current, mls.....	80
Max. Plate Dissipation, watts.....	200
Max. R.F. Grid Current, amps.....	15
R.F. Output, watts.....	500
Grid Volts	—300

NORMAL OPERATION

$E_p = 2500$	$E_g = -300$	$E_f = 10$
--------------	--------------	------------

T-200 POPULARITY

SOME OF THE BEST HAM PHONE STATIONS USE TAYLOR T200'S. W9EDW, W9UAQ, W9KYM, W9VXZ, W9JDO, W8JOE, W8BWH, W9IPS, W9ORA, W7CEO, W9NLP, W8CKC, W3EOZ, W3DQ, W9PZ, W8UD, W9LIP, W9ECA AND MANY OTHERS ARE T-200 USERS.

Taylor



Tubes

203-Z

ZERO BIAS TUBE

The 203Z is an improved high mu zero bias version of the 203A and 203B. It has all the desirable characteristics of these tubes with two additional features of great merit; the amplification factor of the tube is high enough for zero bias class B operation at voltages up to 1000 and the plate lead is brought out the top greatly minimizing the chances of voltage breakdowns.

The 203Z is specifically designed for class B audio. Its characteristics and its low price will make it the most popular tube for this purpose. In practical application of class B audio the average plate dissipation is low compared with the peak output and advantage of this fact has been taken to produce a tube of large capabilities at a low price. The conservative plate dissipation ratings of the tube is 65 watts. As this dissipation the tube shows no color whatever and under normal operating conditions the average plate dissipation will be less than this value under the maximum rated conditions so no color should show on the plate. If the tubes do show color it is an indication that the circuit is less efficient than it should be unless the input or type of operation are such as to result in excessive plate dissipation.

The no-signal or static plate current is about 35MA per tube at 1000 volts and about 45MA per tube at 1250 volts. Because the 203Z is a zero bias tube the grid starts to draw current as soon as excitation is applied the input transformer design requirements are less involved and excellent frequency response with minimum distortion is easily realized. The maximum average grid driving power is approximately 7 watts. Low impedance triodes such as 2A3's or 6A3's should be used in the driver stage.

The 203Z is also suited for RF operation on frequencies below 15MC. At the maximum ratings of 1250 volts 175MA the input would be 219 watts, the output approximately 165 watts per tube, and the plate dissipation 55 watts per tube. For one tube the recommended bias resistor would be 2500 ohms. Half that value or 1250 ohms, would be correct for 2 tubes parallel or push-pull. For CW or buffer operation the rectified grid current should be 30MA or more and for phone operation should be 50MA or more. Under no conditions should the rectified grid current exceed the maximum rated value of 60MA. Expressed in terms of power, approximately 8 watts of grid drive are required for efficient CW or buffer operation or 15 watts for phone operation.

Regular Class B input and output transformers as manufactured for type 203A tubes by Thordarson, Utah, Jefferson, General, Stancor, United, Kenyon, Inca, etc., may be used with the 203Z tubes.

203Z CLASS B AUDIO DATA

Supply Voltage	150	200	260	300	←Audio Watts Output
1250	.175 15,800	.233 11,800	.306 9,000	.350 7,900	←Max. Av. Ip ←Load Impedance plate to plate
1100	.204 11,600	.272 8,750	.352 6,700		←Max. Av. Ip ←Load Impedance plate to plate
1000	.228 9,300	.306 6,900			←Max. Av. Ip ←Load Impedance plate to plate
900	.259 7,200	.345 5,400			←Max. Av. Ip ←Load Impedance plate to plate

The chart above gives proper Class B Audio operating conditions for various outputs at different plate voltages. The most important value is the reflected load impedance which is given for the entire primary or plate to plate. The current value is the maximum average value as would be indicated on the plate current meter with sine wave input. For the same peak output with voice input the maximum average plate current will be approximately 50% to 60% of this value.

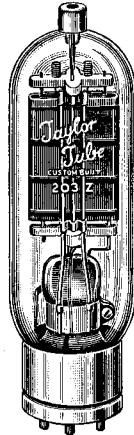

203-Z

65 WATTS PLATE DISSIPATION

METAL PLATE

\$8.00

ZERO BIAS

GENERAL CHARACTERISTICS

Type 203Z

Filament Voltage, volts.....	10
Filament Current, amps.....	3.25
Plate Resistance, ohms.....	16,700
Mutual Conductance, uMhos.....	5,900
Amplification Factor.....	85
Thoriated Tungsten Filament—NONEX GLASS	

GENERAL DIMENSIONS

Maximum Length, inches.....	8 1/4
Maximum Diameter, inches.....	2 1/8

CLASS B AUDIO OPERATION

Values for 2 Tubes

DC Plate Voltage.....	1250
Bias Volts—at 1000 Volts—0.....	4 1/2
Peak AF Grid to Grid Voltage.....	220
Zero Signal DC Plate Current, MA.....	90
Max. Signal Plate Current, MA.....	350
Plate to Plate Load, ohms.....	7900
Average Driving Power, watts.....	8
Power Output, watts.....	300

CAUTION: These tubes have metal plates and do not have the carbon anode which is characteristic of other TAYLOR Transmitting Tubes. This does not mean that they will be any less efficient but it does mean that they will not stand as much abuse. The plate voltage should be reduced while making adjustments to prevent excessive heating. Properly handled, the efficiency of these tubes will be as great as though they had carbon anodes and their life will be equally as long.

IMPORTANT

When operating 203Z's or any other tubes in parallel, it is recommended that precautions be taken to eliminate parasitic oscillation. For Class B audio, resistances of 50 to 100 ohms should be used in each plate lead. For RF amplifiers where tubes are used in parallel, the suppressing resistor should be used in the grid circuit and should be of 10 to 50 ohms and preferably non-inductive such as IRC No. NAB.

Taylor

**CUSTOM
BUILT**

Tubes

805

**125 WATTS PLATE DISSIPATION
CARBON ANODE**

\$13.50

**ZERO BIAS
UP TO 450 WATTS
CLASS B AUDIO OUTPUT**

**GENERAL CHARACTERISTICS
Type 805**

Filament Voltage, volts..... 10
 Filament Current, amps..... 3.25
 Amplification Factor—Variable..... 40 to 60
 Thoriated Tungsten Filament—NONEX GLASS

OVERALL DIMENSIONS

Maximum Length, inches..... 8½
 Maximum Diameter, inches..... 2⅞

INTERELECTRODE CAPACITIES

Plate to Grid, mmf..... 6.5
 Grid to Filament, mmf..... 8.5
 Plate to Filament, mmf..... 10.5

CLASS "C" POWER AMP.

Max. Operating Plate Volts
 Unmodulated D.C., volts..... 2,000
 Modulated D.C., volts..... 1,750
 Max. D.C. Plate Current, mls..... 200
 Max. D. C. Current, mls..... 60
 Max. Plate Dissipation, watts..... 125
 Max. R.F. Grid Current, amps..... 8

CLASS B AUDIO OPERATION

DC Plate Voltage..... 1,750
 Bias—22½
 Peak AF Grid to Grid Voltage..... 350
 Zero Signal DC Plate Current, MA..... 60
 Max. Signal Plate Current, MA..... 390
 Plate to Plate Load, ohms..... 10,000
 Average Driving Power, watts..... 8.4
 Power Output, watts..... 450

ZERO BIAS TUBES

Zero Bias Tubes have a high amplification factor so that the static plate current at the rated plate voltage is at a value well below the rated plate dissipation of the tube with the grid return connected directly to the filament center tap.

The Zero Bias type of tube approaches the ideal for Class B audio amplifier use. Since the grid has no negative potential supplied from batteries or power pack, current will flow from grid to filament over the entire positive portion of the input cycle. The impedance of the grid filament circuit is constant enough to reflect a fairly uniform load resistance to the plate circuit of the driver stage, which is important in securing good quality.

Zero Bias tubes are very efficient and very easy to control when operated at their rated plate voltages. Raising the plate voltage slightly and applying a small amount of negative bias does not disturb the wave form to any great extent; however, excessive plate voltage with a corresponding increase of bias will distort the wave form to undesirable proportions.

In examining the characteristics of a good driver tube for a Class B audio amplifier, we find, for example, the 2A3 has an amplification factor of 4.2 when operating into the primary of a transformer whose secondary is unloaded, or working into grids that are negative and hence not drawing current. AC voltage applied to the grids in excess of the negative bias voltage causes current to flow reflecting load to the driver stage. The 2A3's operating at optimum load impedance have a voltage gain of 2.7. It is

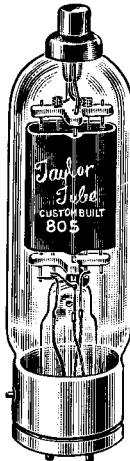

805

ZERO BIAS TUBE

The 805 is a high mu zero bias tube of popular type incorporating the use of the famous heat tested Speer processed carbon anodes together with the Taylor Floating anode type of construction. The plate lead is brought out the top greatly minimizing the chances of voltage breakdowns.

The 805 is a general purpose triode that is especially efficient for Class B audio and Class C amplifiers. The conservative plate dissipation rating of the tube is 125 watts. At this dissipation, the anode shows no color whatever and under normal operating conditions the average plate dissipation will be less than this value under the maximum rated conditions so no color should show on the plate. If the tubes do show color, it is an indication that the circuit is less efficient than it should be unless the input or type of operation are such as to result in excessive plate dissipation.

The no-signal or static plate current is about 55MA per tube at 1250 volts (zero bias) and about 30MA per tube at 1500 volts when 16 bias volts are added. Because the 805 is a zero bias tube, the grid starts to draw current as soon as excitation is applied. The input transformer design requirements are less involved and excellent frequency response with minimum distortion is easily realized. The maximum average grid driving power is approximately 8 watts. Low impedance triodes such as 2A3's or 6A3's should be used in the driver stage.

The 805 is well suited for RF operation on frequencies up to and including 30 MC. At the maximum ratings of 1750 volts 200MA, the input would be 350 watts, the output approximately 260 watts per tube, and the plate dissipation 90 watts per tube. For one tube the recommended bias resistor would be 2000 ohms. Half that value or 1000 ohms would be correct for two tubes parallel or PP. For CW or buffer operation the rectified grid current should be 40MA or more and for phone operation should be 50MA or more. Under no conditions should the rectified grid current exceed a value of 70MA. Expressed in terms of power approximately 10 watts of grid drive are required for CW or buffer operation or 15 watts for phone operation.

Regular Class B input and output Transformers are manufactured for the 805 tubes by such leading transformer Manufacturers as Thordarson, Utah, Jefferson, General, Stancor, United, Kenyon, Inca, etc.

805 CLASS B AUDIO DATA

Supply Voltage ↓	275	325	400	450	←Audio Watts Output
1750		270MA 15,000 4.5	330MA 12,000 6.0	390MA 10,000 8.0	←Max. Av. Ip ←Plate to Plate Load ←Watts Drive
1500	276MA 12,000 5.0	330MA 10,000 7.0	420MA 8,000 8.0		←Max. Av. Ip ←Plate to Plate Load ←Watts Drive
1250	335MA 8,000 6.25	395MA 6,800 7.0			←Max. Av. Ip ←Plate to Plate Load ←Watts Drive

The chart above gives proper Class B Audio operating conditions for various outputs at different plate voltages. The most important value is the reflected load impedance which is given for the entire primary or plate to plate. The current value is the maximum average value as would be indicated on the plate current meter with sine wave input. For the same peak output with voice input the maximum average plate current will be approximately 50% to 60% of this value.

obvious that shifting the voltage gain of the driver tube from 4.2 to 2.7 during the input cycle results in distortion. To minimize this shifting of the voltage gain, Zero Bias tubes should be operated at the Manufacturers' ratings.

Taylor



Tubes

203-A

100 WATTS PLATE DISSIPATION

CARBON ANODE

\$10.00

GENERAL CHARACTERISTICS
TYPE 203-A

Filament Voltage, volts.....	10
Filament Current, amps.....	3.25
Plate Resistance, ohms.....	6000
Mutual Conductance, uMhos.....	4200
Amplification Factor.....	25
Thoriated Tungsten Filament—NONEX GLASS	

OVERALL DIMENSIONS

Maximum Length, inches.....	7½
Maximum Diameter, inches.....	2½

INTERELECTRODE CAPACITIES

Plate to Grid, mmf.....	14
Grid to Filament, mmf.....	8
Plate to Filament, mmf.....	7

CLASS "C" OSC. AND POWER AMP.

Max. Operating Plate Volts	
Unmodulated D.C., volts.....	1500
Modulated D.C., volts.....	1250
Max. D.C. Plate Current, amps.....	.175
Max. D.C. Grid Current, amps.....	.060
Max. Plate Dissipation, watts.....	100
Max. R.F. Grid Current, amps.....	7.5
Max. R.F. Output, watts.....	160

211-C

100 WATTS PLATE DISSIPATION

CARBON ANODE

LOW INTERELECTRODE CAPACITIES

\$12.50

GENERAL CHARACTERISTICS
Type 211-C

Filament Voltage, volts.....	10
Filament Current, amps.....	3.25
Plate Resistance, ohms.....	2800
Mutual Conductance, uMhos.....	4500
Amplification Factor.....	12.5
Thoriated Tungsten Filament—NONEX GLASS	

OVERALL DIMENSIONS

Maximum Length, inches.....	7½
Maximum Diameter, inches.....	2½

INTERELECTRODE CAPACITIES

Plate to Grid, mmf.....	9
Grid to Filament, mmf.....	6
Plate to Filament, mmf.....	6.5

CLASS "C" OSC. AND POWER AMP.

Max. Operating Plate Volts	
Unmodulated D.C., volts.....	1500
Modulated D.C., volts.....	1000 1250
Max. D.C. Plate Current, amps.....	.175 .175
Max. D.C. Grid Current, amps.....	.060 .060
Max. Plate Dissipation, watts.....	100 100
Max. R.F. Grid Current, amps.....	7.5 7.5
Max. R.F. Output, watts.....	100 130

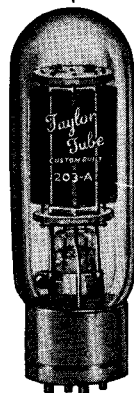

211-211-D

These two types are identical

100 WATTS PLATE DISSIPATION
CARBON ANODE

\$10.00

GENERAL CHARACTERISTICS
TYPE 211

Filament Voltage, volts.....	10
Filament Current, amps.....	3.25
Plate Resistance, ohms.....	3400
Mutual Conductance, uMhos.....	3530
Amplification Factor.....	12
Thoriated Tungsten Filament—NONEX GLASS	

OVERALL DIMENSIONS

Maximum Length, inches.....	7½
Maximum Diameter, inches.....	2½

INTERELECTRODE CAPACITIES

Plate to Grid, mmf.....	14
Grid to Filament, mmf.....	7
Plate to Filament, mmf.....	6

CLASS "C" OSC. AND POWER AMP.

Max. Operating Plate Volts	
Unmodulated D.C., volts.....	1500
Modulated D.C., volts.....	1250
Max. D.C. Plate Current, amps.....	.175
Max. DC Grid Current, amps.....	.050
Max. Plate Dissipation, watts.....	100
Max. R.F. Grid Current, amps.....	7
Max. R.F. Output, watts.....	160

845

75 WATTS PLATE DISSIPATION

CARBON ANODE

\$10.00

CLASS "A" AUDIO TUBE

GENERAL CHARACTERISTICS
TYPE 845

Filament Voltage.....	10
Filament Current, amps.....	3.25
Plate Resistance, ohms.....	2100
Mutual Conductance, uMhos.....	3000
Amplification Factor.....	5
Thoriated Tungsten Filament—NONEX GLASS	

OVERALL DIMENSIONS

Maximum Length.....	7½
Maximum Diameter.....	2½

INTERELECTRODE CAPACITIES

Plate to Grid, mmf.....	14
Grid to Filament, mmf.....	6.5
Plate to Filament.....	6

CLASS "A" AF AMP. AND MODULATOR

Max. Operating Plate Volts, volts.....	1000	1250
Max. DC Plate Current, mls.....	75	65
Peak Grid Swing, volts.....	150	205
Max. Plate Dissipation, watts.....	75	75
Max. Audio Output, watts.....	21	24
*CLASS AB Audio Output watts.....	75	105

Taylor



Tubes

822-814

200 WATTS PLATE DISSIPATION
CARBON ANODE

\$18.50

700 WATTS
AUDIO OUTPUT

in

PUSH-PULL CLASS "B" AUDIO

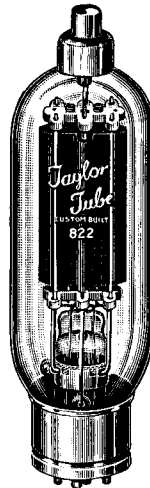

GENERAL CHARACTERISTICS

	Type 822	Type 814
Filament Voltage, volts.....	10.0	10.0
Filament Current, amps.....	4.0	4.0
Plate Resistance, ohms.....	5200	2400
Mutual Conductance, μ Mhos.....	5400	5000
Amplification Factor.....	27	12
Thoriated Tungsten Filament—NONEX GLASS		
Maximum Length, inches.....		9½
Maximum Diameter, inches.....		2½

INTERELECTRODE CAPACITIES

Plate to Grid, mmf.....	14
Grid to Filament, mmf.....	8
Plate to Filament, mmf.....	6

CLASS "C" AMPLIFIER

	Type 822	Type 814
Max. Operating Plate Volts	2500	2500
Unmodulated D.C., volts.....	2000	2000
Modulated D.C., volts.....	300	300
Max. D.C. Plate Current, mls.....	60	60
Max. D.C. Grid Current, mls.....	7.5	7.5
Max. R.F. Grid Current, amps.....	—220	—400
Grid Volts.....		

822's CLASS "B" AS MODULATOR Push Pull Operation

D.C. Plate Voltage, volts.....	2000
Grid Voltage, appr. volts.....	—67
Load Resistance (plt. to plt.), ohms—	10,000
Av. D.C. Plate Current (2 tubes), mls.....	400
Static Plate Current (per tube), mls.....	25
Power Output, (2 tubes), watts.....	500

822 CLASS B AUDIO DATA

Supply Voltage ↓	300	400	500	700	←Audio Watts Output
2,000	.240 17,000	.320 12,500	.400 10,000	.545 8,000	←Max. Av. Ip ←Load Impedance plate to plate
1,750	.275 13,000	.365 10,000	.455 7,800		←Max. Av. Ip ←Load Impedance plate to plate
1,500	.315 9,600	.405 7,600			←Max. Av. Ip ←Load Impedance plate to plate

The chart above gives proper Class B Audio operating conditions for various outputs at different plate voltages. The most important value is the reflected load impedance which is given for the entire primary or plate to plate. The current value is the maximum average value as would be indicated on the plate current meter with sine wave input. For the same peak output with voice input the maximum average plate current will be approximately 50% to 60% of this value. The correct bias will limit the no signal plate current to 25MA per tube.

822

The 822 is an unusually efficient tube. Its high efficiency is combined with extreme ruggedness and an ability to stand up under tremendous abuse. Its large carbon plate is rated at 200 watts dissipation. We recommend it highly for class B audio use in large amateur and broadcast transmitters and for RF work on all but the highest amateur frequencies. This tube is the most popular in our line for both RF and audio use in broadcast transmitters. It's a large tube at a small tube price and it is almost immune from voltage breakdowns because the plate lead is brought out the top.

For RF operation the 822 is at its best on frequencies below 8MC. On higher frequencies the interelectrode capacities are great enough to place the tube at some disadvantage compared with the T200 although the overall efficiency of a stage using 822's would be about the same as one using T200's at 14MC. The 822 will operate satisfactorily at frequencies as high as 30MC but at this frequency the T200 will prove superior and is recommended.

All ratings on the 822 are exceedingly conservative. The maximum rated plate current is 300MA and maximum modulated plate voltage 2000 allowing an input of 600 watts per tube. For unmodulated operation the maximum plate voltage rating is 2500 volts permitting input of 750 watts.

Under the above conditions the recommended grid bias resistor would be 4000 ohms. Half that value, or 2000 ohms, would be correct for 2 tubes push-pull or parallel. For CW or buffer operation the rectified grid current should be 40MA or more and for phone operation should be 55MA or more per tube. Under no conditions should the rectified grid current exceed the maximum rated value of 80MA. Expressed in terms of power approximately 20 watts of grid drive are required for CW or buffer operation or 30 watts for phone operation.

The 822 is the finest tube of its size for Class B audio. The maximum output shown on the chart is 700 watts. At that output under the conditions indication with sine wave input the average plate dissipation will be only 180 watts. The ratio of minimum plate voltage to maximum grid voltage is high making the tube extremely easy to drive. A pair of 2A3's or 6A3's are recommended as drivers and will furnish more than enough grid driving power with good voltage regulation.

814

The 814 is identical with the 822 except for the Mu or amplification factor and is intended for those applications where a tube of lower mu is desired. The mu of 12 is about optimum for grid modulated and class B linear R.F. operation. We recommend the 814 for efficiency modulated amplifiers.

A class B linear or grid modulated amplifier should be biased to approximately cut off. For an 814 operating at 2000 volts the correct bias voltage would be approximately 165 volts. This bias must be furnished from a source with good regulation such as batteries or a good rectified, AC bias eliminator. The coupling to the antenna must be very tight. The excitation should be adjusted until grid current just begins to flow on excitation peaks. While very little RF grid drive is required for an efficiency modulated stage the ratio of driver output to excitation required must be large to provide good driver regulation. This excess excitation should be dissipated in a resistive load such as resistors or lamps. The circuit diagram for an efficiency modulated amplifier is the same as that for a class C amplifier.

Because the plate efficiency of efficiency modulated amplifiers is low, usually about 33%, the input to and output from, such a stage will necessarily be much less than with the same tube operating class C. Assuming an efficiency of 33% the maximum permissible input to an 814 would be 300 watts, 200 of which would be dissipated on the plate and 100 watts delivered to the output circuit. This low plate efficiency is at least partially offset by the inexpensive modulation equipment necessary. The usual class B driver stage may be used to plate modulate the preceding stage for class B linear operation or to grid modulate the final.

For Class C operation the optimum value of bias resistor for one 814 would be 8,000 ohms. Half that value, or 4000 ohms, would be correct for 2 tubes parallel or push-pull. For CW or buffer operation the rectified grid current should be 30MA or more and for phone operation should be 55MA per tube. Under no conditions should the rectified grid current exceed the maximum rating of 80MA per tube. About 25 watts of grid drive are required for efficient CW operation or 35 watts for phone operation.

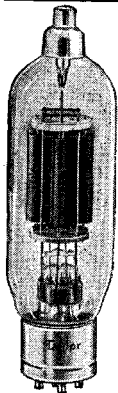

HD 203-A

150 WATTS PLATE DISSIPATION
CARBON ANODE

New Low Price!

Now— **\$14.50**

The Heavy Duty 203A is truly a heavy duty tube and was the first tube designed with the floating anode. Before the introduction of the HD 203A punctures and flashing over in the stems of the standard 203A were very common especially in Class B audio circuits. The HD 203A is a general purpose tube and is used in circuits built for 203A tubes where more power is desired.

GENERAL CHARACTERISTICS

Filament Voltage, volts.....	10
Filament Current, amps.....	4
Plate Resistance, ohms.....	5600
Mutual Conductance, uMhos.....	4800
Amplification Factor.....	25
Plate to Grid, mmf.....	12
Thoriated Tungsten Filament—NONEX GLASS	
Maximum Length, inches.....	9½
Maximum Diameter, inches.....	2½

CLASS "C" AMPLIFIER

Max. Operating Plate Volts.....	1500	1750
Max. D.C. Plate Current, mils.....	250	250
Max. D.C. Grid Current, mils.....	60	60

CLASS "B" A.F. MODULATOR

Push Pull Operation

D.C. Plate Voltage, volts.....	1500	1750
Grid Voltage, appr. volts.....	—45	—67.5
Load Resistance (plt. to plt.) ohms.....	9600	10,000
Max. D.C. Plate Current (2 tubes), mils.....	315	365
Static Plate Current, per tube, mils.....	18	18
Power Output (2 tubes), watts.....	300	400

Supply Voltage ↓	200	250	300	400	←Audio Watts Output
1750	.180 20,000	.225 16,000	.275 13,000	.365 10,000	←Max. Av. Ip. ←Load Impedance plate to plate
1500	.210 14,500	.265 11,500	.315 9,600		←Max. Av. Ip. ←Load Impedance plate to plate
1250	.255 10,000	.320 8,000	.380 6,900		←Max. Av. Ip. ←Load Impedance plate to plate

204-A

250 WATTS PLATE DISSIPATION
CARBON ANODE

\$60.00



The Taylor 204A is a three element air cooled power tube designed for use in transmitters as an oscillator, Radio Frequency Amplifier, and Class "B" Audio modulator. A Super Heavy Duty Carbon Anode is used which enables the tube to withstand overloads and still maintain stable characteristics. Because of its heavy duty construction and long life this tube is highly recommended for use in Broadcast transmitters where uninterrupted service is very essential. The characteristics of the Taylor 204A are standard. Detailed data will be supplied on request.

PERFORMANCE CURVE OF THE
TAYLOR 204-A
WILL BE SUPPLIED ON REQUEST

841-SW

50 WATTS PLATE DISSIPATION
CARBON ANODE
A POPULAR DIATHERMY TUBE

\$8.00

GENERAL CHARACTERISTICS

Type 841SW

Filament Voltage, volts.....	10
Filament Current, amps.....	2
Amplification Factor,	14.6
Maximum Length, inches.....	6¼
Maximum Diameter, inches.....	2½
Plate to Grid, mmf.....	9
Alsimag UX Base—NONEX GLASS	

CLASS "C" OSC AND POWER AMP

Max. Operating Plate Volts	
Unmodulated D.C., volts.....	1000
Max. D.C. Plate Current, mils.....	150
Max. D.C. Grid Current, mils.....	30
Max. Plate Dissipation, watts.....	50
Max. RF Grid Current, amps.....	5

OTHER TAYLOR TUBES

756
40 watts plate dissipation—carbon anode. Fil. 7.5 volts 2 amps. Plate 850 volts 110 MA amp. factor 20.

\$3.95

825
Same as 756 except amp. factor is 8.

\$3.95

203-B

Same characteristics as the 203Z except amp. factor is 25. Plate lead thru base.

\$7.00

HD 211C

150 Watt Diathermy Tube.....**\$14.50**

303C

150 Watt Diathermy Tube.....**\$14.50**

HD 203C

150 Watt Diathermy Tube.....**\$14.50**

Ask your distributor or write to us for information on use of Taylor Tubes as replacements in any Diathermy Machine.

Taylor

**CUSTOM
BUILT**

Tubes



866 — \$1.50

HALF-WAVE MERCURY VAPOR RECTIFIER TUBE

THERE ARE OVER 25,000 TAYLOR 866's IN USE IN COMMERCIAL BROADCAST AND AMATEUR RADIO TRANSMITTERS. TAYLOR 866's ARE KNOWN THE WORLD OVER TO BE THE LONGEST LIVED AND MOST TROUBLE-FREE 866's EVER MADE.

"WHEN YOU BUY 866's—SAY 'TAYLOR 866's' AND YOU'LL GET THE BEST."

The multistrand filament used in TAYLOR 866 Rectifiers has twice the emitting surface of the nickel alloy ribbon type filaments used in ordinary 866's. This multistrand filament together with the exclusive TAYLOR method of applying the oxide coating results in the coating adhering to the filament more closely. You have probably noticed how the oxide flakes off of ribbon type filaments—this cannot happen with the TAYLOR multistrand filament construction. The result is longer tube life. The greater filament area in the TAYLOR 866 gives increased ability to withstand heavier current overloads.

For over three years the TAYLOR 866's have been made with a Svea Metal Anode (chemically pure iron). Svea Metal does not amalgamate with mercury.

When back emission occurs in a Rectifier using a carbonized anode, small particles of carbon adhere to the filament ruining the filament emission. This condition cannot take place in a TAYLOR 866 Rectifier which has a Svea Metal Anode.

GENERAL CHARACTERISTICS

Filament Voltage, volts.....	2.5
Filament Current, amps.....	5.0
Inverse Peak Voltage, volts.....	7500
Peak Current, amps.....	.600
Appr. Voltage Drop per tube, volts.....	15
Multistrand Filament	Svea Metal Anode

WARNING: Do not use condenser input where the output voltage exceeds 1000 if the current is 200 milliamperes or more. Condenser input permissible at higher voltages at low current values.

SPECIAL NOTE

In transit mercury in tube splatters over filament—therefore when first placing this tube into operation filament should be lighted for fully 15 minutes to allow mercury to condense to bottom of bulb.

866 JR.

\$1.00

HALF-WAVE MERCURY VAPOR RECTIFIER



The 866 Jrs. fill a real need for intermediate power requirements. They are intended to be used as rectifiers in power supplies of from 600 to 1000 volts D.C. where the receiving type full-wave rectifiers will not stand up and where the power capabilities of the Heavy Duty 866's are not necessary. The smaller size of the 866 Jrs. is another feature that will prove to be of great advantage in the layout of compact power supplies.

866 JR.

GENERAL CHARACTERISTICS

Fil. Volts	2.5V
Fil. Current	2.5A
Max. RMS A.C. Volts	1250
Max. D.C. Current per pair (Choke input)	250 M.A.

PHYSICAL CHARACTERISTICS

Max. Length, Inches	5 1/4
Max. Diameter, Inches	2 1/4
	UK Ceramic Base

Connect Plate Terminal to Usual Position Standard On All UX Bases

866 JR.

The 866 Jr. uses the multi-strand filament introduced by TAYLOR TUBES. The multi-strand filament construction used in TAYLOR rectifiers has twice the emitting surface of the nickel alloy ribbon type filaments used in ordinary 866's. The longer life secured with TAYLOR heavy duty 866's has proven that the use of the multi-strand filament and of a svea metal anode results in better rectifiers.

BLEED RESISTOR SPECIFICATIONS

Output Voltage	Resistance In Ohms	Actual Dissipated Power In Watts	Recommended Resistor Wattage Rating
500	25,000	10	25
1,000	50,000	20	50
1,500	75,000	25	50
2,200	100,000	40	100
3,000	200,000	45	100

A heavy-duty resistor should be connected across the output of a filter in order to draw some load current at all times. This resistor avoids soaring at no load when swinging choke input is used and also provides a means for discharging the filter condensers when no external vacuum-tube circuit load is connected to the filter. This bleeder resistor should normally draw approximately 10 per cent of the full load current. The above table gives suitable values of bleeder resistors for power supply systems with from 500 to 3,000 volts output.

Taylor



Tubes

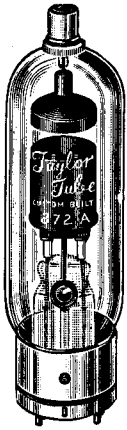

872-A

NEW! . . . BETTER!

**HALF-WAVE
MERCURY VAPOR
RECTIFIER TUBE**

New Low Price!

\$10.50

This new and greatly improved Taylor design incorporates the use of a Processed Carbon Anode and shield. Tried and proven in actual broadcast station use. A performance test will thoroughly prove the superiority of Taylor 872-A's. In a single phase full wave rectifier, with choke input, two 872-A's will deliver up to 2.5 amps. at 3500 volts D. C. Multi-strand filament.

CHARACTERISTICS

Filament volts	5.0
Filament current, amps.....	6.75
Inverse peak volts.....	10,000
Peak current, amps.	5.0
Approx. voltage drop per tube, volts.....	15
Standard 4 prong 50 watt base.	
NONEX T-18 (50 watt) BULB	

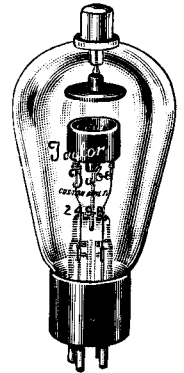

249-B

NEW! . . . BETTER!

**HALF-WAVE
MERCURY VAPOR
RECTIFIER TUBE**

New Low Price!

\$5.00

Like the New Taylor 872-A, this new rectifier tube uses a Processed Carbon Anode and shield together with the recognized advantages of Taylor's multi-strand filament. In a single phase full wave rectifier, with choke input, two 249-B's will deliver up to 1.25 amps at 3300 D. C. volts. An ideal tube for use in 1KW Amateur Transmitters. The Taylor 249-B is an exact replacement for Tubes with same type number.

CHARACTERISTICS

Filament volts	2.5
Filament current, amps.....	7.5
Peak inverse volts.....	10,000
Peak current, amps.....	2.5
Approx. voltage drop per tube volts.....	15
Standard UX base—NONEX BULB	

IMPORTANT INFORMATION

TESTING TUBES: As many of the tubes returned to us as defective test out OK here we want to make some suggestions that will enable every amateur to give doubtful tubes a partial emission test in his own transmitter. Most amateurs have or can easily obtain a 6.3 volt or 10 volt transformer. In the case of testing a tube which has a 7.5 volt filament, replace the 7.5 volt transformer with a 6.3 volt transformer. Then, without making any other changes, note the readings of the meters in the grid and plate circuits of the tube being tested. There should be only a slight drop in the plate current while the grid current may drop to 1/2 its former value and the tube would still be satisfactory condition. Should the grid current drop in excess of 1/2 the original value the filament emission can be considered as below normal and the tube should be returned to us for inspection.

In the case of 10 volt tubes when the filament voltage is dropped to 7.5 volts by substituting transformer, the grid current can be expected to drop to approximately 1/2 the normal value. Should the grid current drop in excess of 1/4 the original reading the tube can be considered as having low filament emission.

The above information is based on tubes being operated as class C amplifiers with the normal rated plate current flowing. Should a tube become defective for reasons other than filament emission such as glass failure or element lead wires damage the cause should be determined before replacing with a new tube. Glass failure in the case of tube with both grid and filament leads brought out through one press is usually caused by; excessive grid voltage, excessive R.F. grid current or approaching the upper frequency limit of practical operation without reducing the power input. In the case of plate leads the glass may be cracked from excessive R.F. current. The R.F. current in the plate lead increases directly with frequency and is particularly destructive in cases where V.H.F. parasitic oscillation are present. We suggest that attention be paid to the notes on the cause and cure of such oscillations in the Technical data on page 24 under heading of "Special data Unit No. 2".

Experience has proven to us that transmitting tubes can not be shipped via Parcel Post with safety. When tubes are returned for inspection pack the tubes very carefully and ship via Express.

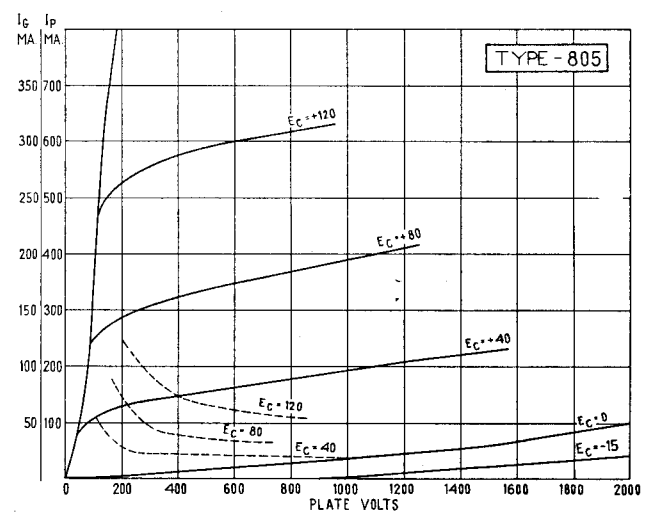
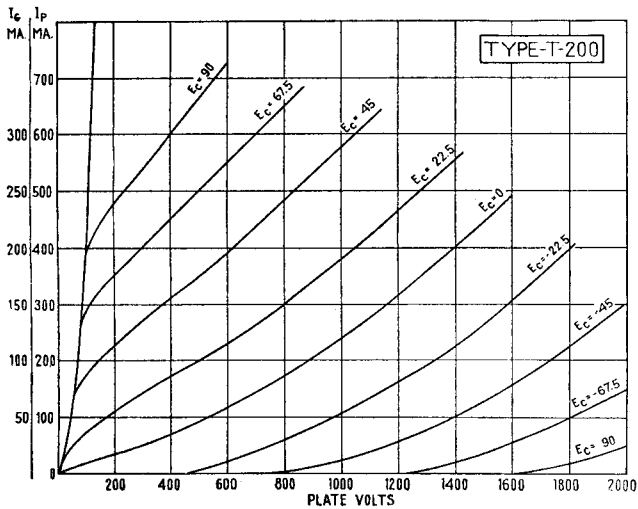
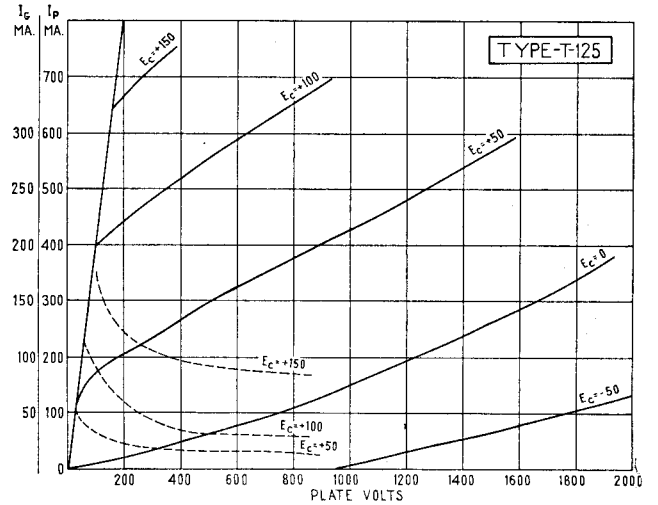
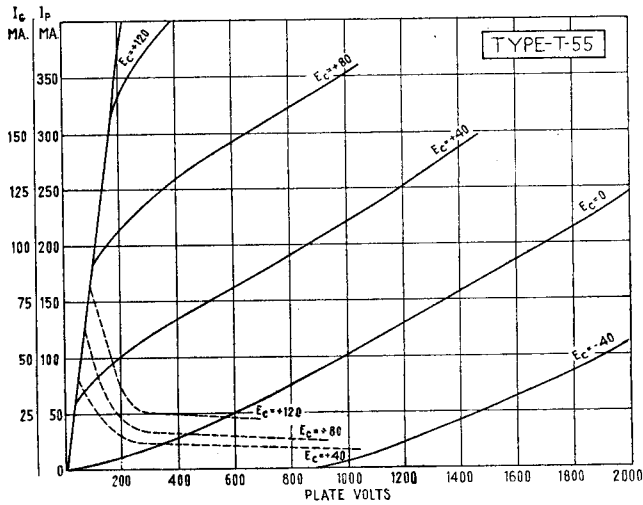
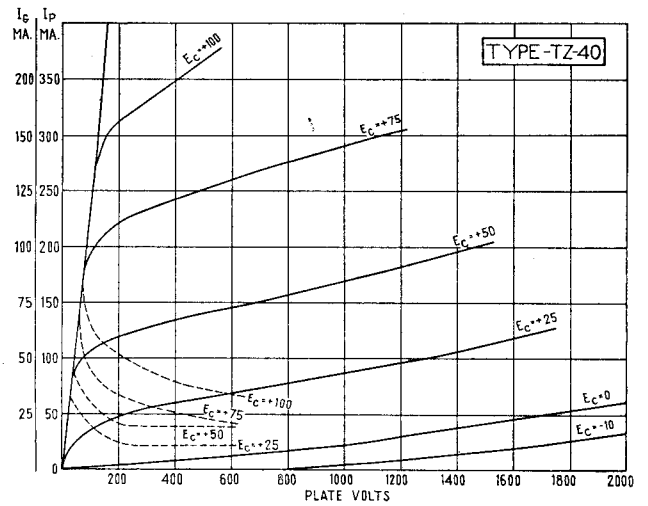
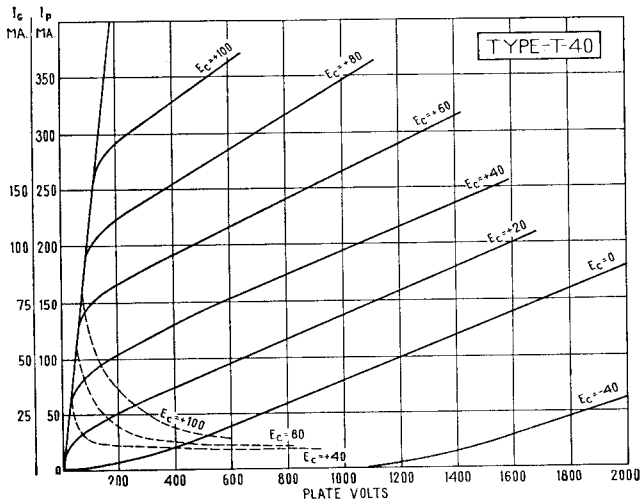

DETERMINING CORRECT VALUE OF C

The proper L/C ratio for any tank circuit can be easily calculated by the method outlined below.

First we must arrive at a value of Q for various types of service. The accepted value of Q for CW and buffer stage is 12, while for modulated Class C amplifier the value is 20. Values higher than 20 are not recommended.

Formulae for single ended unbalanced output stages:

$$C_{(mmf)} = \frac{Q \cdot 1,000,000}{2 \times 3.14 f(m) Z_L}$$

Formulae for balanced output and push-pull amplifier:

$$C_{(mmf)} = \frac{Q \cdot 1,000,000}{2 \times 3.14 f(m) Z_L \cdot 4}$$

The value of C obtained will be the effective value; hence where split-stator condensers are used the value of C per section will be two times the calculated value.

The load resistance of ZL can be obtained for all practical purposes by dividing the plate voltage by the plate current and multiplying by .4

$$\frac{E_b}{I_b} \cdot .4 = Z_L$$

In the case of balanced output or push-pull amplifiers, the load impedance becomes 4 times the above value. This is taken care of by multiplying ZL by 4 as in the above equation.

Example: Find C of a tank circuit for Q of 12 for a single T40 at Eb 1,000 V and Ib 100 MA. Output circuit to be of the balanced type and a frequency of 14 mc.

$$C = \frac{12 \times 1,000,000}{6.28 \times 14 \times Z_L \times 4}$$

$$Z_L = .4 \frac{1000}{.1} = 4000$$

$$C = \frac{12,000,000}{1,410,000} = 8.6 \text{ mmf.}$$

If the tank condenser used is of the split stator type, the amount of capacity per section will be 2×8.6 or 17.2 mmf. By knowing the minimum and maximum capacity per section of the condenser, a close approximation of the proper rotor position can be made that will give the above capacity.

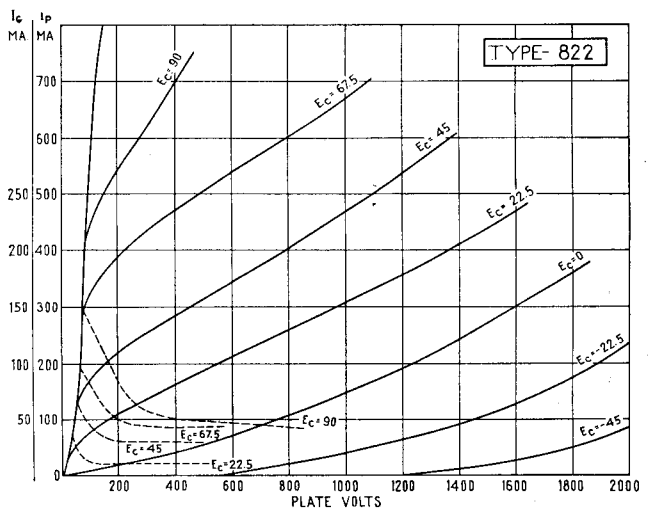
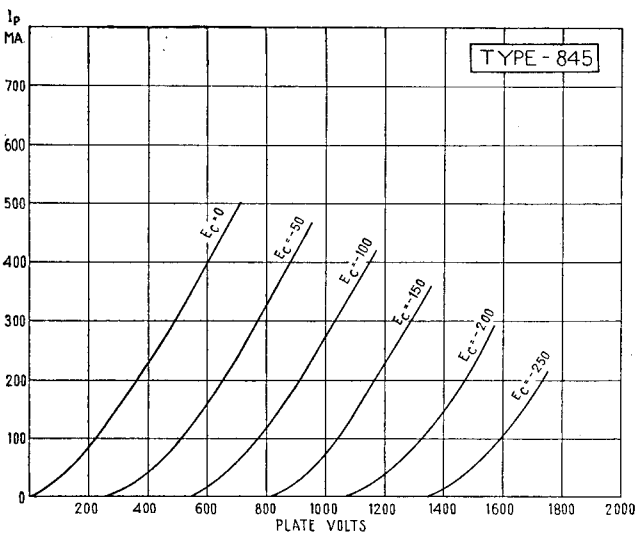
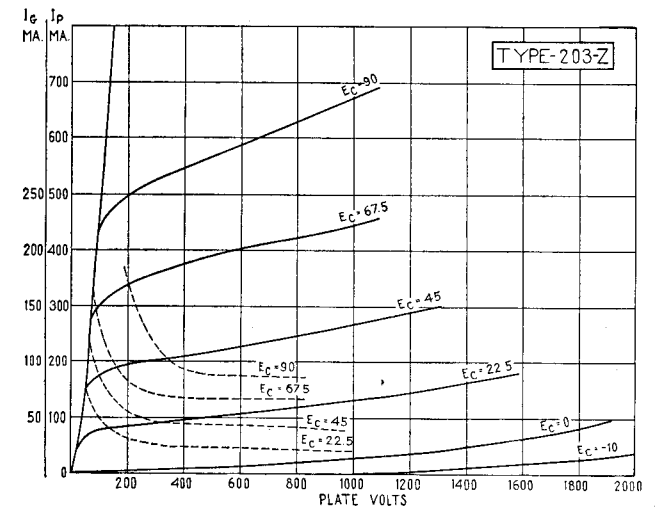
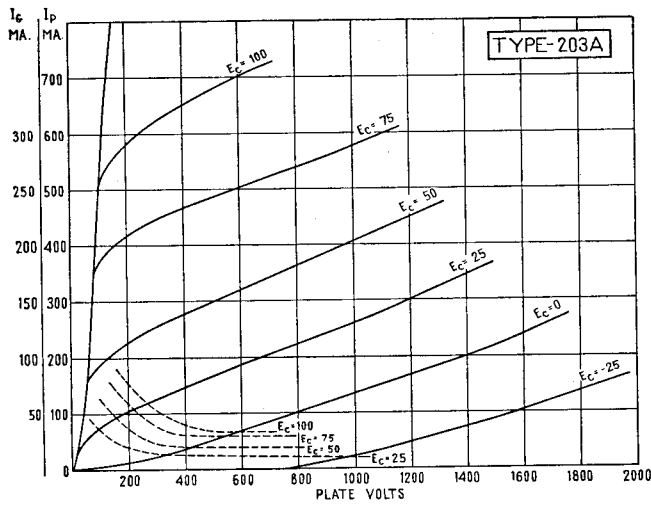
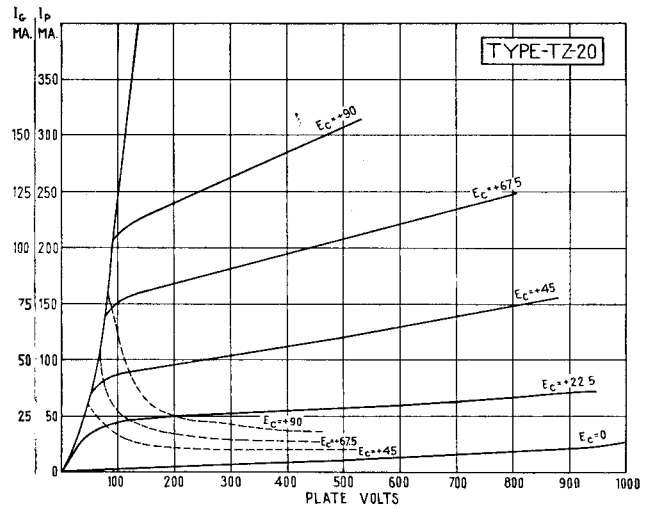
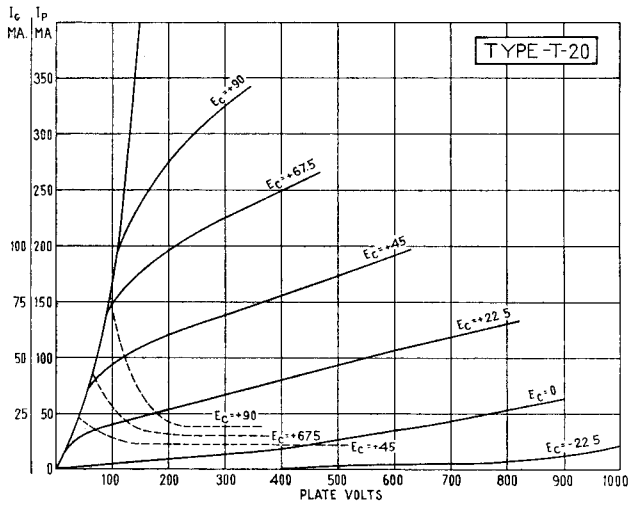

TRANSMITTER CIRCUITS AND DESIGN

The purpose of publishing the Taylor Tube Manual is to give to the users full technical information on our complete line of Tubes together with correctly designed, thoroughly tested Transmitter circuits in which the tubes can be successfully used. The transmitters shown in this Manual are, therefore, models built up for test and photographic purposes

and, with the exception of the chassis deal on the 275 Watt De Luxe Dual Unit Rig, no drilled chassis, templates or kits of parts are available. We give complete building instructions and use large size illustrations in this Manual to make the construction of these units a simple matter. If in constructing any of these units you experience any difficulty, you can secure

technical assistance from any Taylor Tube Distributor or from us. Every transmitter shown has been completely "QSO Tested" on the air on all its operating frequencies. Many hundreds of amateurs built Taylor Tube transmitters from our last Manual and the many letters of praise we have received testify to their successful operation.

Taylor



Tubes

GENERAL TUBE INFORMATION

In all Radio circuits the tubes are the most important factor and the choice of tubes should be given the fullest consideration before attempting to build up any apparatus.

SELECTING TUBES

In selecting the proper tube for the particular purpose for which it is to be used, the first consideration would be that of power rating and plate dissipation. It is sound economy to purchase tubes that will give the desired amount of power within the ratings since the overloading of tubes results in shortened tube life.

Attempting to operate tubes and circuits at higher than normal efficiencies is false economy. 75% efficiency in Class C is considered normal and can be easily obtained with TAYLOR TUBES at reasonable values of plate voltage, excitation, bias and L/C tank circuit ratios. In order to realize abnormally high efficiencies, all of these conditions must be changed. The excitation must be increased by several times which means that a larger driver tube must be used and perhaps another stage added. The bias must be increased to several times cutoff. The plate voltage must be increased to 1.5 times normal. The L/C ratio must be extremely high because the tank impedance has to be as high as possible and the tank and condenser losses reduced to a minimum. The entire process is very expensive and the result is an improvement of 5% to 15% (maximum) in efficiency. The plate current must not exceed the rated value, the increase in input being gained by increasing the plate voltage. Raising the excitation, bias and L/C ratio inevitably result in excessive harmonic content, a condition which is very undesirable.

INTER-ELECTRODE CAPACITIES:

The next consideration should be that of inter-electrode capacities. If the transmitter is to be used on more than one frequency, your selection should be a tube whose capacities will permit efficient operation on the highest frequency to be used. The tube will then operate on all lower frequencies with equal efficiency.

Because of the great interest in high frequency operation most of the newer tubes have featured low interelectrode capacities. There are two reasons why this type of tube is better for the higher frequencies. The first is the fact that the RF current through a given capacity is proportional to frequency if the voltage is constant. This refers to the RF current which flows in the Grid and Plate leads and not to the direct current which you read on your meters and is the current that often causes the failure of medium C tubes at the very high frequencies. Reducing the inter-electrode capacities allows operation on a proportionally higher frequency for a given safe amount of RF current. You, no doubt, have noticed that where medium C tube operation on high frequencies is specified, the permissible maximum safe applied input becomes less as the frequency becomes greater because lower applied voltages mean proportionally less RF current; therefore, the plate input must be limited to the point where excessive current cannot flow. Excessive RF current will burn off grid or plate leads or cause punctures in the tubes where the leads enter the glass envelope.

The second reason for the use of low C tubes at the high frequencies, is the fact that the tube capacities themselves may be high enough to prevent a suitable L/C ratio in the tank circuit making it impossible to use a tank circuit with enough impedance to permit efficient operation.

Low C in a tube is obtained partially by isolating the grid, plate and filament leads from each other, but most of the capacity reduction is accomplished by using comparatively small elements and

increasing the separation between them. However, increased spacing between elements leads to a disadvantage as well as the advantage gained. This increased spacing means that for a given plate current the voltage drop across the tube will be higher. Low C tubes because of their high voltage drop require a higher plate voltage than medium C tubes in order to realize the same efficiency. The amount of RF grid drive required for the low C tube will be greater than required for the medium C tube assuming, of course, that the tube is used at a frequency where it will operate efficiently.

AMPLIFICATION FACTOR:

The amplification factor is the ratio of change in plate volts to change in grid volts necessary to maintain a constant plate current, and can be simply described as the increase in plate volts required to keep the plate current unchanged when the grid bias is increased one volt.

To calculate the amplification factor of any tube, using a Class A circuit, apply a plate voltage with a set bias and note the plate current value. Next, increase bias one volt and then increase plate voltage until the plate current value is brought up to the original value, since an increase in bias will decrease the plate current. The number of plate volts required to bring the current value back to original reading will be the amplification factor.

MUTUAL CONDUCTANCE:

Mutual conductance has some relationship to amplification factor or Mu since it also involves plate current change by grid voltage change over a small range and is expressed in mhos which is the inverse of ohms. The mutual conductance of a tube in micro mhos is the ratio of amperes plate current change to volts grid voltage change $\times 1,000,000$. For example, a tube whose plate current changed 5 MA with a grid voltage change of 2 volts would have a mutual conductance of:

$$.005/2 \times 1,000,000 = .0025 \times 1,000,000 = 2500 \text{ micro mhos}$$

Another way to calculate mutual conductance is to divide the plate resistance of the tube by the amplification factor.

PLATE RESISTANCE:

The plate resistance of a tube is the ratio between a small plate voltage change to the plate current change it effects. Assuming that in a given tube a change in plate voltage of 50 volts caused a change in plate current of 5 MA, its plate resistance would be:

$$50 \div .005 = 10,000 \text{ ohms}$$

CALCULATING BIAS

To calculate necessary bias for a Class "C" stage (any type tube) divide the plate voltage by the amplification factor and multiply by two for approximate double cutoff. For higher efficiency add at least 40% more to this figure. For C. W. Class "C" or buffer stages, multiply by 1.5.

For example take a 203A tube which is to be used as an amplifier with 1000 volts on the plate. This tube has an amplification factor of 25

$$\frac{1000}{25} = 40 \times 2 = 80 + 32 (40\%) = 112 \text{ volts}$$

necessary for double cutoff plus 40% for phone operation.

For CW

$$\frac{1000}{25} = 40 \times 1.5 = 60 \text{ volts}$$

TRANSMITTERS

The principle aim of the Taylor Tubes, Inc., has been to manufacture for the Amateur transmitting tubes that will deliver More Watts Per Dollar. With this in mind, our engineering staff has developed the following line of transmitters so that the Amateur may obtain More Output Watts Per Dollar from his transmitter as well as from his choice of Taylor Tubes.

Whether you desire low, medium or high power, on any amateur band you will find herein a circuit to fill your requirements.

Each and every transmitter was built and put into actual operation. In some instances, models were demonstrated at Conventions and Hamfests. From the comments noted, we sincerely feel that these transmitters have the stamp of approval of the Amateur.

TRANSMITTER CONSIDERATIONS

A transmitter which presents a neat and workmanlike appearance is a great source of satisfaction when visitors drop in. Not only is neat appearance desired, but stability, in the sense of reliability, dependability and consistency, is a very important requisite.

A dependable and stable transmitter is not difficult to construct; the use of good components and good design are the major requirements. Each stage must function properly with no interaction between it and other stages and should be free of spurious or parasitic oscillations or regeneration except in the case of a frequency doubler where regeneration is important and almost indispensable. The transmitter must have a sufficient number of stages so that more excitation is present at the grid of each tube than is actually required. This point is of particular importance yet there should not be more stages than are necessary to accomplish a reasonable surplus of excitation. It is almost mandatory that trick circuits be avoided since they usually involve critical adjustments.

Each layout which we recommend fulfills the foregoing requirements. If the layouts are duplicated no spurious or parasitic oscillations should be present, no regeneration is used except where desirable or necessary, and the amount of excitation available at any given point is about twice the amount used or required at that point. In some cases this means that one stage might be eliminated, at least on some bands, without appreciable reduction in output; but doing so might not permit the smooth stable operation which is so important.

In general, for transmitter use, Taylor triodes combine low cost, efficient operation, ease of adjustment, and ruggedness to an extent which must make them the Amateur's choice

CIRCUITS

Basically, the requirements for a triode amplifier are an input circuit capable of being tuned to the desired operating frequency, an output circuit capable of being tuned to the same frequency, a source of RF voltage of opposite phase for neutralization, and suitable sources of filament, plate, grid and excitation voltages.

Starting with the grid circuit, the plate circuit of the preceding stage may also act as the grid coil for the amplifier under consideration. See Figure 1. This is the case when capacity coupling is used. The advantages of this system are its low cost and simplicity. If the impedance of the grid circuit is approximately the same as that of the driver plate circuit this coupling system is equally as efficient as any other, at least on the three lowest frequency bands. On 20 meters and higher frequencies the combined input and output capacities plus the capacities of associated equipment to ground may be high enough to prohibit the use of enough inductance in the circuit and the plate efficiency of the driver stage may become poor. If the grid impedance of the driven stage is lower than the plate impedance of the driver stage maximum efficiency may be obtained by tapping down on the plate tank at a point which gives maximum grid drive at minimum plate current to the driver stage. Such an arrangement will provide maximum power efficiency but it is not commonly used since it usually creates new circuits which invite oscillation at parasitic frequencies.

In cases when the plate impedance of the driver stage is sufficiently different from the grid impedance of the driven stage to prohibit using the same tuned circuit for both or where the

capacities resulting from this connection would be too great it is common practice to use a separate tuned circuit for the plate of the driver stage and the grid of the driven stage. The coil may be placed in the field of the driver plate coil or it may be placed out of the direct field of the plate coil and coupled thru a low impedance line. This latter method is usually called link coupling. See Figure 2. Inductive coupling in one of its forms is usually of greatest advantage at the higher frequencies and when working from a single ended stage to a pushpull stage and from a pushpull stage to a single ended one and when the driven grid impedance is widely different from the driver plate impedance. A further advantage is the elimination of or minimization of the importance of RF chokes. The disadvantages are higher cost because of more parts, greater space requirements, and more tuning adjustments and coils to change when shifting bands.

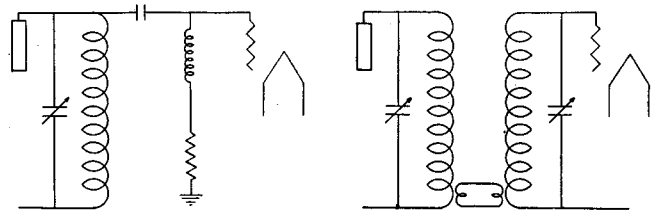

Fig. 1

Fig. 2

Your choice of an input circuit will depend upon all of the considerations previously mentioned and when not duplicating a complete unit already designed the various factors should be weighed carefully that an intelligent selection may be made. The present trend toward link coupling is probably due to the fact that with it best results may be obtained under most any conditions even tho the cost is higher and the complexities greater.

Your plate circuit considerations are quite well determined for you in advance. The important considerations are the L/C ratio to provide maximum unloaded tank impedance consistent with minimum harmonic content and if fone is used to have sufficient capacity in the circuit to provide for linear action under modulation.

Neutralization also ties in with grid circuit and plate circuit design, except in the case of push-pull. With push-pull the fundamental circuit arrangement is identical whether the stage is a tuned grid tuned plate oscillator or a neutralized amplifier. The only practical method of neutralizing a push-pull stage is the so-called cross neutralizing method employing two neutralizing condensers, each connected from one grid to the plate of the other tube. See Figure 3.

However in a single ended stage either of two methods may be used. With grid neutralization the center of the grid coil is at ground RF potential. See Figure 4. One end of the coil goes to the grid of the driver tube and the other end to one side of the neutralizing condenser. Grid neutralization will usually operate satisfactorily and may be of advantage if an unbalanced output stage is desirable. However, the grid of the tube puts a resistive load across half of the input coil resulting in the opposite end of the coil being other than 180° out of phase if the coupling in the grid coil is less than unity. Unity coupling is never realized in practice at radio frequencies but satisfactory neutralization may usually be realized if the turns of the grid coil are wound as close together as possible. If difficulty is experienced it will usually be at the higher frequencies.

Plate neutralization of a single ended amplifier necessitates operating the center of the plate coil at ground RF potential. One side of the neutralizing condenser is connected to the opposite end of the plate coil to which the plate of the tube is connected and the other side of the neutralizing condenser goes to grid. See Figure 5.

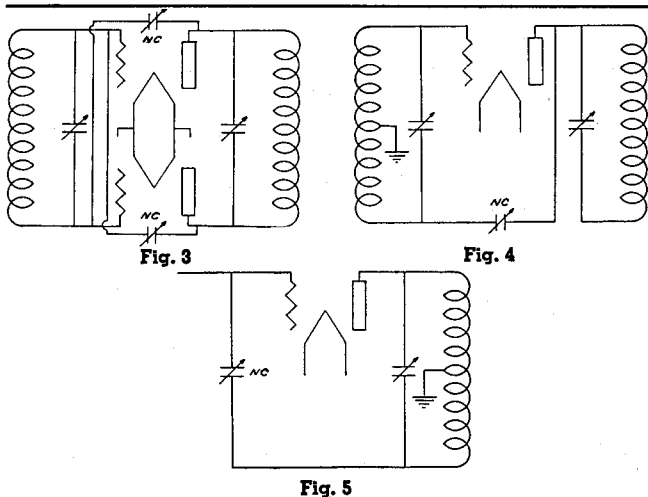

For maximum power gain with reasonable efficiency the bias should be approximately cutoff and the grid current the normal recommended value. An amplifier of this type is suited for use as an intermediate or buffer stage or as the final stage in a CW transmitter.

Class C operation requires somewhat greater than twice cutoff bias with normal recommended grid current. This stage would be characterized by slightly better plate efficiency than the one previously described and would be suitable for intermediate or buffer stage, final stage CW, or plate modulated phone.

Another type of Class C operation would require bias of several times cutoff with normal grid current flowing. With the plate circuit tuned to the same frequency as the grid circuit and with a high impedance plate tank, higher voltages may be applied and higher plate efficiencies, over 75% obtained. However, the harmonic content will be high and unusual precautions to prevent harmonics being radiated by the antenna must be taken. This grid bias and excitation condition is also ideal for the operation of a doubler stage with the plate circuit tuned to twice the frequency of the grid circuit. Reasonable efficiency may be obtained from a doubler if the bias and excitation are high.

The Class B linear of grid modulated amplifier requires approximately cut off bias and little or no grid current. The unmodulated efficiency will be low, varying between approximately 25% and 35%. This type of operation necessitates the use of fixed voltage bias sources. The voltage must remain constant regardless of current variations. Batteries are probably the most satisfactory source because the smaller types may be used and the life will be long.

For all other types of operation it makes little or no difference how the necessary bias is obtained. The simplest and cheapest method is the use of a resistor in the grid return circuit. This arrangement is entirely satisfactory in every respect except that no protection is afforded the tubes in the event the excitation fails or is removed while the plate voltage is on. Batteries are frequently used and they make an excellent bias source from every standpoint except that of cost, life, and in some cases, size. The same amount of power which would be dissipated in a resistor in the same circuit is dissipated in the batteries. This heat dries out the batteries so rapidly where any great amount of grid current is present that the use of batteries can become very expensive.

Bias supplies of one type or another are becoming more common. A discussion of the units would be too involved and lengthy for the space available. Let it suffice to say that even the simplest types should prove entirely satisfactory for RF stage bias since regulation, except in the case of efficiency modulated amplifiers, is not a factor.

Cathode bias also is used. It consists of a resistor between filament center tap and ground. It must be capable of carrying the total grid and plate current and as the plate current is increased the bias also increases. If the stage is modulated the resistor must be by-passed with a large condenser in addition to the RF by-pass which is required anyway. The principal use for this type of bias is to protect the tubes in case of excitation failure. Without excitation cutoff bias can never be reached. The drop across the resistor must be subtracted from the supply voltage to give the actual plate voltage.

The most common arrangement which takes advantage of the best features of each type of bias supply is usually enough pack or battery bias to provide cutoff with no excitation and the balance by resistors. It is particularly important in a CW transmitter to have all stages following the keyed stage biased to cutoff. In the

phone transmitter where the plate voltage is off during standby periods enough cathode bias to limit the plate current to a reasonable value plus resistor bias for the balance makes an excellent arrangement.

Grid current should never be permitted to exceed the maximum rated value. If high drive is required or desired the bias should be increased to the maximum which will allow normal recommended grid current to flow. In this manner you may increase grid excitation without greatly effecting tube life.

If any type or combination of types of bias are used they may be measured by connecting a voltmeter from the filament center tap to the grid side of the last source of bias in the circuit. The measurement should of course be made with plate voltage applied to the stage and everything operating under normal conditions. If the rectified grid current and the value of the resistance in the circuit are known the bias will be the product of the two. If any cathode bias is used due allowance should be made for the plate current thru the amount of cathode resistance used.

CRYSTAL OSCILLATOR

In selecting a crystal oscillator circuit we had 5 requirements in mind.

1. High output on fundamental and second harmonic frequencies.
2. Minimum number of coils to wind and change.
3. Minimum number of tuning controls.
4. Lowest current thru crystal for best frequency stability and crystal safety.
5. Lowest cost consistent with maximum performance.

Every popular crystal circuit was set up for comparison. The one selected using a T21 was first popularized by Jones of Radio Handbook. It fulfills the first, third and fifth requirements perfectly and to a greater degree than any other circuit. It has only one tuning adjustment and one coil to change. The tri-tet its nearest competitor, has two coils to change and two tuning adjustments. With a 40, 80, or 160 meter crystal working straight thru the oscillator output will be about 15 watts. With a 20 meter crystal it will be about 10 to 12 watts. The 40 meter output from an 80 meter crystal will be about 12 watts and the 20 meter output from a meter crystal will be 6 to 9 watts.

In this circuit a good crystal is required for harmonic output. It must not only be active but must have only one frequency. 20 meter crystals will be very satisfactory in the circuit for straight thru operation but do not provide satisfactory 10 meter output. Most 20 meter crystals are 60 meter crystals operating on their 3rd harmonic. In this circuit the 10 meter output is apparently the 6th harmonic of 60 rather than the second harmonic of 20.

When not oscillating the T21 will draw about 140MA. With the crystal oscillating and the plate circuit off resonance the current will be about 100MA. When the plate circuit is brought into resonance on the fundamental or harmonic frequency a very pronounced dip in plate current will be noticed.

The fact that we prefer this crystal circuit does not mean that it has to be used. There is probably more difference of opinion concerning which is the "best" crystal oscillator arrangement than there is concerning any other unit in the transmitter. If you prefer the tri-tet because it works best for you, by all means use it. However, the circuit as shown delivers 20 to 25MA of grid current to the following stage even on 20 from a 40 meter crystal and the circuit used should do equally as well if equivalent results are expected.

DOUBLERS

As a doubler the plate efficiency of a stage will be much less than when working as a straight amplifier. Consequently for a given plate dissipation the output must be much less. More grid drive is required also so the power gain will be less. The grid bias should be several times that for straight thru operation. The L/C ratio should be as high as possible.

If a stage is used for both straight thru and doubler operation it may be neutralized and the neutralizing condenser setting left the same for doubler operation. If it is used for doubler operation only, the neutralizing condenser adjustment should be for maximum efficiency without oscillation.

L/C RATIOS

Your tank circuits are worth your careful consideration for they will greatly influence the operation of your transmitter. As far as the tubes are concerned the inductance and capacity in the circuit when tuned to resonance are a resistance as shown in Fig. 1. With no load coupled to the tank, the impedance (AC resistance) should be high and its value will be proportional to $\frac{L}{CR}$ where L is the amount of inductance, C the amount of capacity, and R the resistance. When you couple a load to the tank you have the situation shown in Fig. 2. R_{p1} is the unloaded impedance of the tank circuit. R_{p2} is the load impedance reflected across R_{p1} , and the

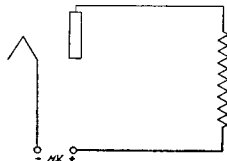

Fig. 1

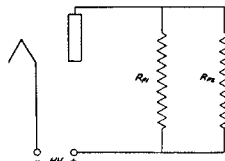

Fig. 2

power developed across R_{p2} will be delivered to the load or antenna. It is useful output. However, the power developed across R_{p1} is power wasted in the tank circuit and shows up in the form of heat. It may easily be seen that as the ratio of R_{p1} to R_{p2} is raised less power will be wasted and more will be delivered to the load. Because R_{p1} is the unloaded tank impedance it can be seen why, as the impedance of the tank circuit is raised less power will be wasted in the tank and more delivered to the load. As shown from the formula L/CR the impedance may be increased by increasing the amount of L and reducing the amount of C. If efficient coils and condensers are used it probably would not be practical to attempt to reduce R but if C were reduced to $\frac{1}{2}$ its former value, L would have to be doubled to hit resonance at the same frequency so the impedance would have increased to four times its former value. Actually, it would not be four times because R would increase slightly with an increase in L but the gain in impedance would approach four.

From the foregoing it would seem advisable to use as much inductance and as little condenser as possible. From a plate efficiency standpoint only this is more or less true, however, after a certain value of tank impedance is reached the efficiency increases only very slightly, yet the driver power required continues to increase and from an over-all efficiency standpoint there might be no improvement.

However, increasing the L/C ratio leads to one disadvantage for CW operation and an additional disadvantage for fone operation.

As the L/C ratio is increased the harmonic content is also increased. If these harmonics reach the antenna, and it is sometimes difficult to prevent them from doing so, they will be radiated and may cause interference to other services. Consequently it is necessary to select an L/C ratio which must necessarily be a compromise between plate efficiency and harmonic content. Fortunately, a ratio may be selected which does not result in appreciably lower efficiency yet the harmonic content is kept at a reasonably low value. In fact measurements seem to indicate that excessively high L/C ratios do not result in increased fundamental or useful output. The increase seems to be composed entirely of harmonics which are not useful and are to be avoided.

For phone operation a certain amount of capacity is necessary if the amplifier is to be linear. Less than this minimum of capacity will result in distortion and carrier shift. This amount of capacity is usually somewhat greater than the amount required to reduce harmonics to a satisfactory value and for this reason different L/C ratios have sometimes been specified for CW and phone operation. However, the permissible L/C ratio for fone is high enough that increasing it to the permissible CW value for that type of operation results in so small an increase in efficiency that it seems desirable to specify L/C ratios for all forms of operation which are capable of linear phone operation to permit modulation if desired and to

obtain greater harmonic suppression. However, if only CW operation is contemplated the L/C ratio may be quadrupled by using about half as much capacity and twice as much inductance as would be required for phone. Twice as much inductance may be obtained with about 41% more turns.

Correct L/C ratios become the greatest problems on the highest and lowest frequencies when all band operation is desired. For example, any condenser with enough capacity to provide a reasonable ratio on 160 meters would undoubtedly have a minimum capacity so high that efficient operation would be impossible on 10 whereas a condenser with suitable capacities for 10 meters would have so low a maximum capacity that poor linearity and high harmonic content must necessarily be present on 160 even though the efficiency would be good on both bands. Probably the most satisfactory answer to this problem would be to build the circuit for the highest frequency to be used and connect another condenser in parallel with the HF tuning condenser for low frequency operation.

If your L/C ratios are correct you will obtain maximum fundamental frequency output with minimum harmonic content and minimum distortion if modulated. If your L/C ratios are not correct you will sacrifice one or more of these desirable characteristics.

In general if your L/C ratios are right the minimum plate current with no load coupled to the output circuit will be about 10 to 20% of the loaded value. Minimum plate currents in excess of 25% of the loaded value are usually an indication that circuit losses are higher than they should be. However, tank circuit losses drop rapidly as the loading is increased so minimum plate currents unless greatly excessive need not be taken too seriously.

Optimum L/C ratios are not directly a function of the type of tube or tubes used. The factors used in the calculations are plate voltage, plate current, frequency, and the type of operation.

ANTENNA COUPLING

The method of coupling the transmitter to the antenna will depend upon the type of feeder system used and the characteristics of the antenna coil will depend upon the impedance of the feeders at the transmitter. Because there are so many variables we cannot provide any quantitative data. In the case of untuned transmission lines the correct number of turns in the pick up coil will be the number which will load the final to the desired input. With tuned feeders the characteristics of the antenna coil will depend upon the amount of inductance necessary to tune the antenna system to resonance. With single wire fed or end fed antenna systems, a separately tuned circuit coupled to the final tank is probably advisable because of the lack of harmonic discrimination with these antennas. If the L/C ratio in the final stage is low enough for reasonable harmonic suppression the L/C ratio of the separately tuned coil may be very high.

Any pick up coil coupled to a tank circuit should be placed at the point of minimum RF voltage to minimize capacity coupling. In the case of a balanced output tank as with push pull or a plate neutralized single ended stage the coupling coil should be at the center of the output tank. With a grid neutralized single ended final stage the coupling coil should be at the cold end of the tank coil.

A faraday screen between tank and pickup coil is usually very helpful in preventing even harmonic radiation but sometime presents mechanical difficulties if the coils are changed for multi-band operation. Grounding the center of the pick up coil to the final stage filament or ground circuit is usually equally effective and far more simple mechanically.

With transmission lines it is legal to tap the feeders, single or double wire, directly onto the final tank but this is likely to result in high mutual impedance between plate circuit and radiating system at the harmonic frequency. It is almost impossible for this condition to exist with a two wire line and a pick up coil whose center is grounded so it would be wise to avoid direct coupling and to use a two wire line to keep harmonic radiation at a minimum.

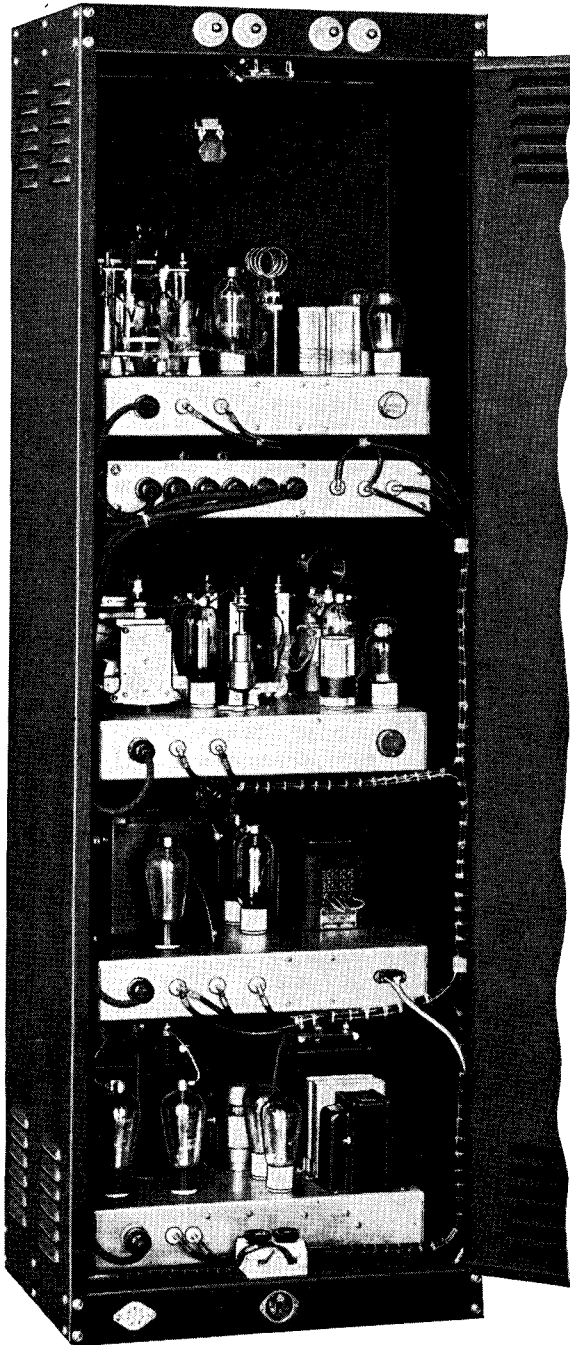

Taylor

★ ★ ★ ★

**ALL-BAND
DE LUXE
TRANSMITTER**

**275 WATTS
INPUT
PLATE MODULATED**

**INSTANT
CHANGE
ON TWO BANDS
AND
RAPID CHANGE
TO ALL OTHERS**

**COMPLETE SET
OF PARTS
ONLY
\$290.00**

**OBTAINABLE
AT ALL
TAYLOR TUBE
DISTRIBUTORS**

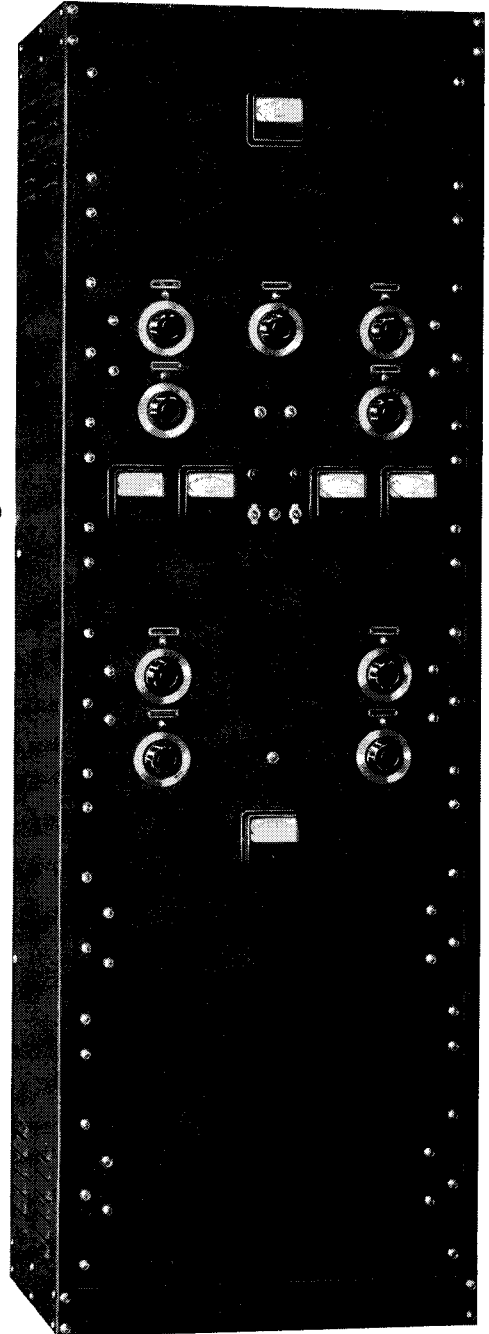

Drilled Chassis Furnished Free!

THIS OFFER EFFECTIVE IN U. S. ONLY AND EXPIRES JUNE 1ST, 1939

Here's the **newest** and most **modern** designed Amateur Transmitter — incorporating many ideas gathered from discussions with hundreds of Amateurs from all over the country. Since completion of the Rig many Amateurs have seen it and the comments were so unanimously enthusiastic that we decided to make this Transmitter available for easy construction at a new low price standard. All apparatus used and recommended are in line with Taylor's "More Watts per Dollar" value and the appearance and performance on all Bands meets Broadcast Station standards. **A complete set of four high quality steel chassis, with all socket and other large holes already drilled, will be furnished free of charge through your Distributor** when you purchase the complete set of tubes for this Transmitter. This bulletin gives full technical information.

FEATURES OF THE TAYLOR DE LUXE DUAL TRANSMITTER

TWO COMPLETE RF UNITS

offering High Efficiency performance on

ALL BANDS—5 METERS TO 160 METERS

one RF Unit for 20, 40, 80 and 160 and the other for 5, 10 and 20 meters.

Using a separate and complete RF unit for low frequencies and another for high frequencies makes possible, as in no other manner, correct L/C ratios with due regard to the linearity which is necessary for good fone operation.

INSTANT BAND CHANGING

from one RF unit to the other by the flip of one Toggle switch. You set the two RF units on any such bands you desire to operate on such as 160 meters in low frequency unit and 10 meters in the high frequency unit and you can change coils for operation on any other bands within two minutes time. TZ-40 tubes were chosen because their Zero bias features eliminated any necessity for bias supplies and also avoided the loss of input power that occurs when a cathode bias resistor is used. The TZ-40's also are slightly easier to drive and this helps considerably in the case of the TZ-40 doubler because a high gain tube doubles most efficiently.

FULL INPUT ON ALL BANDS

Although the normal rating of the Taylor TZ-40 is 115 watts input at 1000 volts, we have found, and thoroughly guarantee, that TZ-40's will give increased power at 1250 volts without any loss of life. In this transmitter, 1250 volts is used on the P.P. Final amplifier TZ-40's as well as on the Class B modulator TZ-40's. Operation of the final amplifier at 110 MA per tube or a total of 220 MA for the two tubes gives an input of 275 watts which can be used on all Bands including 5 meters without overloading the tubes. In every stage, the tubes are operated conservatively and if you have built the rig correctly using good parts, no color will show in the anodes because the plate dissipation rating will not be exceeded. The 1250 volts is reduced to approx. 850 volts on the TZ-40 Buffer Doubler stage through the use of a 5000 ohm 100-watt Ohmite resistor.

ALL DRILLED CHASSIS FREE

Your Distributor will give you free of charge a set of chassis when you purchase a complete set of Taylor Tubes for this Transmitter.

The Chassis have all socket and grommet holes punched. All small holes are left undrilled to allow the use of such equipment

which you may have on hand or a choice of using equipment other than shown. The accompanying photos show placement of parts very clearly and for this reason templates are not necessary and are not furnished.

NEW LOW COST

The new price standard that this Deluxe transmitter arrives at, is possible due to the availability of the Taylor TZ-40's which established a new conception of "More Watts per Dollar." Secondly, the idea of having two complete RF units with one set of power supplies, meters and modulator equipment means that you actually have two entirely complete rigs at approximately one-half the former cost.

MODULATOR WITH PEAK COMPRESSION

TZ-40 tubes are used in the Class B modulator unit as their advantages and value are obvious. Peak compression was incorporated as in the opinion of the Taylor engineers this feature is most desirable for amateur phone operation. The Waller (W2BRO) system met our approval and as the Thordarson Engineers had just announced a new special Amateur speech amplifier kit, their No. T17K20 including this type of peak compression control, we decided to specify the Thordarson unit as offering exactly what we would have built, and at an extremely reasonable price. Undoubtedly other transformer Manufacturers will shortly announce speech amplifier kits with the peak compression feature and such units will serve as well as this Thordarson kit. Experiments proved that a standard 866 performs perfectly as the control voltage diode rectifier in place of the 879 specified in some articles. Complete information on the speech amplifier is furnished by Thordarson so we will not repeat that information in this bulletin. We show an illustration of the T-17K20 kit to give you an idea of its appearance. See page 32.

REMOTE CONTROL

For ease of operation, a relay is supplied on the meter and switching chassis so that plate voltages can be controlled at a remote operating position. The leads for this as well as for keying, 500 ohm line and peak compression control voltage are brought out near the bottom of the rack through a convenient socket and plug arrangement. A.C. input to the rig is brought in through a recessed receptacle with the plug fitting on the cord so that no electric cord will be in the way when the rig is moved.

COMPLETE CONSTRUCTIONAL DATA

We will describe in detail the construction and purposes of each individual unit and give exact information as to what "kinks" we ran into so that you will be able to "go on the air" with the least possible trouble and effort. So simple and conventional is this hookup that only two small difficulties were encountered. Parasitics in final and hitting resonance on 5 meters. This is explained further in this article.

UNIT NO. 1—ANTENNA TERMINAL AND METER PANEL

This is the top unit in the rack and no chassis is used. An 0 to 5 Triplett Illuminated RF Ammeter and a Ward Leonard Special Mycalex insulated 250 watt capacity antenna relay are used to accomplish switching of the RF Ammeter to the antenna desired, automatically. Two sets of Johnson Feed-thru insulators are mounted on the rear of the rack to which can be left permanently installed any two desired antennas. A Class A license Amateur might have a 20 meter antenna and a 75 meter antenna connected for instant use and the Class B Amateur might have 160 meter and 10 meter antenna connected. In other words, any two antennas can be connected—ready for instant change by the flip of the same toggle switch that actuates the choice of RF units. The RF ammeter, relay Feed-thru insulators are connected to the swinging links of the output stages of the two RF units by the required lengths of the new Amphenol Flexible Coaxial Cable. This system provides for any antenna that can be fed by low impedance transmission lines. There is sufficient space left on the panel and to the back of it for mounting variable condensers and coils if an Antenna tuning unit is desired for tuning transmission lines. A Bud 7" Black Crystalline finish Masonite panel is used as it was found

that when operating on 5 meters there was danger of damaging the RF ammeter if a metal panel was used.

SPECIAL DATA—UNIT NO. 1

The Relay is suspended from the top of the cabinet by means of two Johnson 1½" Alsimag Cones and the Thermo couple also suspended by means of two Johnson 1" Cones.

UNIT NO. 2—HIGH FREQUENCY RF CHASSIS

This is the 12¼" panel and 17" x 13" x 3" chassis next below the antenna panel and it houses the complete RF stages from Crystal to Final Amplifier for the 5, 10 and 20 meter unit. The panel is Bud No. 1256A 12¼" and the chassis is 13" x 17" x 3". Several months were devoted to extensively studying all Crystal circuits and for this unit where both fundamental or harmonic operation of the crystal may be used, it was decided that the Jones regenerative oscillator was the proper circuit. Referring to Condenser C-1 (.0001) which controls the amount of regeneration, it was found that this value was optimum for normal crystals. For slightly inactive crystals it may be necessary to use .00005 mmf. in order to secure correct oscillation. No other special information is necessary as this crystal circuit performs in a satisfactory manner with low crystal current. The crystal oscillator tube used is the New Taylor T21 Beam Tube which is ideal for this work.

When using the transmitter on 5 meters best results will be obtained with a 20 meter crystal and 20 meter coil in the oscillator plate circuit. However, sufficient excitation can be had from a 40 meter crystal. When using a 40 meter crystal for 5 meter output a 20 meter oscillator plate coil is used and the oscillator becomes a harmonic oscillator. For 10 meter output either 40 or 20 meter
(Continued on Page 4)

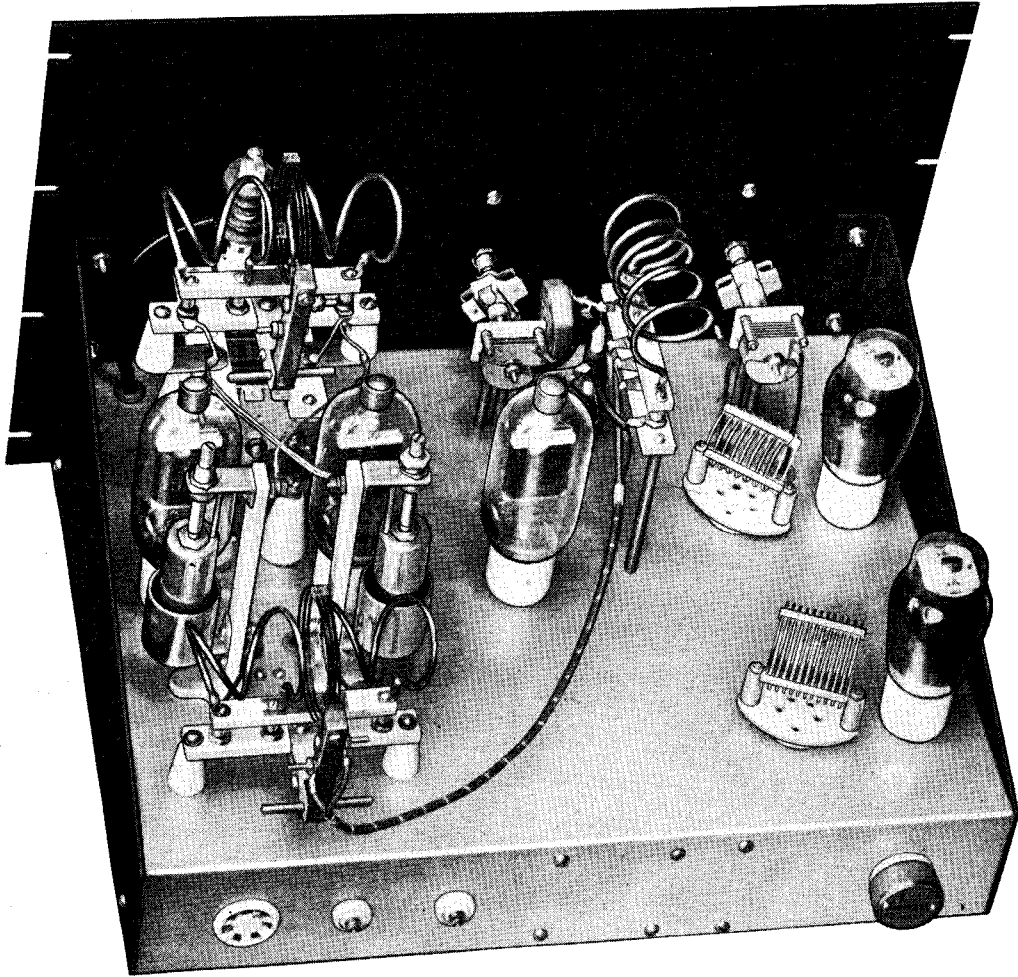

Top View—Unit No. 2—High Freq. R.F.

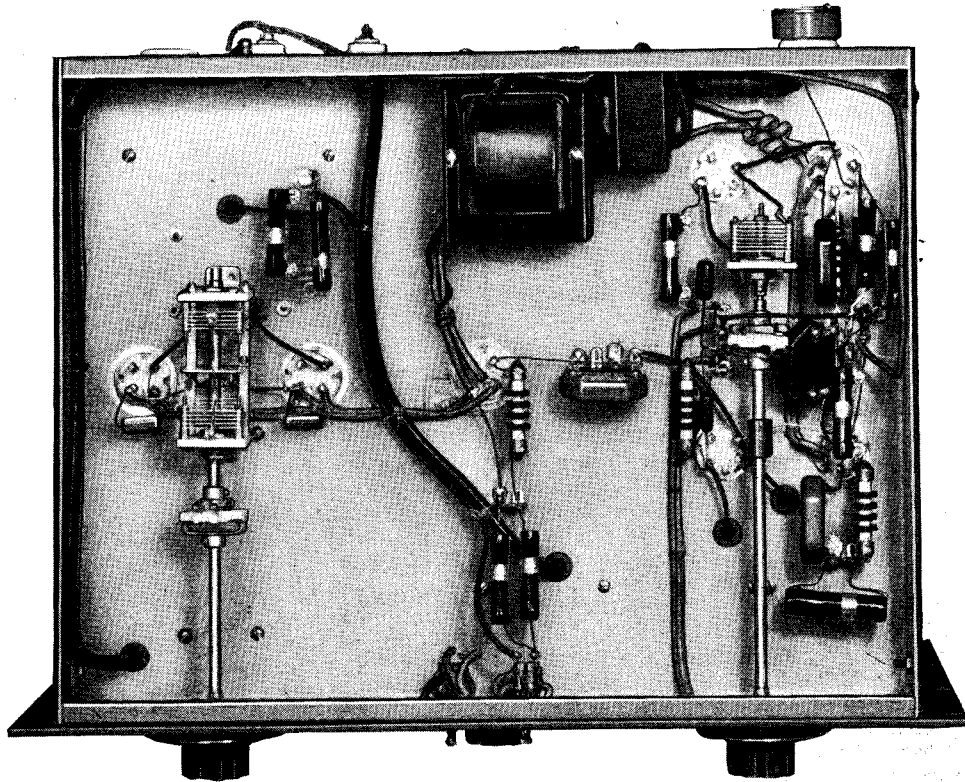

Bottom View—Unit No. 2—High Freq. R.F.

SPECIAL DATA—UNIT NO. 2

crystals are recommended, although an 80 meter crystal could be used. For 20 meter output a 40 meter crystal is recommended. However, an 80 meter crystal could be used. It is interesting to note that 5, 10 and 20 meter output can be had all from a 40 meter crystal. The oscillator is followed by a T21 Buffer-Doubler stage which can be operated on the same or twice the frequency of the oscillator, **but must be operated always at one-half the output frequency of the final stage.** Note that the cathode of both oscillator and the second T21 are both opened by keying. This is necessary to eliminate neutralization of the second T21 and no neutralization is necessary for stable operation as long as excitation is applied. The output of this stage is capacity coupled to a TZ40 **which must always operate as a doubler.** This eliminates the necessity of neutralizing this stage and lends toward perfect stability which is often difficult to obtain from a single ended neutralized stage at ultra high frequencies. The TZ40 is highly desirable in this stage due to its high amplification factor, 40 to 50% plate efficiency being easily obtained. This plate efficiency in doubling is certainly worthy of consideration to anyone that desires large amounts of driving power at high frequencies from a small grid input—and freedom from neutralization. Note that a very high value of grid leak, 25,000 ohms is used and under these conditions the normal rectified grid current should be 5 to 6 MA. This is equivalent to 10 to 12 times cut off bias. Up to this stage capacity coupling between stages has been used to eliminate all possible tuned circuits. The TZ40 doubler is link coupled to a B & W BVL unit in the grid circuit of the push pull TZ40 final amplifier. This provides a means of perfect regulation of the excitation to the final amplifier.

SPECIAL DATA—UNIT NO. 2

On preliminary test the final was found to contain a severe case of ultra high parasitic oscillation even though it was perfectly neutralized for the operating frequency. The trouble was due to the plate and grid leads, which are both very short and approximately the same length, falling in resonance and creating a push pull UHF oscillator. Under these conditions, the normal tank coils act as RF chokes to supply plate voltage and grid return to the TZ40's. This condition was cured by using nichrome wire of No. 22 gauge from the grid terminals on the sockets to the tuning condensers. These connections are referred to as Rx in the wiring diagram. The resistance has a negligible effect on the driving power required for the final and lends to perfect stability. Nichrome wire of approximately No. 22 gauge can be secured at Electrical Supply houses or can be removed from old rheostats or tapped filament resistors. Further evidence of the stability of the amplifier can be had from the fact that no fixed bias is used and no self oscillation is experienced when the excitation is removed and with the TZ40's drawing their normal resting current of 70 MA at 1250 V. One setting of neutralization will hold for both 10 and 20 meter operation and it is only necessary to increase the capacity of the Johnson N125 neutralizing condensers by approximately 2 turns of the lead screw for 5 meters. Preliminary neutralizing should be done by removing the 1250 V lead from the final amplifier and with the remainder of the transmitter operating adjust the N125 condensers until no dips occur in the grid current of the final which should read approximately 80 MA with no plate voltage. As a final check for perfect neutralization apply plate voltage to the final and place transmitter in operation. The final amplifier grid current will drop from 80 MA to approximately 60 MA with plate tank tuned to resonance and with antenna or dummy load connected. Note that the filament center tap of the TZ40 transformer is left ungrounded, with one side of each filament grounded and the opposite leg of each filament by-passed to ground. This was done to remove as much inductance as possible from the filament circuit to accomplish greater stability. The carrier is free of A. C. hum and no ill effects to the tubes can result from this connection. Two D. P. D. T. switches are provided to switch meter. One is connected in the grid circuit of the TZ40 doubler and push pull TZ40 final in order to measure either circuit with one meter. The other is used to select either oscillator current or first buffer doubler plate current. Note that two 400 volt lines have been provided, one being through the meter and the other un-metered. This is necessary in order to read true plate current on the T21's instead

of plate current plus bleeder and screen current.

The output from the final is taken from the swinging link of the B. & W. BVL unit providing perfect control of the amount of antenna coupling.

The Oscillator tuning condenser C-4 is mounted underneath the chassis approximately 8" from the panel. A 6" Johnson panel bearing, a brass 1/4" to 1/4" coupler and a Johnson flexible coupler type 250 are used to couple up with the dial. C-4 is mounted on a Trim-Air mounting bracket attached to two Cardwell BHP Hex. posts which are bolted to the chassis. First Buffer Doubler Condenser C-8 is mounted above the chassis—using a Trim-Air bracket attached to two Cardwell BMP mounting posts (reduced 3/8" in length). Condenser C-11 is mounted in exactly the same manner. The 2nd Doubler tank coil plugs into a B & W Jack strip type A-56 mounted on two FMP mounting pillars. The final amplifier grid tuning condenser C-12 beneath chassis is attached to the chassis thru use of two Trim-Air brackets. A 6" panel bearing and Johnson flexible coupler No. 250 connect the condenser to the Dial. The final amplifier tank condenser C-15 is mounted with terminals in up position, on 4-Johnson 1 1/2" Cone insulators on which have been mounted 4-Cardwell Standard mounting brackets. By following these instructions and dimensions all dials will appear in position shown in illustration. On top of C-15, the final amplifier tank coil—B & W BVL—is mounted thru use of two Johnson 1" Cones attached to two small brackets. 1 3/4" x 3/4" cut from 1/8" sheet aluminum. Feed-thru insulators used on rear of chassis are Johnson type 55. Dials used are Bud No. 713-2 3/4".

UNIT NO. 3—METER AND SWITCHING PANEL

This panel is located between the two RF chassis' and is provided with 4 millimeters of proper size for measuring plate and grid currents of either chassis'. This 5 1/4" panel is also provided with one D.P.S.T. toggle switch, connected for parallel operation to increase current carrying capacity, for lighting filaments and meter light. A S.P.S.T. toggle switch is used to operate the plate on and off relay which is a Guardian No. R100 110 A.C. operated. A third toggle switch, D.P.D.T. is used for band switching. A thorough understanding of the switching system used here is necessary for anyone constructing a rig like this as we believe this is the first Amateur transmitter kit to use such a system. Note that both RF sections are alike as far as operating voltages are concerned so that one set of power supply, modulator and meter are used. Plate voltage is connected to both chassis through the meters so both chassis would normally operate if it were not for provision being made to not have more than one chassis supplied with filament voltage at one time. One side of the D.P.D.T. switch is used to complete the primary circuit of the TZ40 filament transformers so that in one position the high frequency RF section filaments are lighted and in the other position the low frequency RF section filaments are lighted. Since instantaneous band switching was desired it was not possible to handle the T21 tubes in the same manner as they have indirectly heated cathodes. The T21's in both units are lighted at all times and the cathode circuit is selected by the other side of the D.P.D.T. switch. The center of the cathode side of the band change switch becomes one side of the key connection and the other side of the key is grounded.

The rear panel is Bud No. 139 mounted on four Bud No. 138 spacer rods. The relay is mounted on the rear panel with a Cardwell AMP mounting pillar and the filament transformer with two AMP's.

The Ohmite 75 watt 5,000 ohm resistor R-19 is mounted to the rear by means of their regular bracket and at the front end by means of their bracket and a piece of 1/8" sheet aluminum 2 3/8" by 3/8" which is fastened across the two spacer rods. Johnson type 55 feed-thru insulators are used and the sockets are Amphenol Steatite as they are thruout the entire Rig. Wiring is laced to the spacer rods adding much to the appearance. All high Voltage leads are type 7MM high tension cable. Lenz Dulac Wire was used in all the other cabling. This wire is available in many colors so that a color coding system can be followed.

UNIT NO. 4—LOW FREQUENCY R. F. CHASSIS

The R. F. section designed to operate on 20, 40, 80 and 160 meters is mounted on the same size chassis and panel as the R. F. sections and the same front layout was maintained for good

(Continued on Page 28)

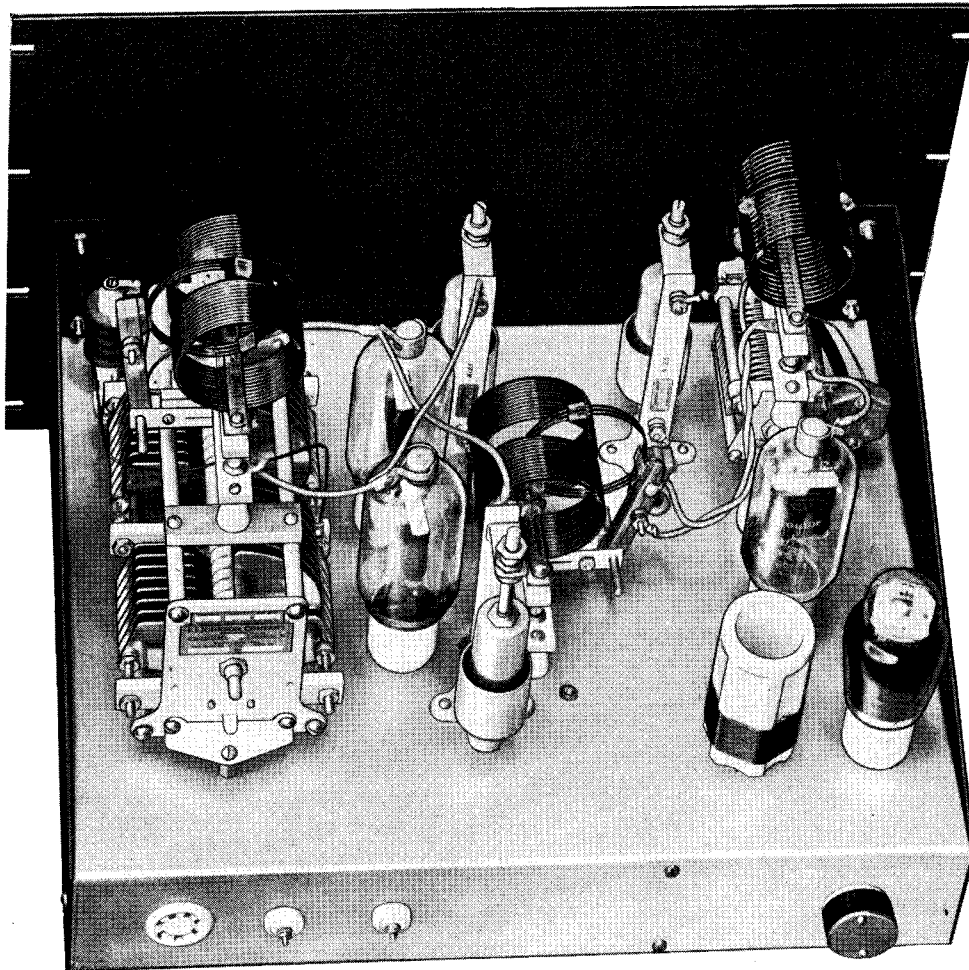

Top View—Unit No. 4—Low Freq. R.F.

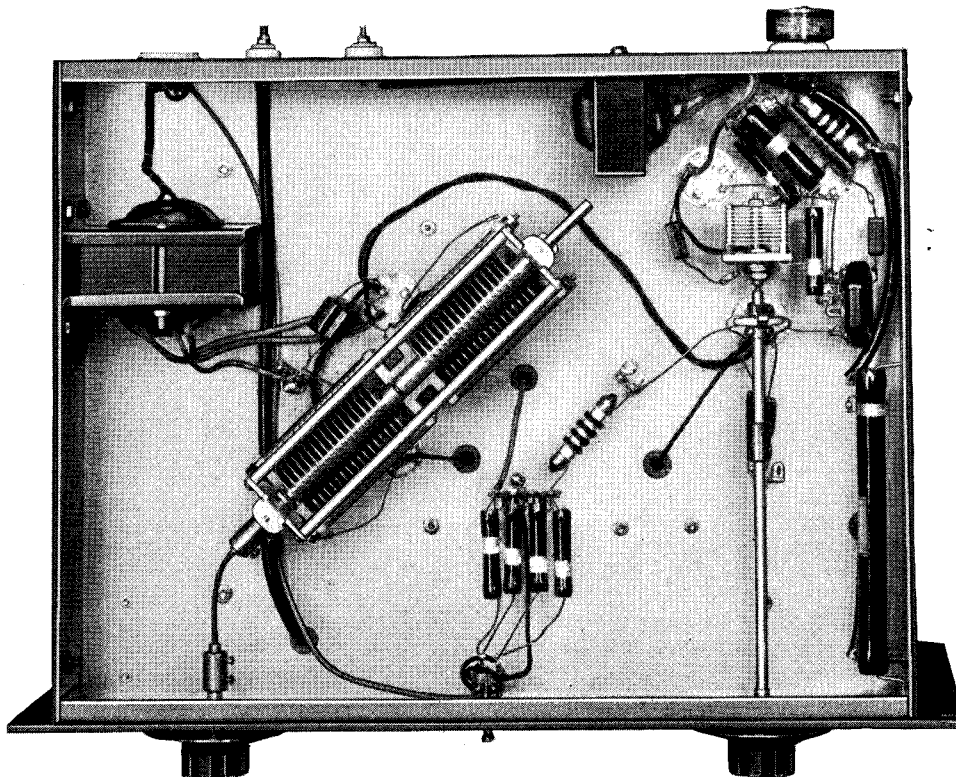

Bottom View—Unit No. 4—Low Freq. R.F.

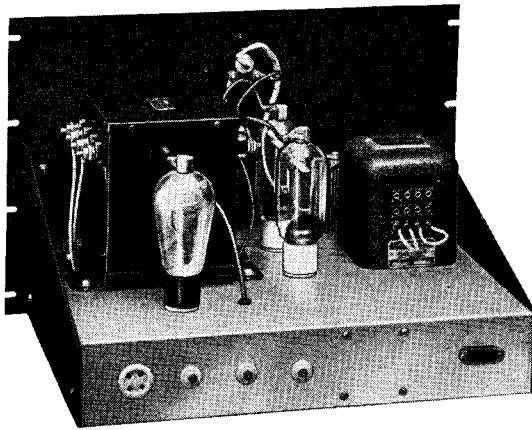

Unit No. 5—Modulator

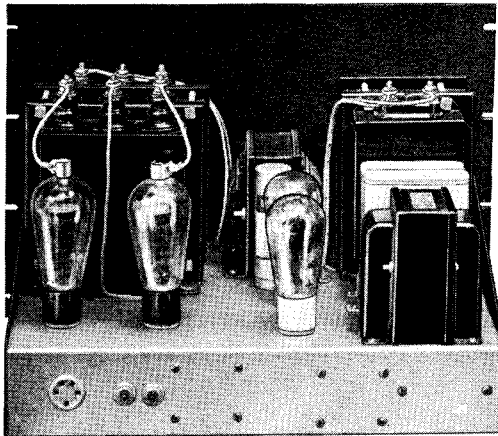

Unit No. 6—Power Supply

PARTS LIST

- T1 —6.3V 3A T-19F97*; S-P5014; G-1052; U-2296.
 T2 —7.5V 8A T-19F94*; S-P6138.
 T3-T4—same as T1. T5-T6—same as T2.
 T7 —2.5V 10A T-19F90*; S-P3025; U-1819.
 T8 —Input Transformer T-15D82*; S-A4704; U-8132.
 T9 —Modulation Transformer T-14M49*; S-A3829; U-8669.
 T10—Plate Transformer 1250V 500 MA. T-19P63*; S-P6153; U-1809.
 T11—Same as T7.
 T12—2.5V 5.25A T-19F88*; S-P6140; G-1416; U-2425.
 T13—Plate Transformer 400 V 250 MA T-19P55*; S-P3010; U-1800.
 Ch 1—8H. 200 MA choke T-13C30*; S-C1411; G-2158; U-4510.
 Ch 2—5—20H 500 MA choke T-19C38*; S-C1405; G-2160; U-4505.
 Ch 3—12H 300 MA choke T-19C43*; S-C1413; G-2156; U-1800.
 M1—5 amp. RF ammeter Triplett Type 346.
 M2—150 MA Triplett Type 326 or 227.
 M3—100 MA Triplett Type 326 or 227.
 M4—200 MA Triplett Type 326 or 227.
 M5—500 MA Triplett Type 326 or 227.
 M6—500 MA Triplett Type 326 or 227.
 SW1, SW2, SW4, SW6—DPDT Toggle Switch—Bud.
 SW3—DPST Toggle Switch—Bud.
 SW5—SPST Toggle Switch—Bud.
 SW7—Guardian SPST R-100 Relay.
 C4 —.000075—*C-ZU75AS; N-ST75; H-MC-75M.
 C8 —.000075—Same as C4.
 C11—.000025—*C-ZR25AS; J-25G20; N-SEU25; H-MC-20MX.
 C12—.00005 —*C-ER50AD; N-STD50; H-MC-50MX.
 C15—.000035—*C-NP35ND.
 C19—.0001 —CZU100AS; *J-100F20; N-ST100; H-MC-100M.
 C23—.00015—C-MT150GS; *J-150F20; N-TMC150; H-TC165K.
 C24—.0002 —*J-200FD20; H-TC210L.
 C29—.0002 —C-XE240KD; *J-200DD35.
 NC—Johnson NC-125.
 T = Thordarson S = Stancor G = General U = Utah
 C = Cardwell; J = Johnson; N = National; H = Hammarlund.
 * Indicates parts used and shown in photos.

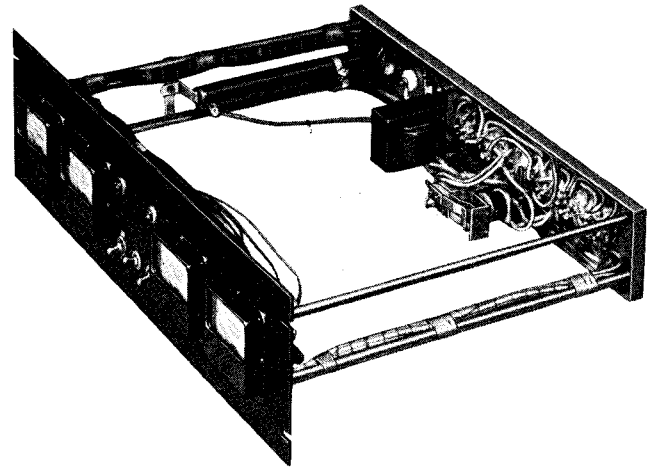

Unit No. 4—Meter Panel

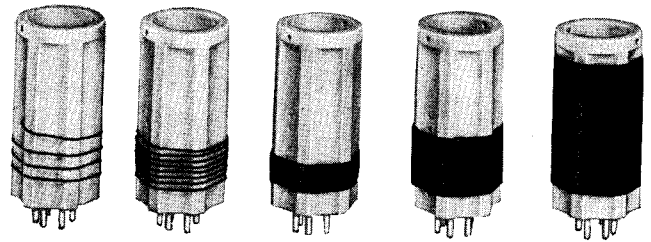

Coils

Band	L ₁	L ₂	L ₃
160 Meters	56 turns No. 16 1 3/4" dia. close wound	Same as L ₁	Same as L ₁
80 Meters	25 turns No. 16 1 3/4" dia. close wound	Same as L ₁	Same as L ₁
40 Meters	12 turns No. 16 1 3/4" dia. close wound	Same as L ₁	Same as L ₁
20 Meters	7 turns No. 16 1" long 1 3/4" dia.	Same as L ₁	Same as L ₁
10 Meters	3 1/2 turns No. 16 1" long 1 3/4" dia.	Same as L ₁	Same as L ₁

L₃ and L₄ = B & W type BL coil with end link.
 L₅, L₈, L₁₂ and L₁₅ = B & W type BVL swinging link assembly.
 L₆, L₇, L₁₃ and L₁₄ = B & W BVL coils. (See text.)
 L₁₀ and L₁₁ = B & W type BL coil with center link.

See Text on Coils, Page 28.

- R1, 13—50,000 ohm 1 watt IRC
 R2, 3, 6, 15, 16, 17—10,000 ohm 10 watt Ohmite* or IRC
 R4 — 5,000 ohm 10 watt Ohmite or IRC
 R5 — 50,000 ohm 10 watt Ohmite or IRC
 R7 — 25,000 ohm 10 watt Ohmite or IRC
 R8, 9, 12, 18, 20, 21—1,000 ohm 10 watt Ohmite or IRC
 R10— 750 ohm 10 watt Ohmite or IRC
 R11— 5,000 ohm 100 watt Ohmite or IRC
 R14— 200 ohm 10 watt Ohmite or IRC
 R19— 5,000 ohm 75 watt Ohmite or IRC
 R22— 100 ohm 10 watt Ohmite or IRC
 R23—100,000 ohm 100 watt Ohmite or IRC
 Rx —See "Special data" Unit No. 2
 C1, 30—.001 mica 2500V Cornell-Dubilier
 C2, 3, 6, 7, 9, 13, 14, 16, 17, 18, 21, 22, 25, 26, 27, 28—.006 mica 600V C-D
 C5, 20—.00005 mica 2500V C-D
 C10-C34—.002 mica 2500V C-D
 C31—8 mfd 450V electrolytic C-D
 C32, C33—4 mfd 1500V C-D
 RFC —R100's National
 RFC-1—R154's National

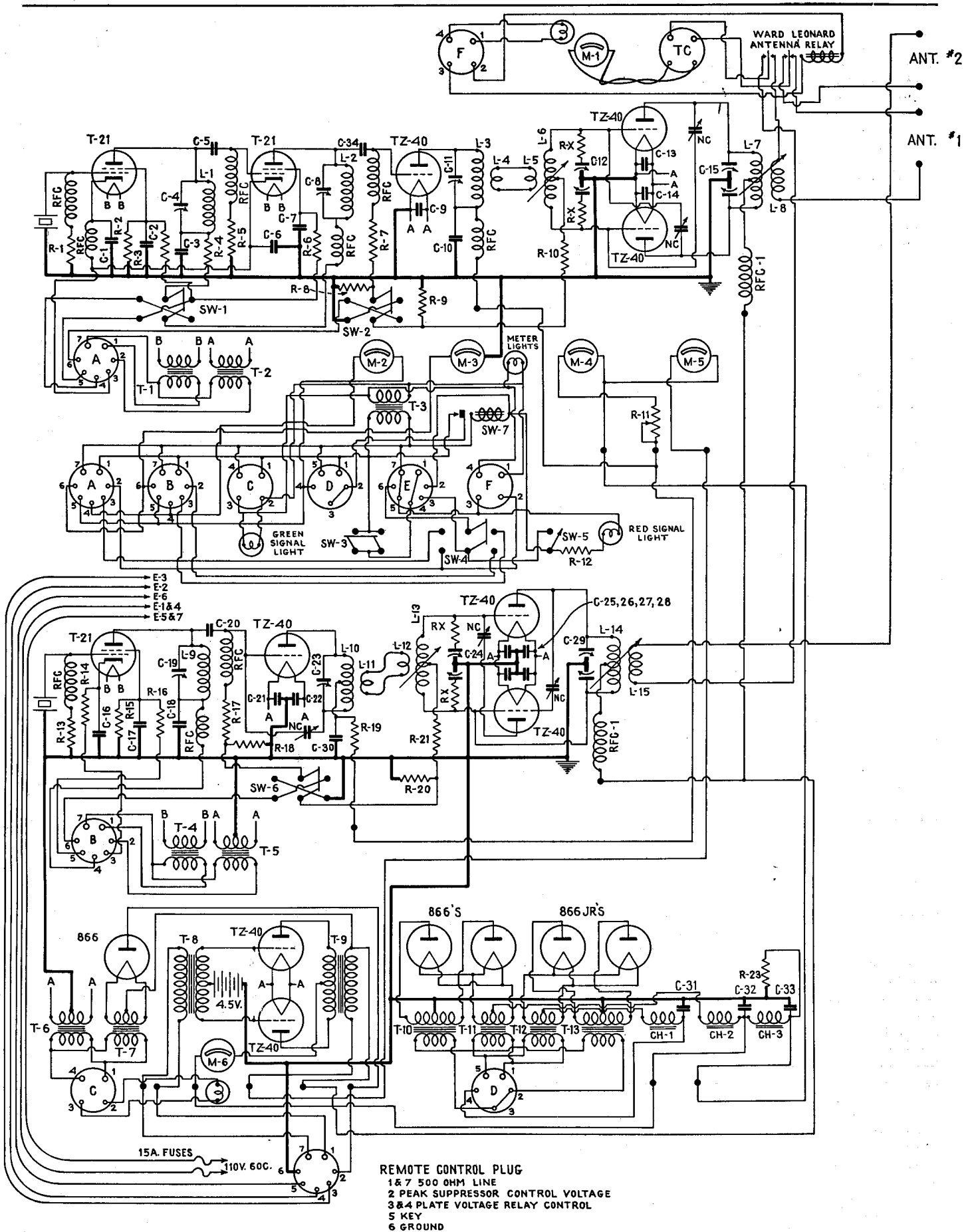

Fig. 1

Errata: Add a by-pass condenser, same as C-3, from bottom of L-2 to ground.

UNIT 4—CONT.

appearance. The layout is essentially the same as the high frequency chassis except that only one T21 is used and that tank condensers of proper size for the lower frequencies were used. The T21 oscillator as shown is a straight pentode oscillator and can be converted to a regenerative type if desired by adding a R100 choke and .0001 condenser. In most cases, we believe this is not necessary as the TZ40 following can be used as a doubler or fundamental amplifier and furnish ample excitation for the PP TZ40 final. It was found advisable to add an additional 5000 ohm series resistor to the first TZ40 of this unit in order to reduce the available excitation to a more reasonable limit, as the efficiency of this stage is considerably higher than the corresponding stage in the other chassis due to lower operating frequencies. A single section condenser with RF ground on center of the plate coil of this stage was used to effect plate neutralization. This permits using an RF choke in the grid circuit with capacity coupling and the elimination of a choke in the plate circuit alleviating any chance of low frequency parasitics. The final amplifier is a conventional PP amplifier except the same precautions were taken to eliminate ultra high frequency parasitics as were used in the other chassis. B & W BVL units were used in both grid and plate circuits in order to have complete control over excitation and antenna coupling. It will be noticed that it is possible to operate either RF section on the 20 meter band. This is easily accomplished with proper L/C ratios by the proper selection of parts. This feature should be very popular with those Amateurs who prefer to operate exclusively in the high and ultra high frequencies as this unit which we refer to as the low frequency unit can be left on 20 meters and the high frequency unit then can be ready for instant use on either 5 or 10 meters.

Condenser C-19 is the same as C-4 in Unit No. 2. Condenser C-23 is mounted on two Johnson 1½" Cones. Buffer-Doubler tank coil is mounted on top of C-23 by means of ½" Cones which are fastened to the condenser with the angles that come with Johnson condensers. Final amplifier grid tuning condenser C-24 is mounted in at an angle in order to give short grid leads. It is attached to the chassis thru use of the regular Johnson condenser brackets and stood off on the spacers that ordinarily are used to hold the condenser on a panel. Tuning is accomplished thru use of a panel bearing—3" flexible shaft and two ¼" to ¼" shaft couplings. Coil L-13, a B & W BVL unit has the jack bar mounted on two ½" Cones. Condenser C-29 is mounted on two Johnson panel spacers that come with the unit. The shaft is connected to the dial thru use of a Johnson ¼" to ¼" No. 252 coupler and 1½" of ¼" shaft. Coil L-14 is mounted on top of C-29 by means of two 2½" x ¾" x ⅜" aluminum bars. Holes are drilled thru these bars and thru the condenser tie rods. Tie rod holes are tapped 6/32. All wires that go thru the top of the chassis are carried thru ⅜" rubber grommets—these holes are already drilled in the chassis.

UNIT NO. 5 CLASS B MODULATOR

This unit uses two type TZ40 tubes in conjunction with a Thordarson T-15D82 Multi match 500 ohm line to grid transformer and a Thordarson T-14M49 modulation transformer. Since the TZ40's are operating at 1250 volts off the common plate supply there is available approximately 225 watts of audio which would over modulate the normal 275 watt unput if the grids are driven too extreme. It was found necessary to operate the input transformer at a ratio of 1 to .75 to properly regulate the drive. A 4.5 VC battery is necessary to limit the resting current when using 1250V on the plates, the normal current under this condition being approximately 30Ma. This chassis also contains a single 866 rectifier and filament transformer. This tube is used as a rectifier to operate the peak limiting circuit in the Thordarson amplifier. Full details as to the theory of operation can be found in the October, 1937, issue of QST Page 31. The 500 ohm line input and the peak limiting bias line are brought into the chassis by means of an Amphenol type S3S socket and 70-3S plug. The secondary of the Class B should be operated on the 4500 ohm connection. The 500 ohm line should connect to the A terminals of the multi match input transformer. The G terminals on the jack panel of the transformer should be connected to the .75 connection. Complete modulation with sine wave input is accomplished with an average plate current of approximately 180 MA and with voice input approximately 110 MA.

The peak limiting circuit used with this transmitter automatically limits the plate current to the above values even if the gain control is turned full on. These parts are mounted on a 17X13X3 chassis and a 12¼" steel front panel.

UNIT NO. 6 POWER SUPPLY

The entire transmitter is operated from one 1000 to 1250 Volt 500 MA power supply and one 400 Volt 150 MA power supply. Both units are mounted on one 3x17x13 chassis. The voltage for the Class B modulator is taken off after the T-19C38 500 MA swinging choke and the Class C voltage is further filtered by a smoothing choke (T-19C43) and condenser. This constitutes a saving in space and money in that only a 300 MA smoothing choke is required and the Class C voltage regulation is improved. No hum can be detected on any frequency even with the Class C input 50% above normal. A 100,000 ohm 100 watt Ohmite bleeder resistor is used on the high voltage power supply.

PERFORMANCE

This transmitter has been designed for a normal input of 275 watts equivalent to 220 MA final amplifier plate current when using 1250 volts on the plate. In actual operation this was easily accomplished on all bands including 5 meters. Measured power output gave an indicated plate efficiency of 65% on 5 meters and 70% or better on all other bands. At these percentages of efficiencies no color will show on the anodes. Taylor carbon anodes in the T-40 and TZ-40 type tubes show color at 60 watts plate dissipation and if color is noted it is obvious that efficiency is low. By comparing meter reading and adjusting your circuit to conform to the meter readings listed below it is next to an impossibility to obtain anything but a high percentage of efficiency. A typical set of meter readings are listed below which hold for all frequencies.

HIGH FREQUENCY UNIT

Osc. Pl.	1st doubler pl.	2nd doubler grid.	2nd doubler pl.
30 MA	40-60 MA	5-6 MA	60-80
	Final Amp. grid		Final Amp. Pl.
	50 MA		220

LOW FREQUENCY UNIT

Osc. Pl.	Double Buffer Pl.	Final Amp. grid	Final Amp. Pl.
30 MA	50 MA	50 MA	220 MA

If the low frequency is built with the intention of 160 meter telephone operation, it will be necessary to reduce the plate voltage to 1000 volts, which is easily accomplished by changing the primary connection to the plate transformer. This is due to the fact that the 200 DD 35 does not have quite sufficient spacing for 1250 volt fone operation. Condensers of sufficient spacing and capacity for 160 meter telephone operation with 1250 volts are generally too large to mount on a 13 inch chassis. By eliminating 160 meters from the low frequency unit, a Johnson type 100 DD 70 can be substituted C-29. This condenser will permit 1250 volt operation as low as approximately 3600KC. The two condensers are approximately the same size and price. There is still one possibility that should work but has not been tried, which is to insulate the condenser from ground and by pass it to ground with a .001 2500 volt condenser. This will allow a connection to be made from the positive high voltage supply to the RF choke and the frame of the condenser. This will increase the flash over voltage of the condenser considerably. Further details on this arrangement can be found in December 1938 QST, page 37. If this method is used, great care should be used in the selection of the tuning dial as it must be able to insulate the operator from 2500 volts.

COILS

All plate coils for the T-21 stages of both RF sections plug into 5-prong Amphenol Steatite sockets. All these coils are identical for a given frequency. Coils may be wound on Johnson 647 5-prong coil forms from data given in Fig. No. 2 or if it is desired to use manufactured coils, Decker low power coils without link or center taps can be used. These coils are designed for link coupling and as these units use capacity coupling it is necessary to tap the Decker coil, removing sufficient inductance to compensate for the added capacity.

All coils used in the TZ-40 grid and plate circuits are Barker & Williamson. This we believe is far better than making improvised coils, and proper L/C ratio is insured. Each final amplifier uses two 2 BVL units, one in the grid circuit and the other in the plate, in order to have perfect regulation of grid drive and antenna coupling.

For 160 meter operation of the low frequency unit, special Barker-Williamson type BVL coils are necessary. These coils are known as Taylor Tyle 160BVL, and may be had at your jobber.

The TZ-40 doubler stage in the High Frequency unit uses B & W type BL coils with end link which mounts in a B & W type A56 Jack bar. The TZ-40 doubler or buffer stage in the low frequency unit uses B & W type BL center linked coils which mount in a type A56 Jack bar.

When setting up the high frequency unit on 5 meters it is necessary to spread the turn on the 5 BL and 5 BVL coils until the coils occupy slightly more than the length of the insulating bar as can be seen in the photograph of the high frequency unit. It is also necessary to connect the two inner banana type plugs on the 5 BVL coils together with a strip of sheet copper in order to remove the inductance normally contributed by the banana jacks and jumper across the jacks. When this is done, resonance in the middle of the 5 meter band will occur at approximately 10 degrees on both grid and plate tuning condenser of the final amplifier and at approximately 25 degrees on the TZ-40 double tuning condenser.

Taylor Tubes

QBC

Quick Band-Change

(125 Watts Input)

TRANSMITTER

Features:

- Front of Panel Control
Of all adjustments on
- Three Bands
Without changing coils
- 8 Crystals Mounted
Using Kelvin Holder
- Ideal As Exciter
For Finals with up to 800-900 watts
Input
- High Efficiency Circuit
- Low Parts Cost

TAYLOR Q. B. C. TRANSMITTER QUICK BAND CHANGE—10 TO 160 METERS

This transmitter was designed with the idea of showing the simplest possible way to obtain "front of panel" band switching in a 125 watt telegraph transmitter. The use of one common power supply for both oscillator and final amplifier was tried and found to be entirely satisfactory for telegraph service. A simple band switching arrangement was applied to a Tri-Tet oscillator which gives good output from 160 meters to 20 meters. 10 meter operation is accomplished by doubling in the TZ-40 with 100 watts input.

Further flexibility of frequency changing was obtained by using a Kelvin multiple crystal holder which will mount up to 8 unmounted crystals. A Kelvin multiple crystal holder can also be had that will mount 6 mounted crystals that normally plug into a 5-prong tube socket.

The most important piece of apparatus necessary for band switching is the Barker & Williamson Model "B" Turret which enables the selection of three plate tank coils from the front of the panel.

The Taylor T-21 Beam power tube was selected as the proper oscillator tube due to the high power output obtainable. The TZ-40 was selected as the proper output tube due to its low driving requirements and that no bias is necessary to limit the plate current to a safe limit with no excitation. Operating bias is obtained from a grid leak. The transmitter is housed in a Bud No. 697 26½" steel cabinet and when assembled as shown weighs approximately 120 pounds which makes it desirable as a portable transmitter for emergencies, etc.

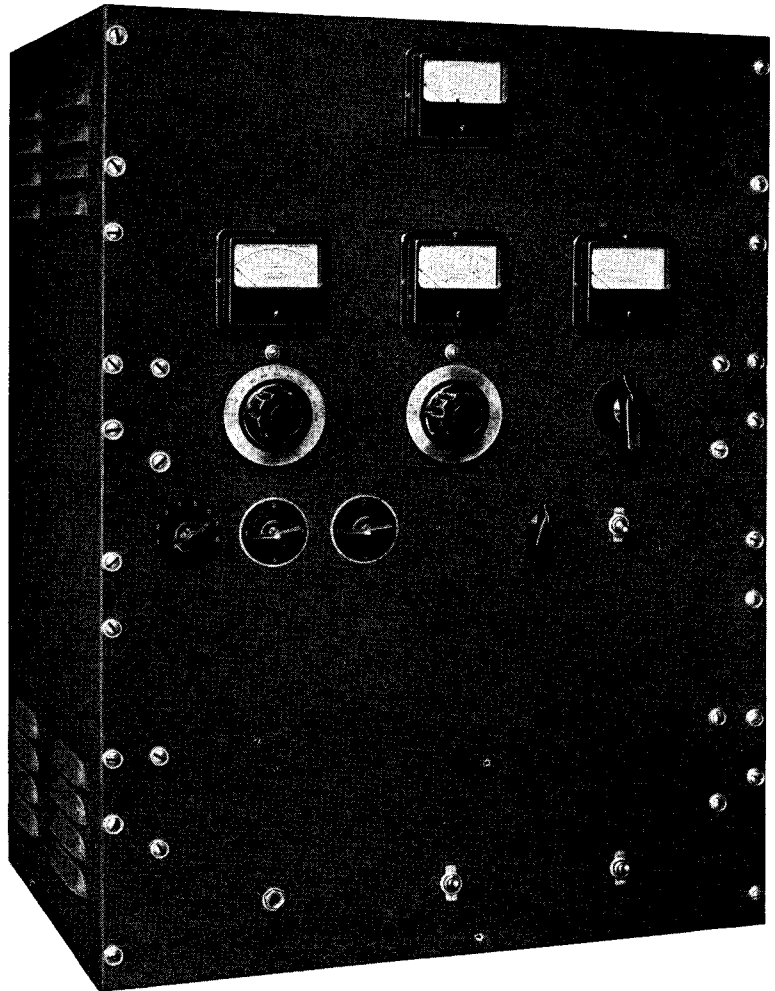

CONSTRUCTIONAL DATA

UNIT NO. 1

This unit consists of a 5¼" Bud 1590 Masonite panel and mounts only the Triplet 227 0-2.5 RF ammeter. The remaining panel space was intended for antenna tuning and switching arrangements. Since so many different systems can be used and requirements for various stations differ, this part has been left to the individual amateur. Some suggested basis circuits of antenna coupling circuits are shown in Fig. 2.

For operation with half wave doublets it will be found that the fixed coupling on the BL coils is too great, resulting in overloading of the final amp. The coupling can be reduced to the proper value by connecting a fixed or Variable condenser in series with the transmission line. Values from .00005 to .00025 will fit most cases. When this system is used the transmission line should retain its untuned line characteristics and present the proper load to the final amplifier, provided the line does not happen to fall in resonance with the output frequency just as optimum coupling is reached.

UNIT NO. 2

This unit is mounted on a 13 x 17 x 3 Bud chassis and a Bud 10½" Masonite Panel. The Kelvin Multiple crystal holder is mounted vertically on the rear of the chassis and is actuated from the front of the panel by means of a 6" Johnson panel bearing and a 6" Johnson flexible shaft to make the 90 degree bend. It was found necessary to enclose the flexible shaft in ¼" copper tubing to remove back lash from the shaft when driving the switch in the crystal holder due to the strength of the spring in the

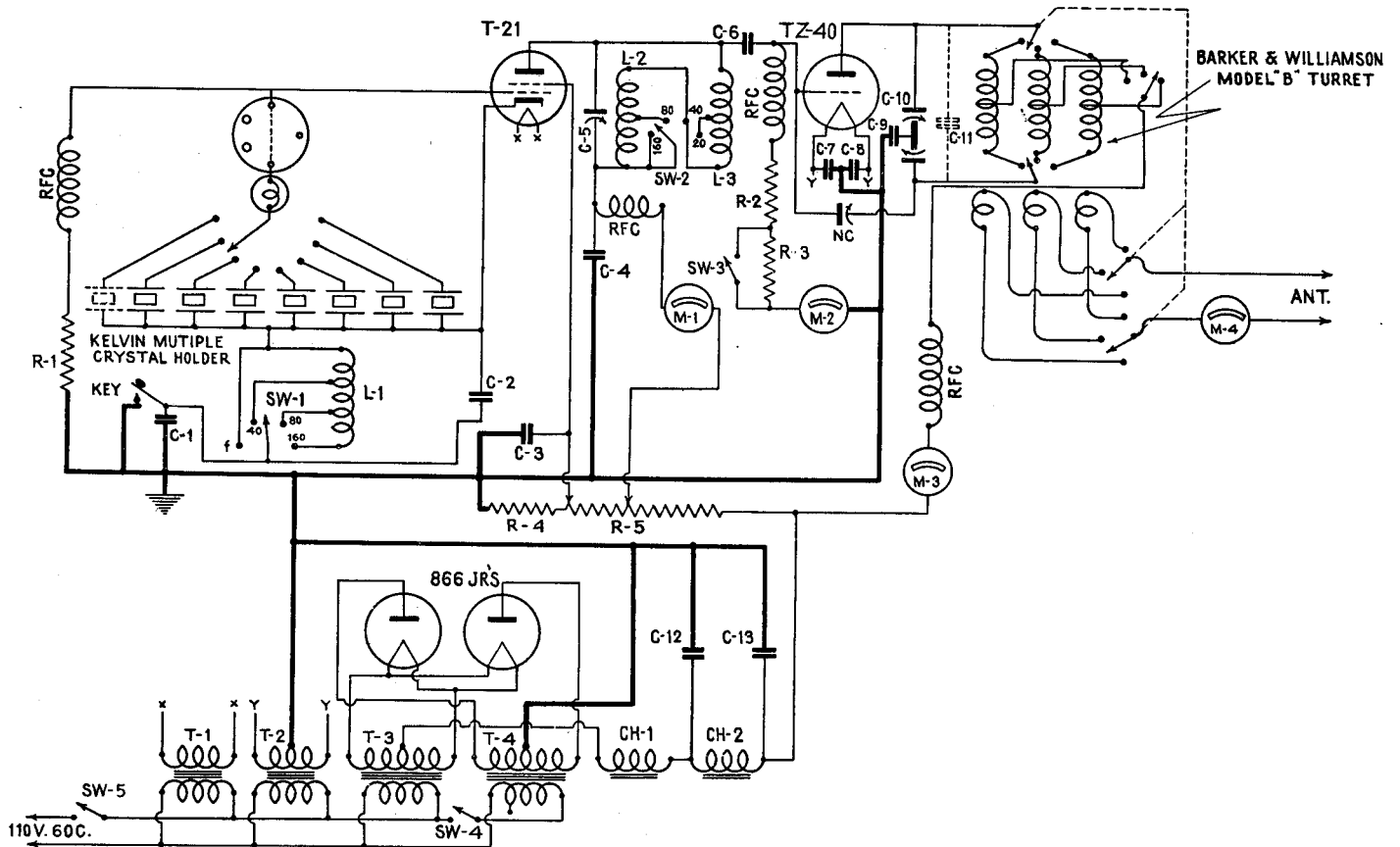
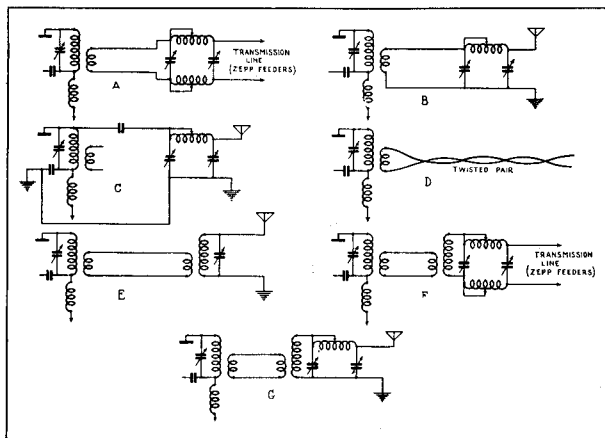

Fig. 1

Parts List

- R1—100,000 ohm 1 watt IRC
- R2— 5,000 ohm 10 watt Ohmite
- R3— 20,000 ohm 10 watt Ohmite
- R4— 5,000 ohm 100 watt Ohmite
- R5— 15,000 ohm 200 watt Dividohm
- C1— .01 600V mica C-D
- C2— .0001 1200V mica C-D
- C3— .006 600V mica C-D
- C4— .006 600V mica C-D
- C5—MR105BS (Cardwell)
- C6—.00005 1200V C-D
- C7, C8—.006 600V mica C-D
- C9— .001 1200V C-D
- C10—Cardwell MT100GD
- C11—Cardwell JD-50-OS
- C12, C-13 2 MFD. 1500V. C-D TJU15020

- M1—Triplet 0-150 MA Type 227
- M2—Triplet 0-100 MA Type 227
- M3—Triplet 0-300 MA Type 227
- M4—Triplet 0-2.5 A RF Ammeter Type 247
- T1—Thordarson T-19F97
- T2—Thordarson T-19F93
- T3—Thordarson T-19F88
- T4—Thordarson T-19P59
- CH-1—Thordarson T-19C43
- CH-2—Thordarson T-19C36
- SW-1, SW-2—Centralab 4 point ceramic switch
- SW-3, 4, 5—SPST Toggle switch
- RFC—2.5 mh Hammarlund Type CHX



ANTENNA CHART

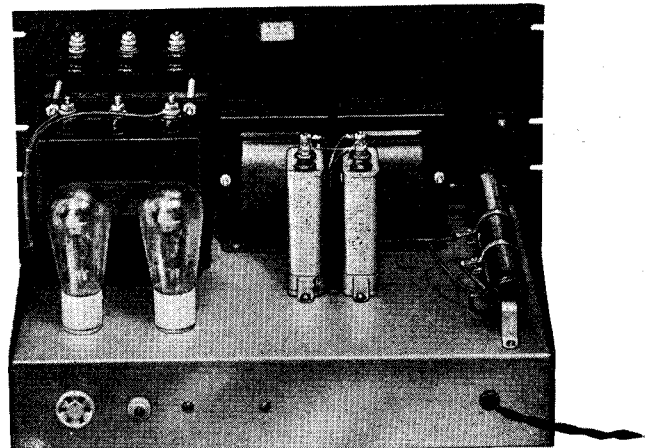

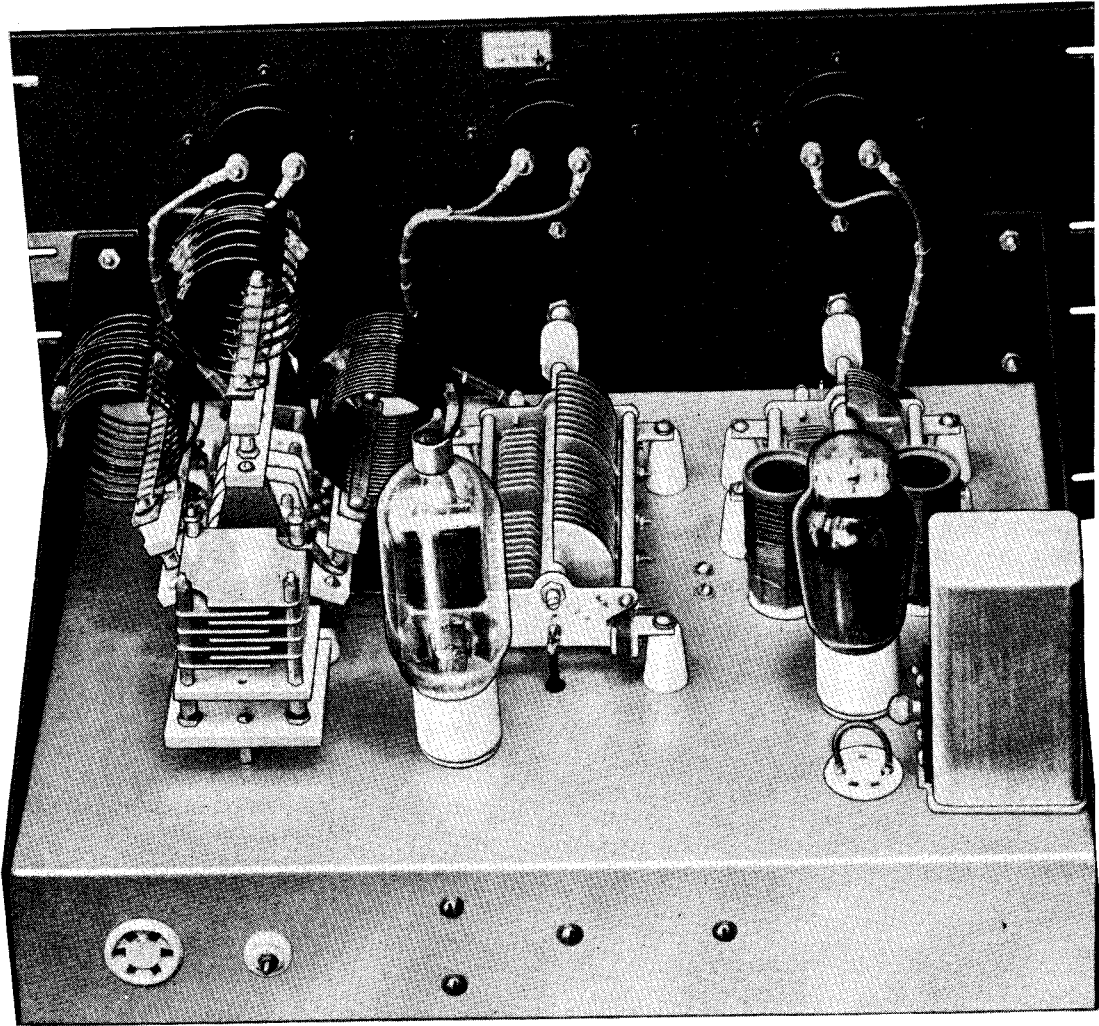

Top View—QBC Unit No. 1

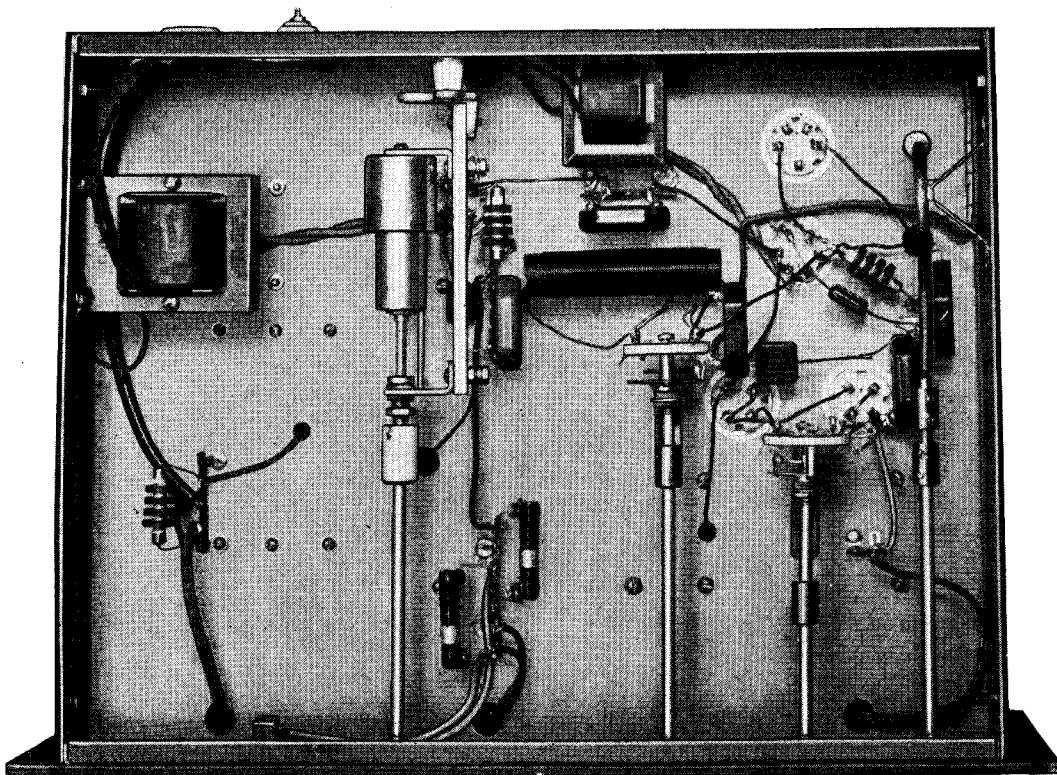

Bottom View—QBC Unit No. 1

COMPLETE CONSTRUCTIONAL DATA

switch. A 5-prong Amphenol Steatite socket has been provided beside the multiple crystal holder and connected in series in order that a mounted crystal can be used if desired. Normally this socket is shorted out with a small jumper. When using a mounted crystal the multiple holder is shorted out by removing the crystal from No. 1 position and turning the selector switch to No. 1 position. This procedure allows the miniature lamp crystal fuse in the Kelvin holder to serve for any crystal.

As will be noted in the diagram the cathode coil of the Tri-Tet oscillator employs a fixed condenser and a tapped coil. (L_1) The taps are selected with a Centralab 4-point ceramic switch, one point being used for connecting the cathode of the T-21 direct to the key lead for fundamental operation. The other three taps are used for harmonic operation of 40, 80, or 160 meter crystals. The cathode coil (L_1) is one continuous coil $\frac{3}{4}$ " dia. and $3\frac{1}{2}$ inches long close wound on a Bakelite form with 70 turns of No. 18 enameled wire. The entire coil is used when using 160 meter crystals. A tap is taken off at 15 turns for 80 meter crystals and a tap at 8 turns for 40 meter crystals. A .0001 Cornell-Doublier 1200 V mica condenser is used as a fixed cathode condenser. This circuit is not critical in tuning and no difficulty should be encountered due to small variations of this condenser due to manufacturing tolerances.

The plate inductances for the T-21 (L_2, L_3) are wound on 2 $1\frac{1}{4}$ " D x $2\frac{1}{8}$ " 4-prong coil forms. Actually the coil is one continuous coil tapped for 20, 40, 80 and 160 meters. The 20-meter coil consists of 8 T No. 16 $1\frac{1}{4}$ " D and spaced to occupy $\frac{3}{4}$ inch. The 40-meter coil is the 20-meter coil plus 10 T No. 18 close wound on the same form. The 80 meter coil is a continuation of the first two coils but on another form and consists of 19 turns No. 18 close wound $1\frac{1}{4}$ " D. An additional 40 Turns of No. 22 wire is close wound on the same form to complete the plate inductance for 160-meter operation.

The Cardwell MR105BS oscillator tuning condenser is mounted above the chassis and approximately 2" behind the panel. Insulation is provided by 1" Johnson cone insulators used to mount the condenser. Rubber grommets are used to provide insulation for wires that go through the chassis.

The T-21 oscillator stage is capacity coupled to the TZ-40 final amplifier. When operating as a straight amplifier a 5000 ohm grid lead is used. An additional grid leak of 20000 ohms is also connected in the circuit but normally shorted out by SW 3. The additional resistance is used when the TZ-40 is used as a doubler. Neutralization is accomplished with a Johnson N-125 condenser mounted horizontally underneath the chassis. Two 1" Johnson cone insulators are used under the mounting foot of the N-125 and adjustment is made by means of a 6" Johnson panel bearing and a Johnson No. 252 ceramic shaft coupling.

The final amplifier tuning condenser, (C10) Cardwell MT100GD, is mounted on 1" Johnson cone insulators approximately 2" behind the panel and in the center of the chassis. The B & W Turret is mounted approximately 2" from panel and on the right end of the chassis. Johnson $\frac{1}{2}$ " cone insulators are used to stand the Turret off from the chassis. Immediately to the rear of the Turret is mounted a Cardwell JB base. When operating on 80 and 160 meters a Cardwell JD-50-OS fixed air condenser is plugged into the JB base to furnish the additional capacity necessary to effect resonance on these bands.

Filament transformers for the transmitters are mounted under the chassis and 110 AC is brought into the chassis through a 6-prong Amphenol socket and plug. This plug also carries the oscillator screen and plate voltage, keying circuit and ground. Plate voltage for the TZ-40 is brought into the chassis through a Johnson No. 55 lead-in bushing.

UNIT NO. 3—POWER SUPPLY

The power supply is mounted on a 13" x 17" x 3" Bud chassis and a 10 $\frac{1}{2}$ " Bud masonite panel. A 1000 V 300 MA transformer is used along with a pair of Taylor 866 Jrs. to furnish all plate voltage. A two section filter is used. Filter condensers used are two Cornell Dubilier 2 Mfd. 1500 V. This insures absolute freedom from hum when using the one supply for oscillator and amplifier.

Oscillator plate and screen voltages are taken from a voltage divider connected across the output of the power pack. The voltage divider consists of an Ohmite 5000 ohm 100 watt resistor mounted under the chassis connected to the negative high voltage. An Ohmite 15000 ohm resistor is mounted above the chassis and is connected from the 5000 ohm resistor to positive 1000 V. Two adjustable sliders are used on the 15,000 ohm "Dividohm" to take off screen and plate voltage for the T-21 oscillator. The screen voltage should be adjusted to 150-200 volts under load and the plate voltage should be set at 400 volts under load. If no voltmeter is available, a close approximation can be made by referring to the photograph of this unit. A jack is provided for the key connection and is mounted in the chassis along with the two power switches.

OPERATION

Operation of this transmitter is conventional in every respect. When making adjustments to the oscillator be sure that the cathode switch is in the fundamental operation position when fundamental output from the crystal is desired, otherwise a crystal may be damaged. In most cases when using harmonic operation, double crystal frequency output will be required. However, with active 160 and 80 meter crystals it is possible to obtain good output at four times crystal frequency.

Neutralization of the final amplifier is easily accomplished by removing the high voltage at the feed through insulator and adjusting neutralizing condenser until no dip is perceptible in the grid current as the plate circuit is tuned through resonance. The TZ-40 is normally operated as a straight through amplifier from 160 to 20 meters. However, it may be operated as a doubler with slightly reduced plate efficiency. Ten meter output is secured by using the TZ-40 as a doubler. The normal input as an amplifier is 125 watts with 90 watts output on all frequencies up to 14.4 mc. The recommended input on 10 meters or any other frequencies when doubling is 100 watts with an output of 50 watts or better.

This unit not only makes an excellent medium power telegraph transmitter but offers some interesting possibilities as a band switching exciter for a high powered final amplifier.

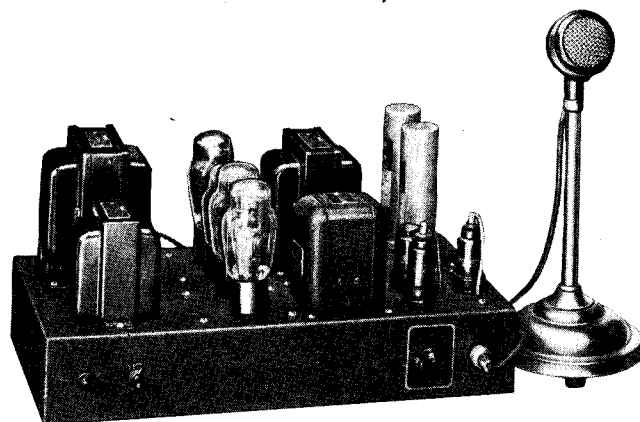

**SPEECH AMPLIFIER FOR DUAL UNIT RIG
With Peak Compression**

An illustration of the Thordarson Amateur Special Speech Amplifier incorporating the W2BRO system of Peak Compression Control. Similar units made by other manufacturers, and having same general specifications, can be used.

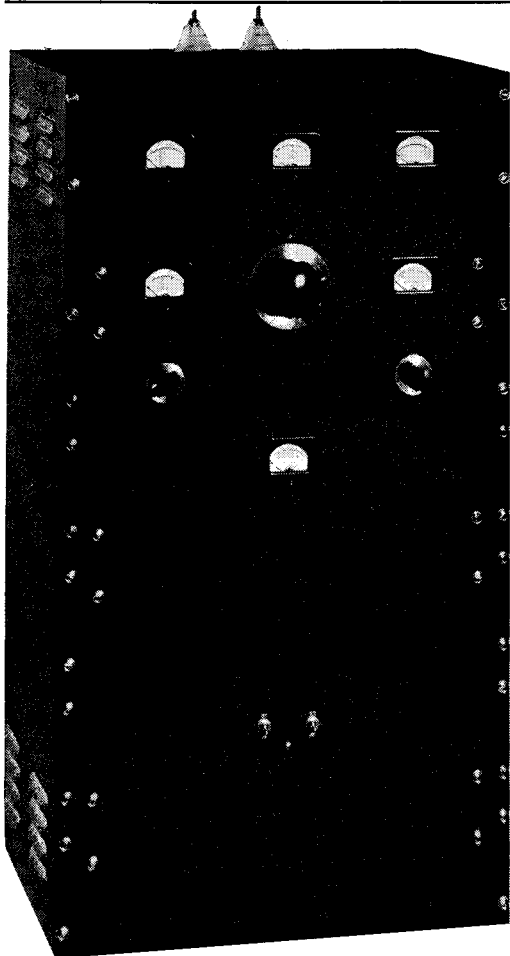

A TAYLOR TUBES-NATIONAL CO.

COMPLETE

450 WATT

PHONE AND CW TRANSMITTER

Featuring the

NTE EXCITER UNIT

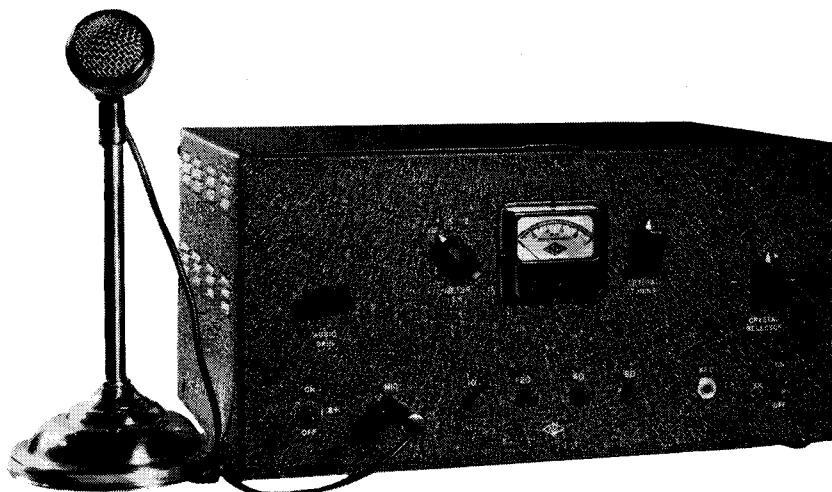

EFFICIENT --- COMPACT --- ECONOMICAL

HIGHLIGHTS

- Easy—rapid band change.
- Modern circuit design.
- Commercial appearance.
- Extremely compact.
- High quality apparatus used thruout.
- Ample excitation—both RF and Audio.
- Very easy to construct.
- Covers 3.5MC to 30MC.
- Low cost.

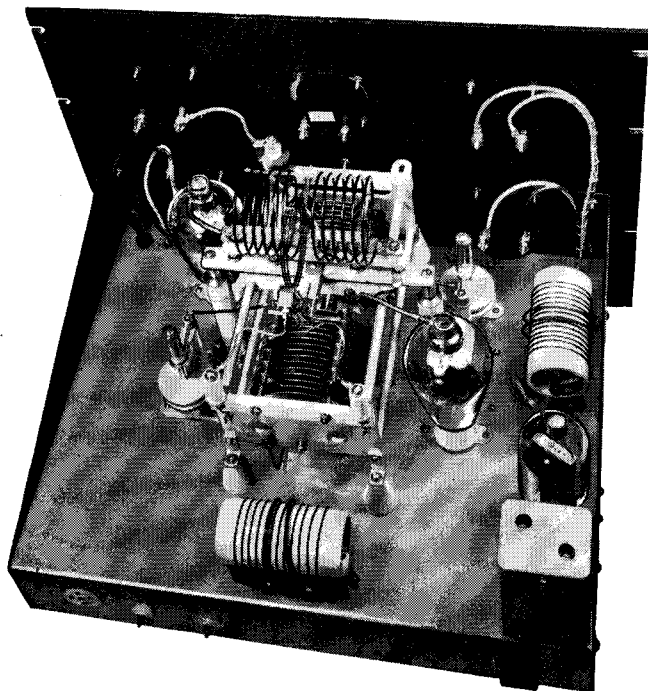

This suggested transmitter design is destined to be very popular due to its many modern features. While no drilled chassis or templates are available it will be found to be simple to build. If phone operation is not desired, the National Co. NTE-C Unit may be used and the Modulator Unit and one section of the

power supply may be omitted. For CW operation, the Meissner Signal Shifter could be used successfully. Your distributor carries all necessary parts in stock and will help you technically if you decide to build this Transmitter.

CONSTRUCTIONAL DATA FOR NATIONAL-TAYLOR 450 WATT TRANSMITTER

This complete phone and CW Transmitter has been designed around the National type NTE exciter unit which is unique in that it will furnish both RF and audio excitation for the high powered stages. The RF output is in the order of five to ten Watts and the audio output is ten Watts. From this it can be seen that it is only necessary to build a buffer and final amplifier stage to complete the RF portion of the Transmitter and the class B modulator can be driven directly from the output of the NTE unit. The RF portion of the NTE unit is band switching by merely pushing a button for the band desired. Further flexibility of frequency is obtained by using a National 4 in 1 crystal holder or a National type CHV crystal holder which permits tuning of the crystal over considerable range. Either of the above units will plug into the NTE unit with no alterations.

A pair of T-55 tubes were selected as the final amplifier due to their ability to operate efficiently at all frequencies at 450 Watts input. A single TZ-40 was selected for the driver for the final amplifier due to its small size and ease of drive. For the class B modulator, a pair of TZ-40's were chosen due to their ability to deliver 225 Watts of audio. Only two power supplies are necessary to complete the Transmitter. A 1250-1500 Volt supply that will deliver 300 MA is required for the final amplifier and a 1000-1250 Volt supply is necessary for the class B modulator. The normal power input is 400 to 450 Watts and the frequency range 3.5 to 30 MC.

Unit Number One

This unit contains the RF driver and final amplifier. In general, the final amplifier is mounted in the center and symmetrical on a Standard 17 x 13 x 3 inch chassis leaving sufficient space on the right side to mount the TZ-40 driver stage. On the rear of the chassis and to the right there is mounted a 5 prong National socket into which is plugged the proper FXT unit for the desired operating frequency. Immediately below the FXT unit on the rear of the chassis is mounted an Amphenol type S3S socket. Into this socket is plugged an Amphenol type 70-3S plug, which is used to connect the link from the NTE unit to the Transmitter. As one side of the link is grounded, the use of the 70-3S plug insures that the proper side of the link is grounded each time the plug is inserted. Immediately in front of the FXT unit the single TZ-40 is mounted. In front of the tube the tank coil is mounted while the tank condenser is mounted under the chassis. The leads through the chassis are through 3/8 inch rubber grommets with wires formed so that they pass through the center of the hole. The neutralizing condenser is mounted under the chassis in order to obtain shortest possible lead length. This may seem a bit awkward; however, once adjusted, there is no need for making further adjustments. The plate coil for the TZ-40, as well as the grid coil for the final amplifier, is wound on National XR13 forms and used with National type PB5 plugs and XB5 sockets. A link is used to couple the two circuits. National type TMSA-50D condensers are used to tune both the plate of the TZ-40 and the grid circuit of the PP T-55's. The final amplifier is a conventional push pull class C amplifier using a combination of cathode and grid leak bias. As it is impractical to use cathode bias to give the T-55's sufficient bias to allow keying of the oscillator and complete protection in case of

excitation failure, it was decided to use sufficient cathode bias to limit the tubes to approximately twice their rated plate dissipation without excitation. This is accomplished by means of a 200 ohm 20 Watt Ohmite resistor in the filament center tap circuit. The filaments are by-passed to ground for RF with .006 Cornell-Dubilier 600 Volt mica condensers and the cathode resistor must be by-passed with an 8MFD or larger electrolytic condenser. If it is intended to use CW with this transmitter, it should be equipped with a bias supply of approximately 100 volts in order to bias the final amplifier below cut-off when the key is open. The final amplifier tuning condenser, National type TMA100DA is mounted on National G5 cone insulators by means of the aluminum mounting brackets supplied with the condenser. Directly above the condenser is mounted a Barker & Williamson type TVL coil base and swinging link. The TVL assembly is mounted from the chassis by means of two National type GS4 insulators plus spacers 1/2 inch D and 5/8 inch high in order to raise the coil assembly to the proper height neutralizing condensers in all cases are National type NC800. The panel required for this unit is standard 14" x 19" either masonite or steel, the former being used for this transmitter with good success. One large National type "O" dial is used to tune the final plate circuit while two National HRO dials are used to tune the plate of the TZ-40 and the grid of the T-55's. Five small Simpson meters are also mounted on this panel and are used in the following circuits: Grid of TZ-40, plate of TZ-40, grid of final amplifier, plate of final amplifier and antenna transmission line.

Unit Number Two

This unit consists of the class B modulator and is identical with the class B modulator used in the dual RF unit transmitter on page 28 with the exception that the 866 rectifier and filament transformer is omitted since automatic modulation control is not used on this unit. Also it is necessary to use a 10 1/2 inch panel instead of 12 1/4 inch as used on the other transmitter in order to have the units fit in a Standard 35 1/4 inch cabinet.

Unit Number Three

This unit contains two power supplies which are mounted on a Standard 17 x 13 x 2 inch chassis and used with a 10 1/2 inch panel. Little need be said about the mechanical layout of this unit as the photograph takes care of this. As this unit had to be mounted on a 2" chassis it was impossible to mount the filament transformers under the chassis. Advantage was taken of the above chassis mounting feature of the National type CIR sockets. This gives a great safety factor against voltage break down and saves considerable mechanical work on the chassis as only a 1/8 inch hole is required instead of a socket hole. Only a single section filter system is used, which consists of a swinging choke and a 4 MFD Cornell-Dubilier condenser in both cases. This combination is ample for good amateur telephony. A guardian type R100 single pole relay is used to close the primary circuit of both plate transformers which eliminates the necessity of installing a large switch capable of switching the heavy primary current and simplifies remote control.

Coil Chart for National Transmitter

Band	L ₁	L ₂	L ₃	L ₄	L ₅	L ₆	L ₇
80 Meters	2 turns No. 22DCC	35 turns No. 28 enameled close wound	60 turns No. 18 enameled 1 3/4" D close wound	1 turn No. 16	1 turn No. 16	60 turns No. 18 enameled 1 3/4" D close wound	B & W 80 TVL
40 Meters	2 turns No. 22DCC	18 turns No. 22 enameled close wound	30 turns No. 16 enameled close wound	1 turn No. 16	1 turn No. 16	30 turns No. 16 enameled close wound	B & W 40 TVL
20 Meters	2 turns No. 22DCC	8 turns No. 16 enameled double spaced	12 turns No. 16 enameled 1 3/4" D 2" long	1 turn No. 16	1 turn No. 16	12 turns No. 16 enameled 1 3/4" D 2" long	B & W 20 TVL
10 Meters	2 turns No. 22DCC	4 turns No. 16 enameled double spaced	6 turns No. 14 enameled 1 3/4" D 2" L	1 turn No. 16	1 turn No. 16	6 turns No. 14 enameled 1 3/4" D 2" L	B & W 10 TVL

Note: L₁ and L₂ are part of the National FXTB units. L₃ and L₆ are wound on National XR 13 forms which are mounted on National PB 5 Plugs with the exception of the 10 meter coils which are self supporting and mounted directly on the PB5 plugs.

Cabinet

All three units will mount in a standard 35 1/4 inch steel cabinet or relay rack. In this particular transmitter, two Johnson No. 52-50 ceramic feed-thru insulators were mounted in the top of the cabinet toward the rear and in the center for the antenna terminals. Directly below the insulators is mounted a Ward-Leonard type 507-531 isolantite insulated 110 AC operated antenna change over relay. This relay operates in conjunction with the primary of the plate transformers. Two Johnson No. 55 feed-thru insulators are mounted in the side of the cabinet for the receiving antenna connection. This arrangement is ideal where the same antenna is used for transmitting and receiving.

NATIONAL CO.—TAYLOR TUBES 450 WATT TRANSMITTER

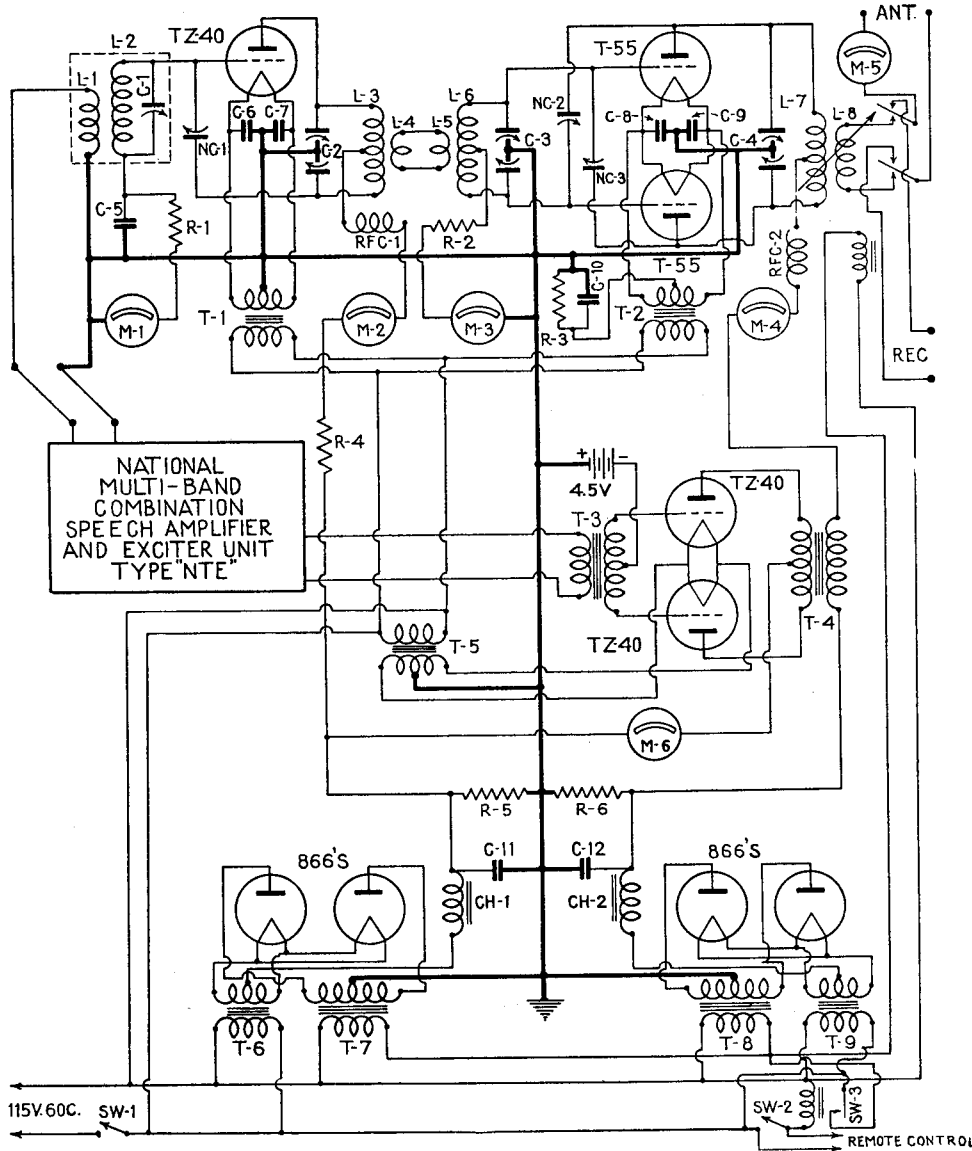

PARTS LIST

- R-1 —2000 Ohms 10 watt Ohmite
- R-2 —2500 Ohms 10 watt Ohmite
- R-3 —200 Ohms 20 watt Ohmite
- R-4 —5000 Ohms 50 watt Ohmite
- R-5 — 75,000 Ohms 50 watt Ohmite
- R-6 —100,000 Ohms 50 watt Ohmite
- C-1—Part of FXT Unit
- C-2, C-3—50-50 National type TMSA-50D
- C-4 —100mmf National Type TMA-100A
- C-5, C-6, C-7, C-8, C-9—.006 600 V mica C-D
- C10—8mfd electrolytic C-D
- C11—4mfd—1500V C-D
- C-12—4mfd—2000V C-D
- NC-1, 2, 3—National Type 800 neut. conds.
- RFC-1—2.5 m.h. National type R-100
- RFC-2—1 m. h. National type R-154U
- T-1—6.3V Thordarson T-19F97
- T-2—7.5V Thordarson T-19F94
- T-3—Input Thordarson T-15D82
- T-4—Output Thordarson T-14M49
- T-5—Same as T-2
- T-6, T-9—2.5V 10A Stancor P3024
- T-7—1000V-1250V-250MA P-5051
- T-8—1250V-1500V-350MA Stancor P-5052
- CH-1—Stancor C-1402
- CH-2—Stancor C1414
- M-1—0- 50MA Simpson Meter
- M-2—0-100MA Simpson Meter
- M-3—0-100MA Simpson Meter
- M-4—0-500MA Simpson Meter
- M-5—0-5A RF Ammeter
- M-6—0-500MA Simpton Meter
- SW-1—S.P.S.T. Toggle Switch
- SW-2—Same as SW-1
- SW-3—Guardian type R-100 Single pole relay

400 Watt Transmitter Schematic Diagram

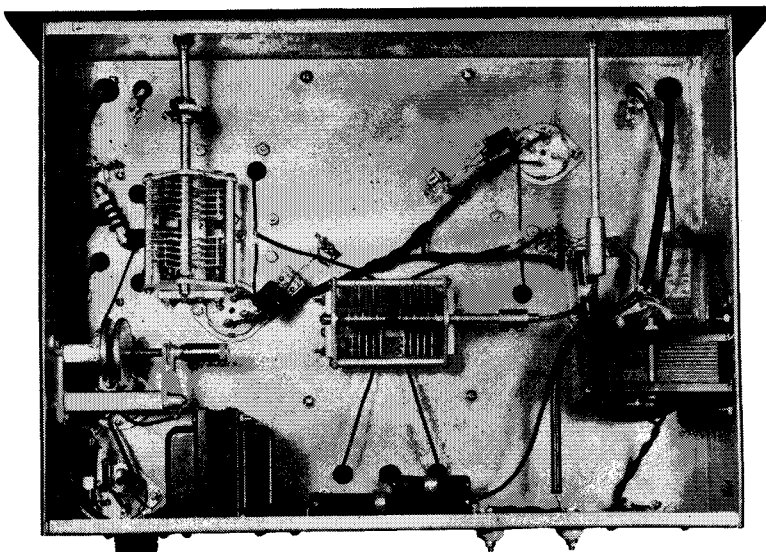

Bottom View — RF Unit
400 Watt Transmitter

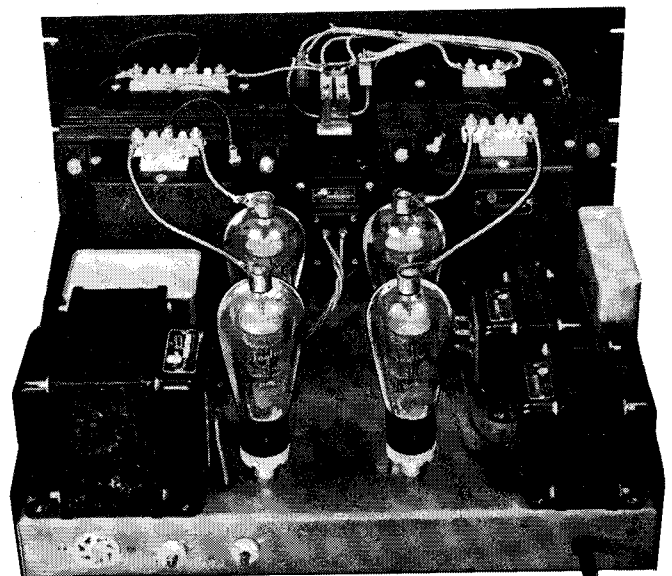

400 Watt Transmitter Power Supply

A 150 WATT 10 TO 160 METER COMPLETE TRANSMITTER

Revised 1939 MODEL *of the Famous* TAYLOR 150 WATT *10 to 160 Meter* TRANSMITTER

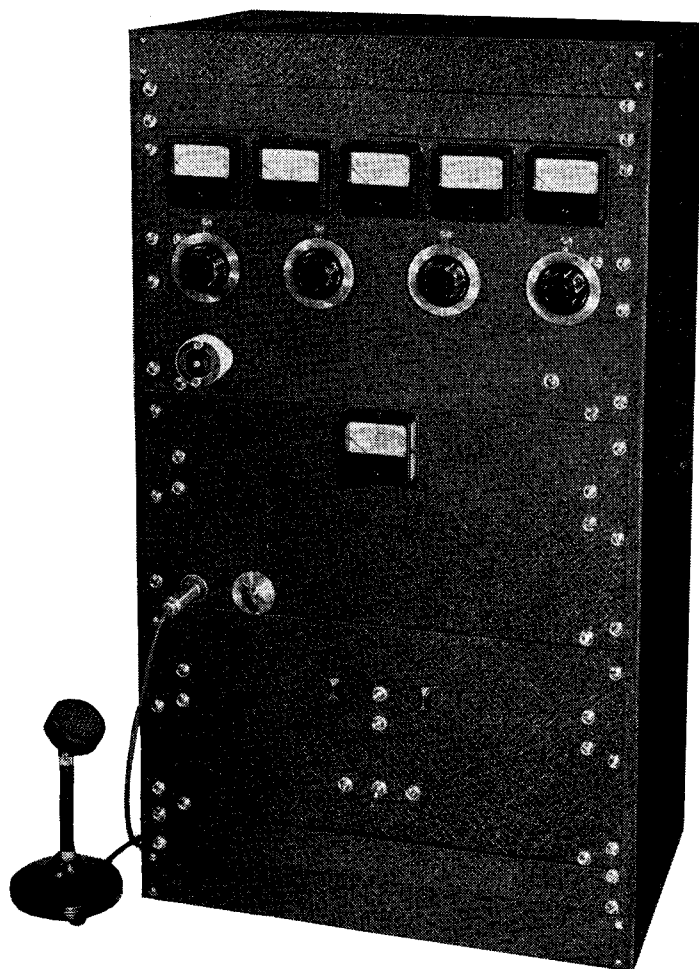

Several hundreds of this popular Transmitter are giving extremely satisfactory service on the air throughout the world. Due to its popularity, Taylor Tubes application engineers decided to rebuild the R.F. Unit to incorporate several new and desirable features such as Barker-Williamson air inductors, zero bias buffer tube, etc. Plate neutralization is used in place of grid neutralization and an improved parts layout increases efficiency. The most important change is the use of Cardwell's new 4 in 1 variable condenser which permits correct L/C ratios on all bands from 10 to 160 meters. The speech amplifier, modulator and power supplies remain exactly the same as last year.

The transmitter is housed in a Bud Radio No. 698 Cabinet which is 35½" high × 19½" wide × 14½" deep. Panels on the modulator and power supply chassis are 10" × 19" and either 10" × 17" × 3" or 13" × 17" × 3" chassis can be used. The R.F. unit is built on a 13" × 17" × 3" chassis and a 14" × 19" panel is required. All of these units are available in the Bud Radio line of metal ware. Meters used are Triplett or Simpson new small square type mounting in 2¼" holes. From left to right, the meters are oscillator plate, buffer plate, buffer and/or final grid, final plate and RF ammeter. The Toggle switch in the lower right hand corner of the RF panel is the DPDT switch for swinging the meter from buffer to final grid. The meter in the audio panel is in the Class B audio plate circuit. Dials are Bud Type 713.

CONSTRUCTIONAL DATA

By far the greatest problem in the design of an all-band amateur transmitter is that of maintaining suitable L/C ratios in the final stage. Insufficient capacity results in high harmonic content and poor linearity if modulated. Too much capacity results in poor efficiency. Because most transmitting condensers have a capacity ratio of about 4-to-1, a maximum of 3 adjacent bands may be covered with proper ratios. Operation on any other bands will leave a great deal to be desired. The transmitter to be described approaches the ideal condition over the full range from 1.75 to 30MC.

Only 3 stages are used, a T21, a TZ20 and a T55. Using a 20 or 40-meter crystal more than enough excitation to the final may be obtained on 30MC and on the lower frequencies the TZ20 loafs along delivering only about ¼ of full output when exciting the T55.

The T55 stage operates normally with grid currents of 20MA or more. In no event should the rectified grid current exceed the maximum rated value of 40MA. No improvement in performance is noted if the grid current exceeds 25MA and it is recommended that the stage be operated with 25MA of grid current under load. Condenser C12 may be used as the excitation control. If tuned to exact resonance, particularly on the lower frequencies, the grid current may be as high as 80MA. C12 should be tuned on the low frequency or high capacity side of resonance until the 25MA optimum value of excitation is obtained. Operation on the high capacity side of resonance is advantageous because it helps to make the driving voltage more sinusoidal.

The unit is very flexible and may be used in 4 different combinations on 20, 40, 80 and 160 meters, and in two combinations on 10 meters.

1. The unit may be operated straight through on the crystal frequency.

2. The crystal may be one half the output frequency, doubling in the crystal oscillator and working straight through in the buffer and final. This is recommended for 20 and 40.

3. The crystal may be one fourth the output frequency, doubling in the crystal stage and again in the TZ20 stage.

4. The crystal may be one half the output frequency, working straight through in the crystal stage and doubling in the TZ20 stage.

Combination 3 or 4 is necessary for ten meter operation, 3 with a 40 meter crystal and 4 with a 20 meter crystal. It was not found feasible to use a 20 meter crystal and double to 10 in the crystal stage with this oscillator circuit because the 20 meter crystal appeared to be a 60 meter fundamental type which operated on its third harmonic. With this circuit, the 10 meter output apparently was the sixth harmonic of 60, and was too low to be usable.

For c.w. operation the transmitter may be keyed in the cathode of the crystal stage or in any other conventional manner. If keyed in the crystal stage, the key should be in series with the r.f. choke and the following stages should be biased to cut-off with some source of fixed bias.

All of the grounds for each stage should connect together and to the chassis at a common point near the mechanical center for that stage to make all leads as short as possible. The chassis measures 10 by 17 by 3 inches and the layout should follow that illustrated as closely as possible.

The first two stages, the 6L6 and T20, make a satisfactory lower-power transmitter with an output of 40 to 45 watts from 20 to 160 meters and 15 to 20 watts output on 10. With suitable power supplies this would make an excellent portable transmitter. For phone work, the excitation to the T20 is sufficient for plate modulation.

1939 MODEL—150 WATT 10 TO 160 METER TRANSMITTER

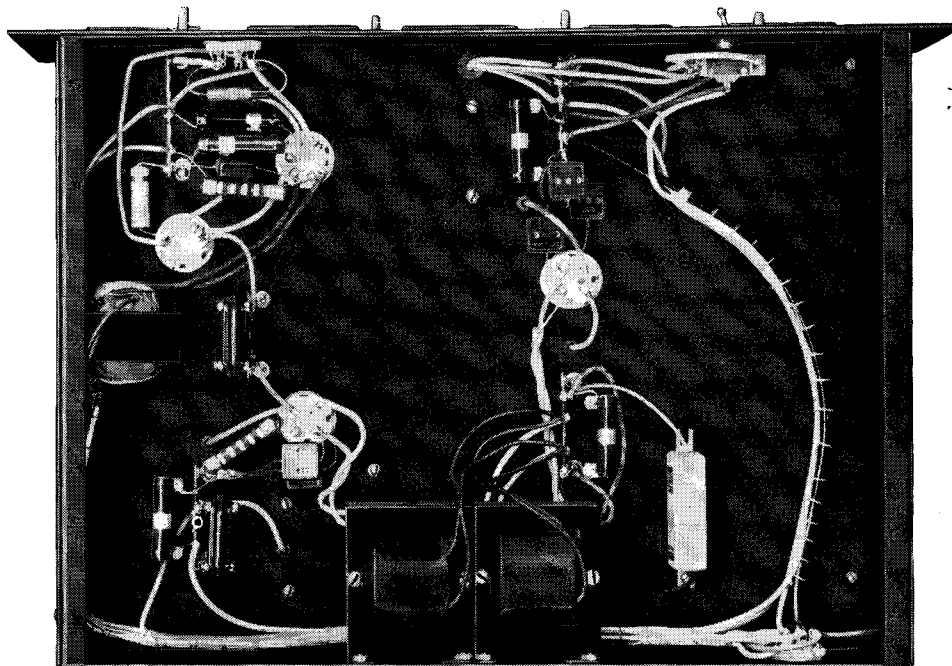
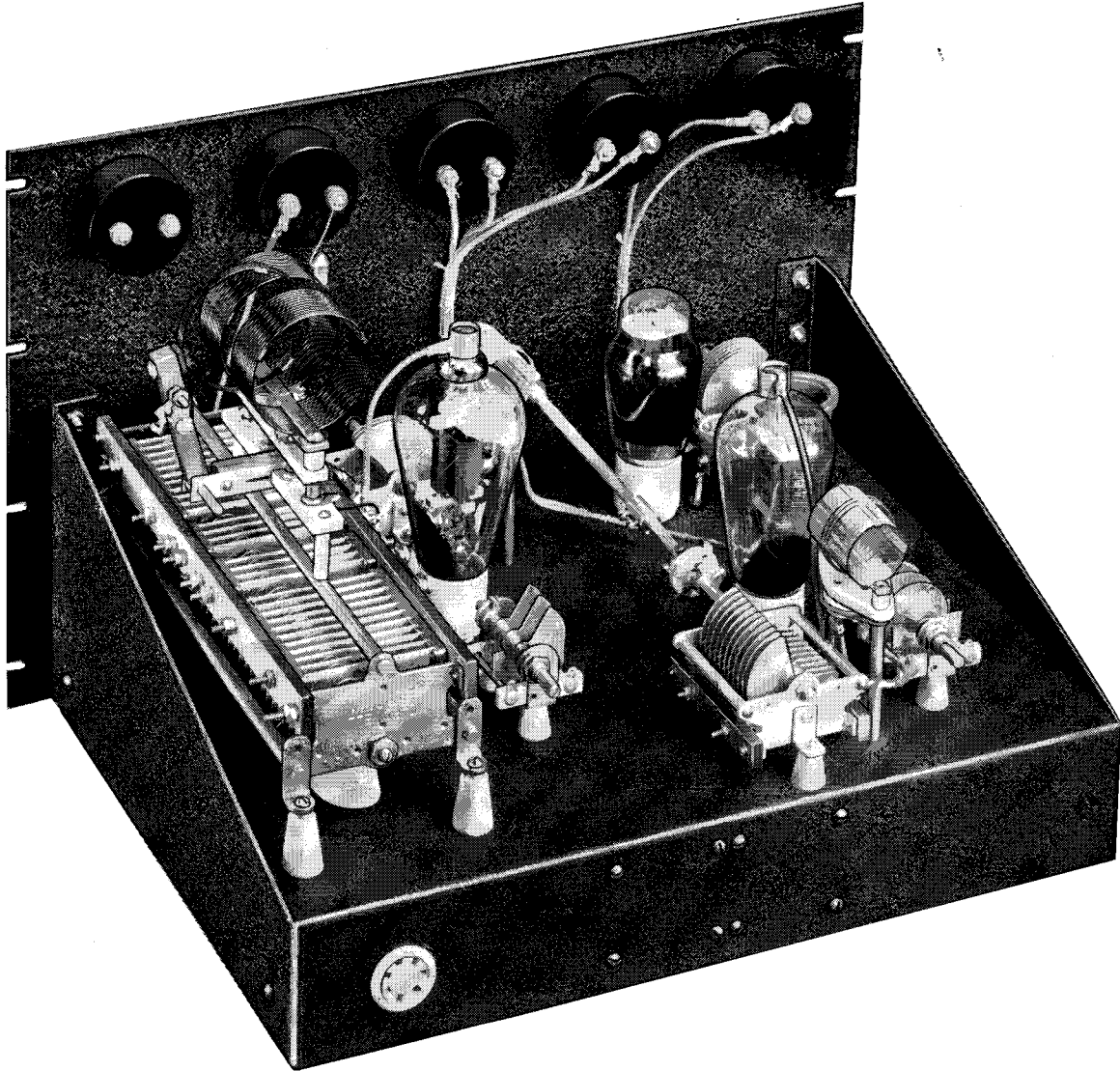

CONSTRUCTIONAL DATA

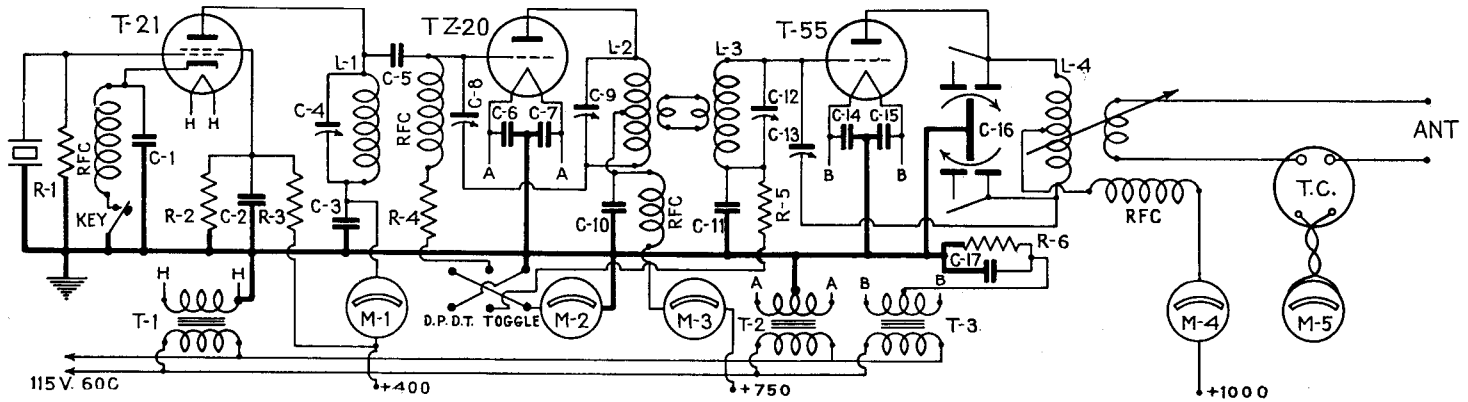

T21-TZ20-T55

R₁—100,000 ohm 1 watt.
 R₂—35,000 ohm 2 watt Ohmite.
 R₃—10,000 ohm 10 watt Ohmite.
 R₄—5000 ohm 10 watt Ohmite.
 R₅—400 ohm 10 watt Ohmite.
 C₁—.00015 mica 600V.
 C₂—C₃—.01 paper 600V.
 C₄—.0001 Cardwell Mr-105-BS.
 C₅—.0001 mica 2500V.

C₆—C₇—.006 mica 600V.
 C₈—6 mmfd. max. Bud 567.
 C₉—100 mmfd. Cardwell MT-100-GS.
 C₁₀—.002 mica 2500V.
 C₁₁—.002 mica 600V.
 C₁₂—105 mmfd. Cardwell MR105-BS (see text).

C₁₃—6 mmfd. max. stator plate removed Bud 567.
 C₁₄—C₁₅—.006 mica 600V.
 C₁₆—Double section Cardwell XE-160-70-XQ (see text).
 C₁₇—8 mfd. 450 V electrolytic.
 RFC—2.5 mr. RF chokes Bud.
 T₁—6.3V Stancor XP-4019, Thor-darson T-16F14.

T₂—7.5V Stancor XP-3022, Thor-darson T-16F13.
 T₃—7.5V Stancor XP-4018, Thor-darson T-61F85.
 M₁—0-150MA Triplet.
 M₂—0-100MA Triplet.
 M₃—0-150MA Triplet.
 M₄—0-300MA Triplet.
 M₅—0-2.5A RF Ammeter.

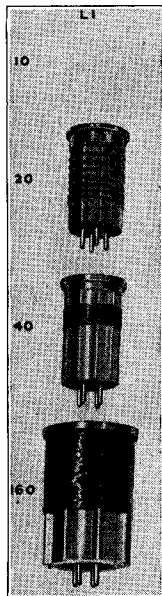

IMPORTANT COIL INFORMATION

If it is desired to eliminate 160 meter operation, it is practical to substitute for C₉ a Cardwell type MR50BS. If 160 meter operation is contemplated, it will be necessary to use a Taylor type 160 BVL coil in the final amplifier in place of the regular 160 BVL coil. Your jobber can supply you with Taylor type 160 BVL coils.

COIL DATA

Band	L ₁	L ₂	L ₃	L ₄
1.75 Mc.	45 t. No. 18 2 1/4" dia. close wound	B & W 160MCL	B & W 160MEL	B & W 160BVL
3.5 Mc.	26 t. No. 18 1 1/2" dia. close wound	B & W 80MCL	B & W 80MEL	B & W 80BVL
7 Mc.	12 t. No. 18 1 1/2" dia. close wound	B & W 40MCL	B & W 40MCL	B & W 40BVL
14 Mc.	8 t. No. 18 1 1/2" dia. 1 3/4" long	B & W 20MCL	B & W 20MCL	B & W 20BVL
28 Mc.		B & W 10MCL	B & W 10MCL	B & W 10BVL

CONSTRUCTIONAL DATA 150 WATT TRANSMITTER

In the modernization of this transmitter, the same general mechanical layout was used as it is in keeping with modern amateur practice and it facilitates the conversion of any units that now exist.

In mounting the tuning condensers, it is desirable to have all the shafts the same height in order that the dials will line up. To do this easily, it is only necessary to mount the oscillator plate tuning condenser, the buffer doubler plate condenser and the final amplifier grid tuning condenser on Johnson 1/2-inch Alsimag cones. The aluminum angles furnished with the Cardwell condensers are used to attach the condensers to the cone insulators. The method of attachment can be seen in the photograph. The final amplifier condenser is mounted with the rotor plates down and is supported on Johnson 1-inch Alsimag cones. Cardwell standard mounting angles are used to attach the condenser to the cone insulator. The neutralizing condensers are mounted on the chassis with 1/2-inch cone insulators. It is desirable to mount the coils for the TZ-20 plate and T-55 grid above the chassis. This is accomplished by mounting the two 5-prong Amphenol Steatite sockets 2 1/2 inches above the chassis on Cardwell type EMP mounting pillars. Four EMP pillars are required. The BVL coil base is mounted above the final amplifier tuning condenser. Mounting is accomplished by drilling and tapping two holes size 6/32, 2 1/16 inches each side of the center of the center tie rod of the Cardwell XE 160-70 condenser. The BVL base is spaced 1 inch above the tie rod by means of two Cardwell BHP mounting pillars and fastened to the rod by two 6/32 screws 1 1/2 inches long. The sockets used throughout are Amphenol Steatite. All wires that have to pass through the chassis go through rubber grommets.

In order to change the capacity of the Cardwell XE 160-70 condenser, it is necessary to employ some form of switch. As it was not necessary to switch from the front of the panel, it was decided to employ the simplest form of switch. The necessary changes are made at the same time coils are changed. The two small stator sections are wired in the circuit at all times and two links made from sheet copper are used to connect the two large outside sections in the circuit for 80 and 160 meter operation. The connecting links are approximately 3/8 inch wide and 1 1/2 inches long. Two holes are drilled to clear 6/32 screws and one hole is slotted out to the edge. This allows the links to be raised and lowered into position with little effort.

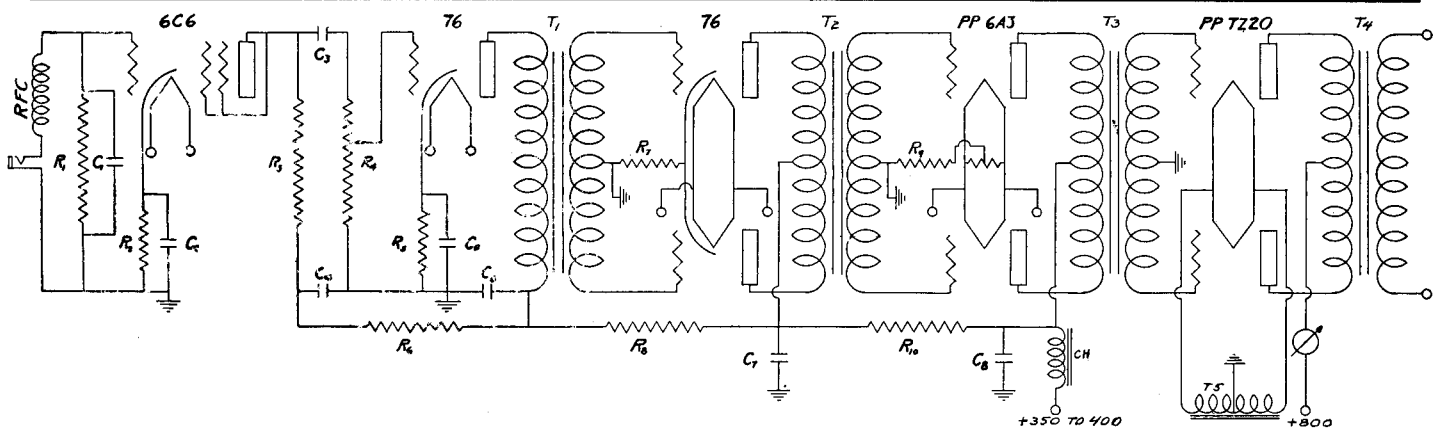

TAYLOR AUDIO FREQUENCY UNIT SCHEMATIC

PARTS LIST

- R₁—5 meg. 1 watt.
- R₂—2500 ohm 1 watt.
- R₃—250,000 ohm 1 watt.
- R₄—250,000 ohm variable.
- R₅—2500 ohm 1 watt.
- R₆—50,000 ohm 1 watt.
- R₇—1500 ohm 1 watt.
- R₈—20,000 ohm 1 watt.
- R₉—800 ohm 10 watt Ohmite.
- R₁₀—10,000 ohm 10 watt Ohmite.
- C₁—.0001 mica C-D.

- C₂—10 mfd. 25V electrolytic C-D.
- C₃—.01 600V paper C-D.
- C₄—2 mfd. 450V electrolytic C-D.
- C₅—10 mfd. 25V electrolytic C-D.
- C₆—2 mfd. 450V electrolytic C-D.
- C₇—8 mfd. 450V electrolytic.
- T₁—Single plate to pushpull class A grids.
Stancor XA-4206, General 2210, Thordarson T-13A34, Utah 7814.
- T₂—Pushpull 76s to class A prime 6A3s.
Stancor XA-4208, General 2294, Thordarson T-74D32, Utah 7815.

- T₃—Class B input.
Douglas D-101, Thordarson T-15D79, Stancor XA-4212, General 3273.
- T₄—Class B output.
Douglas D-100, Thordarson T-11N75, Stancor XA-2908, General 3330.
- T₅—Thordarson T64F35.
- CH—30 hy. 100MA filter choke.
General 1125, Stancor XC-1001, Thordarson T-13C30, Utah 4508.
- RFC—Bud 2.5 mh RF choke.

AUDIO UNIT

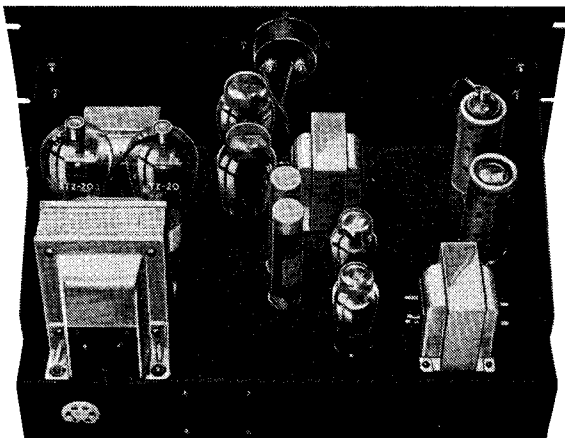

POWER SUPPLY CIRCUIT

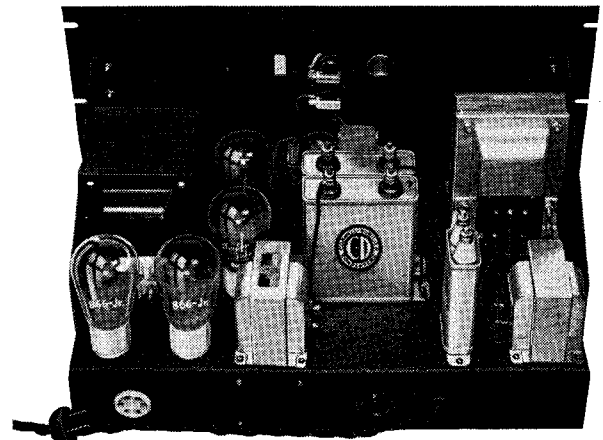
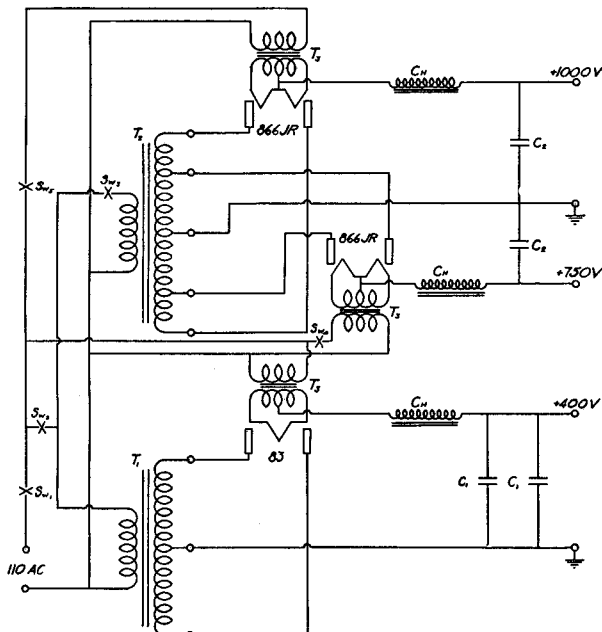

POWER SUPPLY UNIT

- T₁—400V DC after filter 150MA or more.
Stancor XP-3010, General 2814, Thordarson T-5303, Utah 1800.
- T₂—1000V and 750V DC after filter 250MA or more.
Stancor P-4030.
- T₃—5V 3A Stancor XP3026, General 2095, Thordarson T-16F11.
- CH—Swinging input choke 150MA or more.
Stancor C1400, General 2157, Thordarson T-6405, Utah 4500.
- C₁—4 mfd. 600V Cornell Dubilier.
- C₂—mfd. 1500V Cornell Dubilier.
- X₁, X₂, X₃, X₄, X₅, toggle switches.

AUDIO

This speech amplifier was designed to have sufficient gain for any of the crystal microphones and to have enough power output to drive any of the class B tubes we manufacture. In addition the cost was kept as low as possible consistent with good performance.

6A3's were selected for use in the class B driver stage because low impedance triodes make the best class B drivers. Incidentally pentodes and tubes with pentode characteristics such as 6L6's make the poorest class B drivers. The 2A3 or 6A3 is the closest approach to a constant voltage tube available to the amateur today. We recommend using tubes with the correct characteristics for the job rather than using tubes with inferior characteristics and attempting to compensate for these deficiencies with degeneration or other methods.

(Continued on page 43)

A ONE KILOWATT AMPLIFIER

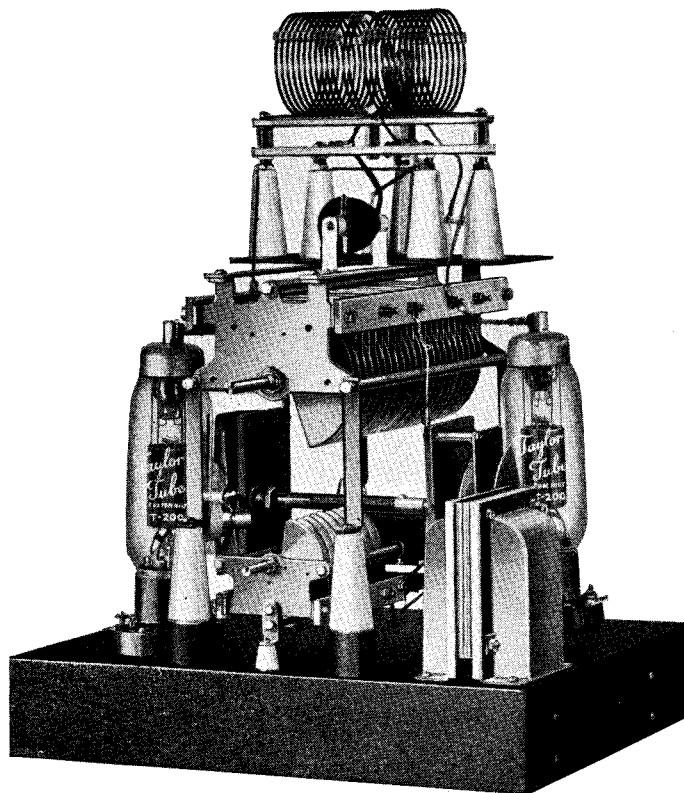

C1—Cardwell TJ200UD
 C2—Cardwell XC65XS
 C3—002 Mica Cornell-Dubilier 2500V.
 C4—002 Mica 5000V Cornell-Dubilier
 C5-C6—006 Mica Cornell-Dubilier 600V.
 C7—8MFD 450V (For Phone) Cornell-Dubilier
 NC—Johnson N375
 R1—2000 ohms 50 watts (Ohmite)
 R2—300 ohms 200 watt (Ohmite)
 RFC—500MA RF Choke (Bud)
 Plate Tank Coil—Barker-Williamson HDVL Coils
 Grid Coils—Barker-Williamson BVL Coils
 Fil. Trans.—Thordarson 19F96

Efficient high frequency operation with large tubes offers problems which are not encountered with smaller tubes. With the large tubes all of the components as well as the tubes are larger making it difficult to keep leads short. If the unit is used over a wide range of frequencies it often happens that it must be re-neutralized for each band.

Inability to hold neutralization over wide range of frequencies is invariably due to one or both of two reasons—lack of symmetry and long neutralizing leads.

The unit shown overcomes all of these disadvantages in an entirely satisfactory manner. It is symmetrical electrically and mechanically and the leads are as short as it is possible to make them with the large components necessary for plate modulation with 1 Kw input.

The tubes are T200's. These tubes feature high efficiency at moderate plate voltages with low grid drive requirements. The interelectrode capacities are low enough to permit efficient operation on frequencies as high as 30 MC yet not so low that any great amount of efficiency has been sacrificed. In addition its construction is the most efficient known.

It is not generally realized that low C tubes are inherently less efficient than higher C tubes. As a result higher plate voltages and

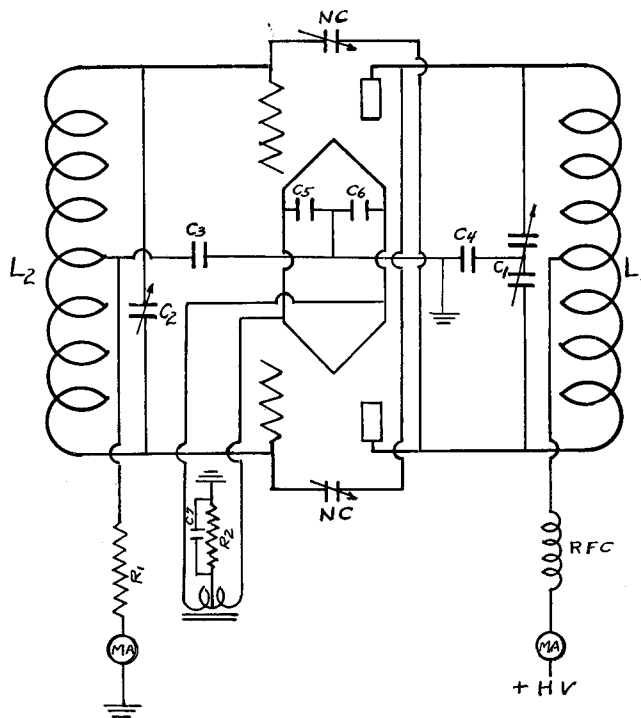

more grid drive must be applied to a low C tube than to those of more normal characteristics. The T200 represents the best compromise between the conflicting requirements of high efficiency at moderate plate voltages and minimum grid drive requirements together with efficient performance at the high frequencies.

It is impossible to accurately predict grid drive requirements because they may vary widely in various transmitters but about 80 watts of drive at the grids of the T200's should be adequate for plate modulation of a full Kw input. On the higher frequencies where circuit losses are considerably higher more buffer output must be available to compensate for these losses.

The entire assembly is mounted on a 13x17x3 inch chassis. The plate tuning condenser is a Cardwell TJ-200-UD and the grid condenser a Cardwell XC-65-XS. The neutralizing condensers are Johnson N375. Mycalex insulation is used on all of these condensers. Good insulation is exceedingly important on the higher frequencies. Barker-Williamson swinging link coils are specified for both grid and plate—therefore a BVL base and a HDVL base are required.

The maximum capacity per section of the TJ-200-UD is 200 MMFD per section giving 100 MMFD with the two sections in series. The minimum capacity is about 20 MMFD. This permits efficient operation with correct L/C ratios on the 20, 40, and 80 meter bands. With an input of 2000 volts, 500 MA the capacity in the circuit should be 11 MMFD on 10, 22 MMFD on 20, 45 MMFD on 40, 85 MMFD on 80 and 170 MMFD on 160 for best efficiency with good linearity for phone and minimum harmonic content. If 10 meter operation is desired a condenser with a lower minimum should be used and a higher capacity condenser would be required for 160 meter operation.

The bias is furnished partially by the cathode resistor and the balance by the grid resistor. This saves the cost of a bias supply because the plate current will drop to a safe value if the excitation fails or is removed. The cathode resistor should be bypassed with an 8 MFD electrolytic condenser if the stage is modulated.

814's, 822's or T125's may also be used in this unit. (Change neutralizing condensers for 814's and 822's.)

A MOST ECONOMICAL 100 WATT GRID-MODULATED PHONE RIG

COURTESY—RADIO—JAN. 1937 ISSUE

By FAUST GONSETT, W6VR

This transmitter gives just about the maximum in watts per dollar for a phone transmitter. It delivers 110 watts on 75 and 160 meters, and about 90 watts of carrier on 20 meters. It requires but one inexpensive high-voltage supply, which need not have good regulation, and needs no expensive modulating equipment.

What we are after is a tube with "lots of plate dissipation per dollar," as the plate dissipation is the chief limiting factor of output in a grid-modulated rig. The 814, with its 200-watt plate dissipation, is the most economical tube from this standpoint.

With a 1500 volt power supply, the transmitter delivers 110 watts on 75 and 160 meters, and about 90 watts on 20 meters. These outputs are obtained without exceeding the rated maximum plate

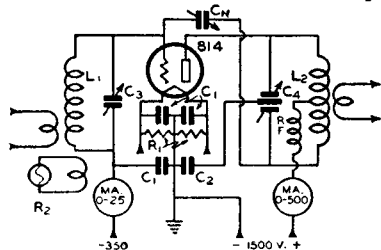

Wiring Diagram of the 100-Watt Grid-Modulated Stage

- | | |
|--------------------------------|-----------------------------------|
| C ₁ —01 μfd. mica | NC—25 μfd., 6000 |
| C ₂ —002 μfd. mica, | volt spacing |
| 5000 volts | R ₁ —30 ohms, c.t., 10 |
| C ₃ —100 μfd., 2000 | watts |
| volt spacing | R ₂ —32 volt 15 watt |
| C ₄ —210 μfd. per | "farm" Mazda |
| section, 3000 volt | lamp |
| spacing | |

As has been repeatedly pointed out, a grid-modulated stage works into a much lower impedance load (tighter antenna coupling) when properly adjusted than does a plate-modulated class C amplifier. For this reason, the plate tank should not be low "C", but rather "medium C", especially in a single-ended amplifier as is this one. With a plate tank condenser of the value specified in the diagram, the coils should be "pruned" so that the condenser resonates with plates nearly all the way in for 160 meters, 2/3 of the way in on 75 meters, and a little less than half way in for 20 meters.

The amplifier is neutralized by the "grid dip" method. The swamping lamp is uncoupled and the excitation run up to give a more substantial reading on the grid meter. This makes the neutralizing process a simple matter. After the neutralizing, the lamp is coupled up to nearly normal brilliancy. The excitation is adjusted to the 814 (as read by the grid meter) until the stage modulates up properly when the antenna is coupled so as to load the amplifier to 200 ma. At rated input, if the stage modulates downwards the excitation must be reduced, and the antenna coupling increased to bring the input back up to 300 watts. If the tube runs too hot at 300 watts input, it will be necessary to decrease the antenna coupling and then bring the input back up to 300 watts by increasing the excitation. When the right combination of excitation and loading is obtained, the tube will be running at normal dissipation and the distortion will be quite low at 95% modulation. The plate meter will kick upwards very slightly on modulation peaks and an r.f. indicator coupled to the output tank or feeders will give an occasional upward kick. The modulation may be checked by means of any of the common modulation monitors.

When properly adjusted, the harmonic distortion is lower at 95% modulation than with the majority of plate-modulated rigs on the air, but as is characteristic of all grid bias modulated transmitters, the distortion climbs very fast between 95% and 100% modulation. But as we have yet to see a pair of ears than can tell the difference between 95% modulation and 100% modulation, this is of little consequence.

The power supply need not have good regulation, as the plate current swings but 5% or so under modulation. A slight voltage drop due to poor regulation would do about as much good as harm anyhow, as it would tend to buck the slight upward carrier shift that is characteristic of this type grid-modulated amplifier when fully modulated. Do not be alarmed about the mention of carrier shift. It is almost imperceptible when the transmitter is properly adjusted, and is no greater than that of 90% of the high-level-modulated transmitters used by amateurs. As the power supply need not have good regulation, it can be constructed at a lower cost. You may even use condenser input if you wish. The only requirements are that it be free from hum and that it deliver 1500 volts at a load of 200 ma.

The rest of the transmitter is conventional, hence is not shown.

dissipation of the tube. By using a higher-voltage power supply it should be possible to get more output with the same plate dissipation, but the slight increase in output was not considered worth while. Higher voltage tuning and filter condensers would be required, increasing the cost of the amplifier and power supply. The outputs listed were obtained with very low distortion at 95% modulation of the amplifier, and represent a very high "watts per dollar" factor.

The r.f. lineup consists of a 6A6 exciter, link coupled to a T-20, which is link coupled to the grid-modulated amplifier. The 6A6 exciter has a 100 ma. power supply that delivers 350 volts under load. The positive of this supply is grounded and 350 volts of negative bias obtained in this way for the grid-modulated stage. The 6A6 exciter acts as a low-resistance bleeder, giving good regulation to the bias voltage, a well-regulated low-resistance bias supply being absolutely necessary for a grid-modulated stage. This supply should be well filtered, as any ripple in the supply will show up multiplied in the carrier. (1% ripple will modulate the carrier several per cent.) This is because the grid-modulated amplifier is biased to approximately 3 times cutoff, and is "modulation gaining" with the low values of excitation used.

For the same reason the T-20 power supply should be well filtered, because if the r.f. output of the T-20 is modulated, the percentage ripple will be multiplied by the 814 stage. However, the T-20 supply is only 425 volts, and it may use cheap electrolytic condensers as does the 6A6 350-volt power supply.

Thus for the r.f. section, we have a 6A6, a T-20, and an 814. We have three power supplies to feed the r.f. section: A 350-volt 100 ma. supply for the 6A6 (and 814 bias), a 425-volt 100 ma. supply for the T-20, and a 1500-volt 200 ma. supply for the 814.

To improve the regulation further, a 15-watt, 32-volt (farm lighting) lamp is link coupled to the grid tank of the 814 as a "stabilizing load." This is preferable to wiring a "swamping resistor" permanently in the circuit. The link to the swamping lamp is adjusted for each band until the lamp glows with just slightly less than normal brilliancy. This combination of low-impedance r.f. driver and load stabilizer permits a substantial increase in the output.

Push-pull 6A3's were used in the output speech stage. The varying load offered by the grid of the 814 under modulation has little effect upon the audio waveform of the 6A3's. The output of the 6A3's is coupled to the 814 through a transformer designed to work out of 6A3 drivers into class B 203A grids. The whole secondary is connected in series with the lead to the bias supply. What line-up goes ahead of the push-pull 6A3's depends upon your own microphone and pet ideas as to tubes.

At first glance it would look as though the 3000-volt spacing of the plate tank tuning condenser of the 814 stage would not be sufficient to stand the modulation peaks. However, due to the fact that the tank is fairly high "C" and because the tube works into a very low impedance load (tightly coupled to the antenna) no trouble with arcing is encountered.

SHORT WAVE THERAPY

IT IS NOT THE POLICY OF TAYLOR TUBES, INC., to furnish circuit diagrams for Short Wave Therapy to the casual experimenter; however, bona-fide manufacturers will find our engineers willing and anxious to offer suggestions for bettering the performance of their equipment.

Amateur Radio Operators have, for several years, obtained MORE WATTS PER DOLLAR from the use of TAYLOR TUBES in their transmitters; likewise Short Wave Therapy manufacturers using TAYLOR TUBES in their equipment are reaping the same benefit.

We cannot emphasize too strongly the necessity for careful, conservative engineering and exhaustive tests, as it has been our experience that this is the only procedure that will give satisfaction to both manufacturer and user.

TUBE INSTALLATION HINTS

The heart of a vacuum tube is its filament. Improper operation of the filament will shorten its life.

Although small variations in filament voltage are compensated for in the designing of our tubes, most satisfactory results are obtained when filaments are operated at their rated voltage. Lower voltage limits the electron emission of the filament and generally results in the over heating of the tube, while higher voltage will rapidly dissipate the supply of thorium in the filament.

Use sockets with large sweeping contacts. Poor contact between socket springs and tube prongs will cause a drop in filament voltage. Heavy well soldered leads are very essential. Light tube at rated filament voltage for ten minutes before applying plate voltage for the first time. Preheating of filament after first installation is not necessary.

STANDARD RECTIFIER CIRCUITS

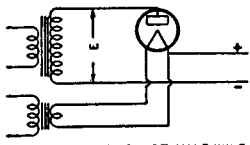

FIG. 1

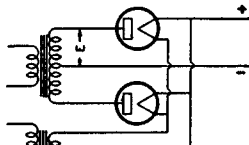

FIG. 2

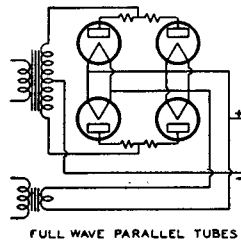

FIG. 3

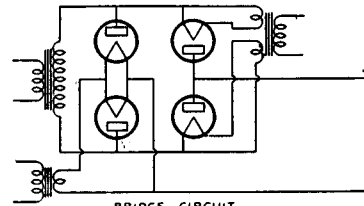

FIG. 4

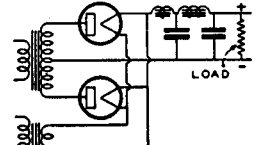

FIG. 7

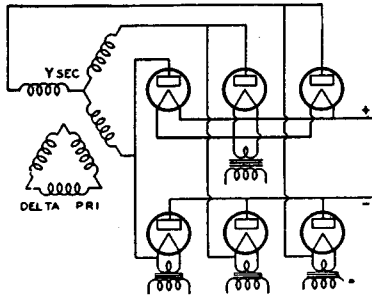

FIG. 6

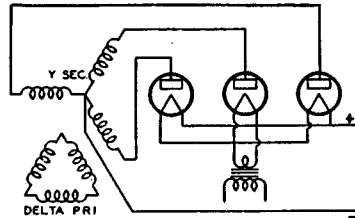

FIG. 5

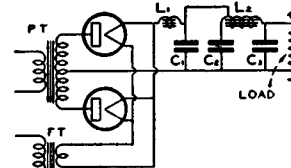

FIG. 9

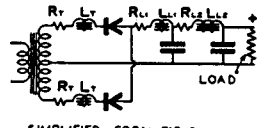

FIG. 8

Figure No.	Transformer Volts E	DC Output Volts at Input to Filter	DC Output Current In Amperes
1	.7 x Inv. Pk. Vtg.	.45 x E	.33 x Pk. Plate
2	.35 x Inv. Pk. Vtg.	.9 x E	.66 x Pk. Plate
3	.35 x Inv. Pk. Vtg.	.9 x E	1.32 x Pk. Plate
4	.7 x Inv. Pk. Vtg.	.9 x E	.66 x Pk. Plate
5	.43 x Inv. Pk. Vtg.	1.12 x E	.83 x Pk. Plate
6	.54 x Inv. Pk. Vtg.	2.25 x E	1.0 x Pk. Plate

Figures 1 to 6 illustrate typical rectifier circuits applicable to amateur use. The single-phase half-wave circuit of Figure 1 is not very popular due to the fact that the ripple is of greater magnitude and being of lower frequency than other systems is more difficult to filter. With choke input, the DC voltage will be approximately .45 that of the r.m.s. voltage E. Figure 2 illustrates the full-wave single-phase circuit which every amateur is familiar with. Figure 3 is identical in nature with Figure 2, except that four tubes (more if desired) are used to obtain higher current output. The resistors shown in the plate circuits of these tubes are very essential, otherwise one tube will generally take most of the load with the natural result that the tube life is greatly decreased; a drop of about six volts across these resistors will insure stability. Figure 4 shows a bridge circuit with four tubes, its advantage is that high DC voltages can be secured without expensive (high peak inverse voltage) tubes and with low voltage transformers. For full-wave rectification the DC voltage can be increased by using the entire secondary output of the plate transformer, in fact, the voltage will be exactly doubled; of course, this halves the current output due to the transformer current carrying limitations. Figures 5 and 6 are similar to that of Figure 2, except that they apply to three-phase circuits. In the circuit of Figure 5, each tube carries current for one-third cycle. The circuit of Figure 6 is very commonly employed in high power transmitters where three-phase power is available due to the high DC output voltage attained. This circuit has the added advantage that the ripple frequency is high, being six times the supply frequency, allowing simple filtering.

THIS ENTIRE PAGE FROM "THE RADIO HANDBOOK"

Courtesy Pacific Radio Publishing Co.

MODULATION

A carrier is modulated by varying its amplitude. Frequency modulation is illegal, and in a properly designed transmitter there must be adequate isolation between the modulated and frequency control stages to prevent any frequency modulation caused by interaction between them. One intermediate or buffer stage with separate power supplies for modulated and oscillator stages usually provides sufficient isolation to reduce frequency modulation to a negligible value.

Amplitude modulation may be accomplished by varying the efficiency of an amplifier as with grid modulation or class B linear operation. It may also be accomplished by varying the DC input. This is usually called plate modulation.

For 100% undistorted amplitude modulation, it must be possible to vary the carrier voltage and current between zero and twice the carrier value. Twice the voltage and current results in peaks which are 4 times the carrier value and the average power output with sine wave input will be 50% greater under 100% modulation conditions than with the carrier only. With input wave forms other than sine waves the instantaneous peak power will still be 4 times the carrier value but the average power may be other than 50% greater. With speech wave forms the average increase in power is usually about 25%.

With efficiency modulated amplifiers the input remains constant under modulation. So if the peak output is to be 4 times the average or carrier value the stage must be operating at low efficiency when unmodulated. Under modulation the average output increases while the DC input remains constant so the plate dissipation decreases.

Efficiency modulated amplifiers are of two general types. With one type the excitation remains constant and the grid bias is varied. This is usually called grid modulation. With the other type, class B linear operation, the bias is held constant and the excitation varied by modulating the previous stage. Under normal conditions the maximum carrier efficiency with low distortion is about 33%. A tube with a plate dissipation of 200 watts would permit an input of 300 watts and a carrier of 100 watts. Comparatively large tubes are required for a given output but comparatively little audio equipment is required.

With plate modulated amplifiers enough audio power is superimposed on the DC supply to swing the plate voltage from zero to twice the unmodulated value. This power is developed by the modulator and added to the DC input. With sine wave input to the speech equipment the average power required is equal to 50% of the DC input. With speech input the average power is about 25% of the DC input but in either case the instantaneous peak power is the same as in the case of efficiency modulated amplifiers and the peak output is equal to 4 times the carrier power. The tubes in the modulated amplifier operate at high efficiency—normally about 75%. A tube with a plate dissipation of 200 watts would permit about 800 watts of input and 600 watts of output or about 6 times the carrier with the same tube as in an efficiency modulated stage. A modulator that is capable of delivering 50% as much power with sine wave input must be used but even so such an installation, if Class B modulators are used, should cost less originally and less to maintain than one using efficiency modulation. For this reason plate modulation is used almost to the exclusion of other methods. In addition it is easier to get working and requires less critical adjustment. As mentioned previously the efficiency of efficiency modulated amplifiers increases during modulation reducing plate dissipation. With voice input the average reduction in dissipation over a reasonable period of time is not great enough to permit increasing unmodulated dissipation. Conversely with plate modulated amplifiers the average increase in plate dissipation with voice input over a period of time is not great enough to necessitate allowing for it, especially with **Taylor Carbon anode tubes** whose dissipation ratings are exceedingly conservative.

AUDIO

Continued from page 39

Cathode bias is used, since the output is adequate with the tubes operating class A, and therefore fixed bias is not necessary.

It was decided to use a push-pull 76 stage and a low ratio transformer ahead of the 6A3's so that if under unusual conditions the grids of the driver stage were driven positive the resulting distortion would be limited to that caused by bias shift only, instead of the far more serious distortion which would result if a high impedance class A input circuit were used.

The 6C6 and 76 furnish the desired amount of voltage gain. The filter choke, decoupling resistors, and by pass condensers filter the plate supply so that even a fairly high percentage of ripple in the power supply will not introduce hum in the amplifier.

Although a crystal microphone has high internal impedance the .0001 condenser does not have any appreciable effect on frequency response because of the characteristics of the microphone. If RF is still present another .0001 condenser from grid to ground of the second stage may help.

The speech amplifier-driver was built up as shown on the same chassis as a TZ20 class B stage for the complete Taylor transmitter. The 6A3's are capable of far more output than is necessary to drive a pair of TZ20's but a large ratio of available power to required power is desirable for best results.

Many amateurs are under the impression that a low impedance line is necessary between the class B driver and the modulator if they are some distance apart. Actually class B grids are of low impedance and the grid leads may be extended the necessary distance in shielded wire. A properly designed class B input transformer will be built so that the coupling between windings will be as tight as possible to keep leakage reactance at the absolute minimum. This is extremely important. If two transformers are used with a low impedance line connecting them the leakage reactance must necessarily be higher than if only one transformer of equal quality is used. Consequently the use of a low impedance line may result in inferior results. If the use of a low impedance line is essential best design would be to put at least the driver stage with the modulator and use the line where the design requirements are not as stringent.

POWER SUPPLY

For the RF and modulator units 3 different voltages are necessary, 400 volts, 750 volts, and 1000 volts. The audio amplifier and crystal oscillator operate from the same 400 volt supply. Both the T20 buffer and TZ20 Class B stage operate at 750 volts and the final stage at 1000 volts.

The 400 volt transformer is tapped for 400 or 500 volts at 175MA. The total drain for both speech amplifier and crystal stage is a maximum of about 150MA.

For the modulator, buffer, and final stage one power transformer designed to deliver 750 and 1000 volts from the filter with choke input at a total of 250MA is used to obtain both voltages. The final operates at 150MA and the buffer at about 50MA. The no-signal plate current to the modulators is about 25MA and swings to 60 or 70MA for 100% modulation so the average drain is about the maximum rating of the transformer. The buffer could be operated from the 750 volt supply with the modulator or from the 1000 volt supply thru a dropping resistor. It was not operated from the 750 volt supply because of the inevitable fluctuation of voltage with change in modulator plate current. In the average amateur transmitter the meters from the only method of checking performance so the change in meter readings under modulation is extremely undesirable. As a result the T20 buffer is operated from the 1000 volt final stage supply thru a 5000 ohm 20 watt resistor. As a result all of the meters except those in the modulator plate and feeder stand still as they should under modulation. Wherever possible, the Class B modulator power supply should not furnish power to any RF stage. If the same transformer is used for modulator and RF it is advisable to use separate filters for each. The same mercury vapor rectifier tubes may be used for both.

TUBE TYPE COMPARISON CHART

TAYLOR	RCA	WESTERN ELECTRIC	UNITED	AMPEREX	GE
203A	203A	295A	303A	203A	—
211	211	242A	311	211D	FP197
211C	—	261A } 276A }	361A } 376A } 311C }	261A } 276A } 211C }	—
211D	211	242A	311	211D	FB197
HD203A	—	—	—	203H	—
HD203C	—	—	303U	—	—
HD211C	—	—	311CH	211H	—
303C	—	—	303CU	203H	FP198
805	805	—	905	805	—
814	*	—	HV12	—	—
822	—	—	HV27	—	—
845	845	284B	945	845	—
T200	—	—	—	FP252	—
866	866	—	966	866	—
872A	872A	—	972A	872A	—
249B	—	249B	—	249B	—

*Taylor 814 and RCA 814 are not similar types.

BALANCED SINGLE END AMPLIFIER NEUTRALIZING CIRCUIT

How would you like to use any triode in a single ended RF amplifier with the stability and efficiency of push pull? Perfect neutralization on all bands through 5 meters can be had by a slight change and at less cost than any other circuit.

The circuit, as built by many amateurs, is shown in Fig. 1 (a). This type of circuit can be perfectly neutralized with plate voltage removed; but as soon as plate voltage is applied many symptoms of bad operation are evident, the tube may run hot, the grid current may go up instead of down, unexplained jumps in the meters and frequency, with modulation or keying are evident, RF chasing all over the place, etc.

Fig. 1 (b) shows the neutralizing circuit and is very evidently unbalanced so that a change in the grid affects the plate in a regenerative manner.

Now look at Fig. 2 (a); by removing an expensive by-pass condenser and putting in a small air neutralizing condenser as a balance, denoted by B, at long last we have a balanced single ended circuit. See Fig. 2 (b). In this figure if condenser N equals the plate to grid capacity and condenser B equals the plate to ground capacity and the grid cannot affect the plate tuning and so the tube remains neutralized under all conditions.

Condenser B may be like the neutralizer and must have spacing between plates of one-half or more than the plate tuning condenser spacing. Its capacity should approximately equal the plate to filament plus the plate side of circuit to ground but is not very critical. The tube is neutralized with B removed and no plate voltage, then B is connected and adjusted until no RF is in the plate circuit. Then plate voltage is applied and if necessary the condenser N may be slightly shifted to affect perfect neutralizing.

A split stator condenser may be used with center grounded direct or through a condenser, but must have twice as much capacity per section although needs only one-half the spacing between plates.

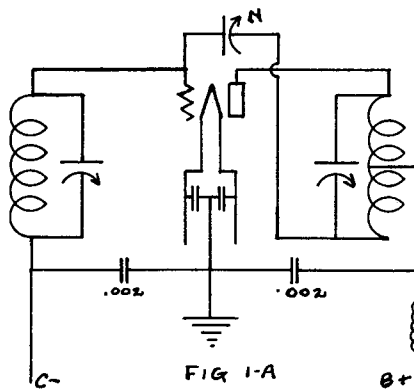

FIG. 1-A

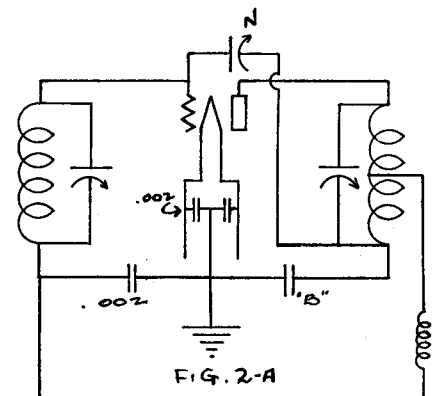

FIG. 2-A

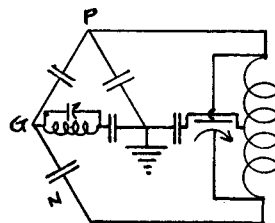

FIG. 1-B

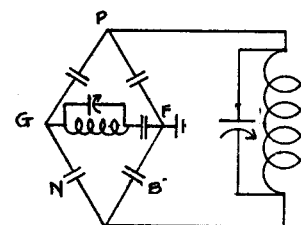

FIG. 2-B

If a split stator is used a flat metal plate on brackets to ground may be mounted close to the stator plates for condenser B. The metal plate must be polished and edges rounded to resist corona.

Because there is no regeneration this circuit may seem harder to drive, but is not, because all the power in the grid is useful as evidenced by a cooler tube. So try this circuit and that single tube you have on 20 or 10 meters even 5 and be surprised by its performance.

WE wish to sincerely thank these manufacturers who have so generously co-operated with our Engineering Staff in the building of the transmitters described in this manual. We have found their products to be of the best quality and recommend their use very highly.

American Phenolic Co.
Barker-Williamson
Bliley Crystals
Bud Radio, Inc.
Birnback Radio Co.
Allen D. Cardwell
Cornell-Dubilier
Decker Co.
Gordon Nameplates
Hammarlund
E. F. Johnson Co.

Kelvin Holders
Lenz Electric Mfg. Co.
National Co.
Ohmite
Simpson Meters
Stancor
Thordarson
Turner Microphones
Triplett Meters
Utah Radio Products
Ward Leonard Relays

Other Circuits using Taylor Tubes can be found in the following publications:

814 Grid Mod. 100 watt Xmtr—Jan. 1937 Radio.
T20's 3 Band Xmtr—Mar. 1937 Radio.
350 Watt Progressive Xmtr—June 1937 Radio.
T55 Xmtr—Jan. 1937 QST.
10 to 160 meter Xmtr—June 1937 QST.
T55 Transmitters—May and June 1937 All Wave Radio.
ARRL and Jones Handbooks

Taylor Tubes are used in Bassett, Harvey, Gross and Temco Transmitters

TAYLOR TUBES, Inc.
2341-43 Wabansia Avenue - Chicago

Foreign Representative
ROYAL NATIONAL CO.
Cable NATVARNCO
16 W. 61st St.
New York City

TUBES WITH A REAL GUARANTEE

PRINTED IN U. S. A.



GENTRY PRINTING COMPANY