

Instruction Manual

for the

PA3 3.1 MHz Switch Mode Plasma Tube Amplifier v1.00 with HS2 Heat Sink Assembly

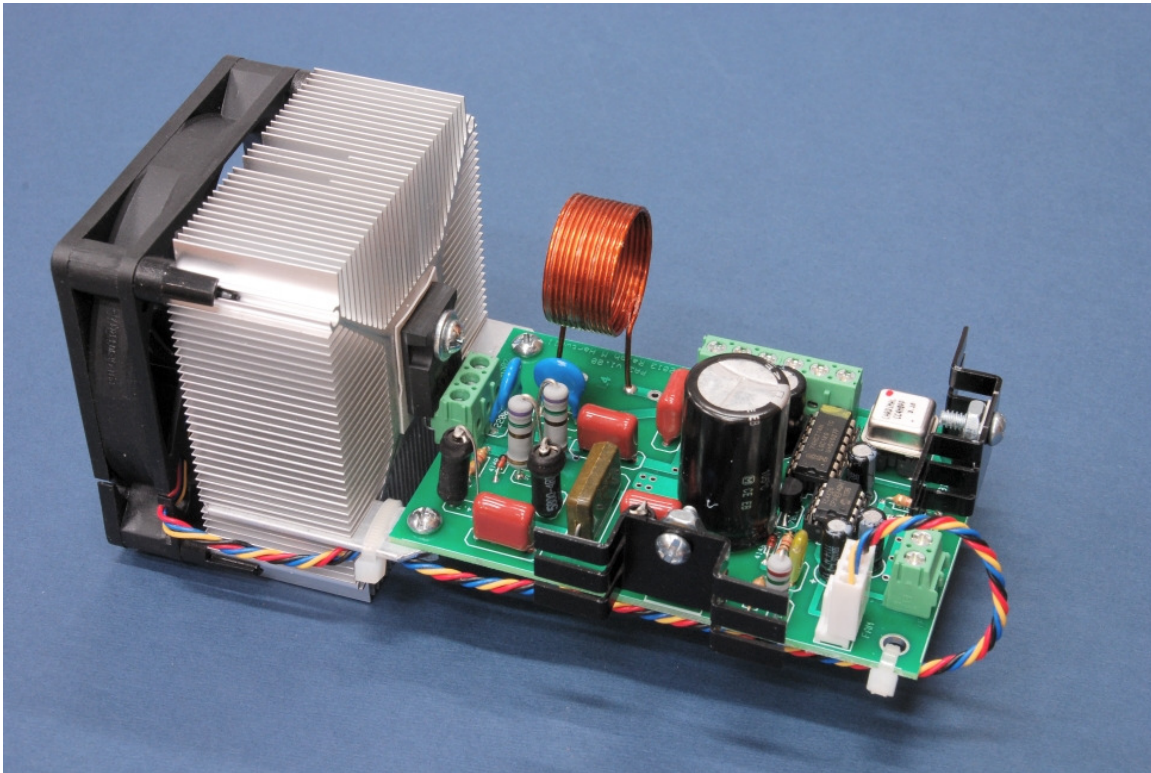

Manual v1.00 – 17 December 2013

Copyright © 2013 by Ralph M Hartwell
Spectrotek Services
All rights reserved

*** LEGAL AND MEDICAL DISCLAIMER ***

Spectrotek Services and Ralph M. Hartwell ARE NOT RESPONSIBLE for any damage or injuries of any sort or form that may be sustained by any person or persons, any animal, or to any equipment or any other thing or things while anyone is using, modifying, testing, or experimenting with the PA3 in any manner whatsoever. This device has not been inspected or approved by any governmental or medical agency or inspection service. No medical claims are made for, nor implied by, the sale or use of this device. Using the PA3 is done solely at your own risk.

You are advised to always consult with your physician or other health care professional at any time should you have or think you might have a health problem. Please check with your physician or other health care professional before starting any diet, exercise, taking over-the-counter (OTC) medications or supplements and especially before taking any prescribed medication. Never stop taking any prescribed medications without first consulting your physician.

RADIO FREQUENCY WARNING NOTICE

- The PA3 is a high-frequency switch mode power supply module designed to furnish a square wave modulated high voltage alternating current at a frequency of approximately 3.1 MHz across a 50 ohm load impedance.
- If the PA3 is installed incorrectly or used improperly, it is capable of causing severe radio frequency interference. To prevent this from occurring, observed the following warnings:
- The PA3 is to be used as a research device only, or as part of a complete system to drive a plasma tube.
- The PA3 is not intended to be used for any form of radio transmission in any manner whatsoever.
- The PA3 is not intended to be connected to an antenna or to any radiating element or to be used for any form of radio communications purposes in any manner whatsoever.
- The PA3 is designed solely to be a source of power to light a plasma tube.
- All electrical connections to the output terminals of the PA3 are to be made by the use of properly shielded 50 ohm coaxial cable capable of handling at least 500 watts at 3.1 MHz.
- All connections are to be made in such a manner as to minimize any RF radiation from the connecting wires to the PA3.
- The PA3 has been specifically designed to be driven by a TTL square wave signal that from a standard signal generator, such as the UDB-series of frequency generators or any other signal generator capable of producing a duty cycle modulated square wave signal with an amplitude of 0 to +5 volts.
- The operating frequency range of the PA3 has been restricted to a 1 MHz portion of the spectrum centered at 3.1 MHz.
- Any attempt to drive the PA3 with a radio frequency source such as a CB radio transmitter, will result in immediate destruction of the PA3.

Index and Table of Contents

Legal and medical disclaimer	2
Radio frequency warning notice	3
A note about the definition of the word “power” as used in this document	7
What does the PA3 do?	7
How much power can I get from the PA3?	7
What range of carrier frequencies can the PA3 use?	8
How can I power the PA3?	8
Connections to the PA3	9
PA3 terminal block identification	9
Connections	10
Mounting the PA3 and the HS2 Heat Sink / Cooling Fan assembly	11
The cooling fan on the HS2	11
RF shielding considerations to prevent interference to other devices	11
Electrically insulating the STW20NK50Z from the heat sink	12
Operation of the PA3	13
Power supply	13
Modulation signal voltage levels for square waves	13
Modulation signal voltage levels for sine waves	14
Operating conditions for the PA3 with various Bill Cheb plasma tubes	15
Using the PA3 with the UDB1108S	16
Using the PA3 with the GB-4000	16
RF coupling systems	17

Commercial antenna tuners	17
Tuning waveforms	17
Replacing the STW20NK50Z on the PA3	20
Specifications	22
Warranty and contact information	23
Schematic diagram of the PA3 v1.00	24
Waveforms	25 - 29

List of Figures

Figure 1:	Page 9	PA3 Terminal block identification.
Figure 2:	Page 18	PA3 Output waveform across a 50 ohm load.
Figure 3:	Page 19	Output waveform of the PA3 when tuned incorrectly.
Figure 4:	Page 19	Output waveform of the PA3 when tuned incorrectly.
Figure 5:	Page 24	Schematic diagram of the PA3 v1.00.
Figures 6 – 11:	Pages 27 – 29	Output waveform of the PA3 when connected to a 50 ohm dummy load.

A note about the definition of the word POWER as used in this document.

In this document, unless otherwise specified, when the word "**power**" is used it will mean **peak power**. For example, with a 50% duty cycle, 300 Watts peak power is the equivalent of 150 Watts **average power**. Likewise, with a 100% duty cycle, 300 watts peak power is equivalent of 300 watts **average power**.

What does the PA3 do?

The PA3 amplifier has been designed to allow researchers who already have an accurate signal generator which will supply adjustable square waves to construct their own high power plasma tube system. During operation, the PA3 requires nothing more than a modulation frequency input from an external signal generator and a source of DC power.

The modulation signal source may be a stand-alone frequency generator such as a UDB1108S, an F-series generator such as an F165, a GB-4000, or even a sine wave output signal generator. Modulation frequencies between 4 Hz and 400,000 Hz may be used with the PA3.

The PA3 has an on-board 3.1 MHz carrier oscillator module which may be swapped for an oscillator module of a different frequency should this be required.

What type of amplifier is the PA3?

The PA3 is not a conventional RF power amplifier, and it cannot be used as such. It will not accept an RF drive signal from a conventional transmitter, such as a CB radio. The PA3 is actually a high frequency switch mode power supply designed to convert DC power into semi-square wave pulses of energy at 3.1 MHz and at a high voltage output.

How much power can I get from the PA3?

Depending upon the size and efficiency of the heat sink on which you have installed on the PA3, the power output of the PA3 may be between 300 to 500 Watts peak power / 150 to 250 Watts average power when using a 50% duty cycle modulation.

If the PA3 is installed on a sufficiently large heat sink, then higher duty cycle modulation may be used. This will provide a corresponding increase in output power from the PA3. With a large enough heat sink, the PA3 is capable of operating in excess of 500 watts peak power output. When mounted on the HS2 heat sink assembly, the PA3 will operate at full rated power.

For most large plasma tubes, 300 watts peak power is sufficient to properly drive the tube. Be aware that operation at high power levels may cause overheating and possible damage to your plasma tube. Please consult with your plasma tube manufacturer to determine the correct power level for your plasma tube.

What range of carrier frequencies may the PA3 use?

The PA3 will operate across the range of 2.9 to 3.5 MHz. Operation outside this frequency range may cause serious damage to the PA3. The optimum operating frequency is 3.1 MHz.

I am uncomfortable soldering wires to circuit boards. What do I do?

All connections to the PA3 are made using screw terminals, so no soldering is required.

How can I power the PA3?

The output amplifier section of the PA3 may be powered from any power supply that has an output voltage of 15 to 190 volts DC. The maximum current required is approximately 3 amperes, although normal power levels required for plasma tubes will usually require lower DC current levels.

A smaller power supply with a voltage of 20 volts DC at a maximum current of 750 mA is required to operate the signal processor circuits and to provide DC power for the heat sink cooling fan.

For best results when operating the PA3, the power supply should be both voltage and current regulated. It is advisable to install a fast operating 3 ampere fuse in the positive voltage line. Note that lower DC supply voltages will be required for operating smaller plasma tubes.

Connections to the PA3

All connections to the PA3 are made by using the small screw terminals that are located in the plastic terminal blocks mounted on the edges of the circuit board. These will accept either solid or stranded wires.

When tightening the screws, do not over tighten the screws to avoid damaging the connector. Just strip approximately 1/4 inch / 6 mm of insulation off the end of each wire and insert it into the hole in the terminal block, then gently tighten the screw to clamp the wire in place.

The following diagram (Figure 1) shows the relative position of the various connectors on the PA3. They have been color coded in Figure 1 for ease of identification. Note that the terminal blocks on the PA3 will usually all be the same color, either blue or green.

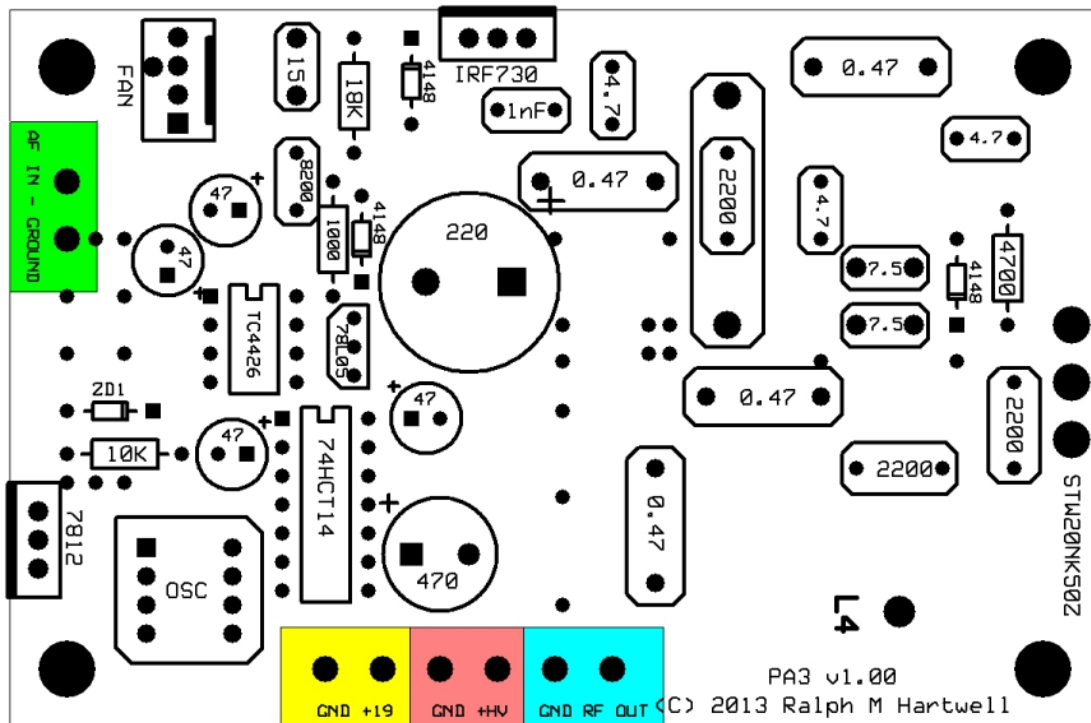

Figure 1

PA3 Terminal block identification as viewed on the component side of the board.

Please refer to Figure 1 for the location of the following connections.

(GND +HV)

This terminal block is used to connect DC power to the output amplifier stage of the PA3. The left connection is power supply negative, and the right connection is power supply positive.

The power supply output voltage MUST be isolated from the AC mains for safety.

(GND +19)

This terminal block is used to connect a source of +19 volts DC power to the signal processor stages of the PA3 and also to provide regulated +12 volts for the heat sink cooling fan. The left connection is power supply negative, and the right connection is power supply positive. Voltages between +18 and +22 may be used.

Note that the GROUND terminal next to the RF OUT connection, the GROUND terminal next to the +HV connection, the GROUND terminal next to the +19 terminal are all connected together and serve as the ground / earth connection for the PA3.

(RF IN - GROUND)

This terminal block accepts the square wave, TTL level drive signal from the signal source. You should use a length of standard coaxial cable or other shielded cable to make this connection. The characteristic impedance of the coaxial cable is not critical, so any shielded cable may be used.

Connect the cable shield to the LEFT terminal of the RF IN terminal block. This is the ground / earth connection.

Connect the center wire of the coaxial cable to the RIGHT terminal of the RF IN terminal block. This is the square wave signal input connection.

(GND - RF OUT)

This terminal block is the RF output of the PA3. Connection to this terminal block requires the use of shielded 50 ohm impedance, solid dielectric (not foam) coaxial cable between the terminal block of the PA3 and the matching system that will be connected to the plasma tube.

Connect the shield side of the coaxial cable to the left connection of the RF OUT terminal block.

Connect the center wire of the coaxial cable to the right connection of the RF OUT terminal block.

Mounting the PA3 and the HS2 Heat Sink / Cooling Fan Assembly

If you have purchased an assembled PA3 amplifier, it will be furnished already mounted on the HS2 heat sink / cooling fan assembly. The HS2 heat sink provides the proper cooling to allow the PA3 to operate at full rated power. Please be sure that nothing obstructs the flow of cooling air entering the fan or the warm discharge air leaving the heat sink.

When the PA3 is mounted on the HS2 heat sink, the result is a compact module that allows for easy incorporation of the PA3 into a complete plasma tube RF drive system.

The HS2 heat sink with the PA3 attached to it may be mounted in place in your system by the use of a clamp, a bracket, or some type of strap that will hold the heat sink assembly firmly in place. It is important that the airflow through the heat sink not be obstructed in any manner. A plentiful supply of cool air must be allowed to enter the fan and the heat sink assembly. Likewise, the warm exhaust air must be allowed to freely exit the area of the heat sink.

VERY IMPORTANT !!

If the unit is placed in an enclosure, it is advisable to mount the air intake side of the fan immediately adjacent to an opening in the enclosure where fresh air from outside the enclosure can enter the fan. An unrestricted exhaust opening must be placed somewhere in the wall of the enclosure to let the warm air escape. The size of the exhaust opening must be equal to or larger than the opening for the cooling air inlet. Any restriction of the cooling air entering the heat sink assembly will result in overheating of the PA3 amplifier with possible failure.

The Cooling Fan on the HS2

The fan on the HS2 heat sink is powered by the PA3 circuit board, so there is no need for a separate power supply to operate the fan.

The fan is very quiet and does not make much noise. It is easy to forget that it is running while you are working with your system. Please be careful not to allow your fingers or anything else to come in contact with the fan blades while the fan is in operation. Accidentally hitting the fan blades with your finger or a hard object such as a screwdriver may break one of the blades off of the fan hub. If this happens, it will be necessary to replace the fan.

RF Shielding Considerations to Prevent Interference to Other Devices

If the RF output of the PA3 is taken through a properly installed and terminated coaxial cable, the incidental RF leakage from the PA3 will be minimal and no interference to radios or television receivers should occur due to radiation from the PA3 itself.

The most likely cause of electrical interference to other devices will occur if there is excessive RF radiation from the connecting wires between the plasma tube and the 3.1 MHz link coil coupler / antenna tuner. It is important to minimize the length of these connecting wires. These wires should be equal in length, and spaced as close together as possible consistent with the physical

requirements of the plasma tube. Placing the wires close together helps to cancel unwanted RF radiation from the wires.

In most jurisdictions, it is the responsibility of the operator of any radio frequency producing equipment to prevent the equipment for producing interference to other users of the radio frequency spectrum or other electronic equipment. Please be aware of local regulations before operating this equipment.

Electrically Insulating the STW20NK50Z from the heat sink

This section only applies when it is necessary to replace the output transistor on the PA3.

Because the STW20NK50Z generates a considerable amount of heat in a small package, a high quality thermal pad is required for safe operation of the STW20NK50Z.

The STW20NK50Z is operating at both a high DC voltage and a high RF voltage, therefore it is necessary to insert some form of electrical insulator (thermal pad) between the STW20NK50Z and the heat sink base plate. This insulator must be made of some material which both insulates the high voltage and at the same time it must be a good conductor for heat to allow the heat to flow from the STW20NK50Z to the heat sink base plate. Unfortunately, most materials which are good insulators for electricity are also good insulators for heat. Manufacturers have gone to a great deal of trouble and expense to produce devices, commonly referred to as "thermal pads" which will function properly.

The Bergquist SPA3000-0.015-00-104 thermal pad is recommended for use with the PA3. If this pad is not available, a Wakefield 174-9-250P thermal pad may be substituted. However, the heat transfer capability of the Wakefield pad is approximately 50% of the Bergquist pad. Therefore when using the Wakefield thermal pad, the PA3 should not be operated above 300 Watts output with modulation duty cycles above 70%.

Before attaching the STW20NK50Z and the Bergquist thermal pad to the heat sink, use a liquid cleaning solution, such as 100% isopropyl alcohol and a lint free rag to carefully clean the underside of the STW20NK50Z and the area of the heat sink where the STW20NK50Z is to be mounted. Make sure that both sides of the thermal pad are very clean. Be sure that there are no stray particles of metal, lint, fiber, or other materials on the surface of the transistor, the thermal pad, or the heat sink before mounting the STW20NK50Z to the heat sink.

When installing the thermal pad do NOT use any paste type thermal compound. Using paste type thermal compound will cause decreased heat transfer and may cause damage to the thermal pad and/or destruction of the STW20NK50Z.

Operation of the PA3

POWER SUPPLY

To use the PA3, you will need to use a power supply that provides a DC voltage between +15 to +190 volts, depending on the output power level you require. The higher the voltage, the more power output from the PA3. The current required is approximately 3 amperes maximum. The exact current drawn by the PA3 will depend upon the modulation duty cycle and the plasma tube load to which the PA3 is connected. The current is also affected by the tuning of the antenna tuner or the 3.1 MHz link coil coupler.

When using the PA3 and the LC31 link coupler to drive the Cheb 8 inch Phanotron plasma tube, a power supply voltage of between 100 and 130 V will be required.

When using the PA3 and the LC31 link coupler to drive the Cheb 1" x 16" SSQ-PT plasma tube, a power supply voltage of between 50 and 80 V will be required.

POWER ADJUSTMENT

The power output from the PA3 is adjusted by varying the DC supply voltage connected to the +HV terminal block.

MODULATION SIGNAL VOLTAGE LEVELS

Note that the PA3 amplifier turns ON when the input drive signal goes in the positive direction, and turns OFF when the input drive signal goes in the negative direction. In the absence of any valid input signal, the PA3 will turn OFF.

Operation of the PA3 with a square wave modulation signal

A minimum of 2.25 Volts Peak to Peak (VPP) is required to trigger the PA3. Ideally, the drive signal should be a square wave TTL signal, which has a voltage swing of 0 to +5 Volts.

Modulation Duty Cycle vs. Frequency with a square wave modulation signal

For a duty cycle of 1% to 50%: 1 Hz to 400 KHz

For a duty cycle of 1% to 89%: 2 Hz to 400 KHz

For a duty cycle of 1% to 98%: 3 Hz to 400 KHz

For a duty cycle of 1% to 99%: 4 Hz to 400 KHz

Operation of the PA3 with a sine wave modulation signal

A minimum of 2.5 Volts Peak to Peak (VPP) is required to trigger the PA3 when using sine waves. The maximum allowable sine wave voltage input should be limited to no more than 7.0 Volts peak to peak to prevent possible damage to the input circuit of the PA3. When using sine waves, the duty cycle of the modulated output of the PA3 will be limited to the range of 20% to 58%.

Modulation Duty Cycle percent vs. voltage with a sine wave modulation signal

2.5 VPP for 20% duty cycle (Minimum duty cycle % possible with sine waves)
3.12 VPP for 37% duty cycle (for Maximum Sidebands)
5.0 VPP for 50% duty cycle (for Normal Operation)
5.58 VPP for 58% duty cycle (Clipping of input signal occurs above this level)

The maximum recommended modulation frequency when using the PA3 is 400 KHz. By reducing the high voltage DC applied to the amplifier stage of the PA3 by at least 25%, modulation frequencies of up to 650 KHz or higher may be utilized at reduced output power.

Note that there is a risk of destroying the STW20NK50D at high modulation frequencies and high power levels.

Although the modulator circuits of the PA3 will work up to 6 MHz, when the modulation frequency exceeds 1/2 of the carrier frequency of 3.10 MHz, or 1.55 MHz, the resulting modulation sidebands “turn over,” and begin dropping in frequency as the modulating frequency begins to approach the carrier frequency. Thus there is no point in using a modulation frequency exceeding 1.55 MHz.

CAUTION: When the modulation frequency begins to exceed about 400 KHz, excessive RF voltages will be developed in the PA3’s tank circuit and the LC31 coupler. These voltages may cause the STW20NK50Z MOSFET in the PA3 to fail.

Operating conditions for the PA3 when used with Cheb Plasma Tubes

Cheb 5-inch Phanotron tube - With modulation frequencies from 0 to 400,000 Hz, the maximum DC supply voltage to the PA3 should be limited to 100 volts to avoid damage to the Phanotron tube. This will result in an approximate power of about 75 watts average power or 150 watts peak power.

Cheb 8-inch Phanotron tube - With modulation frequencies from 0 to 400,000 Hz, the maximum DC supply voltage to the PA3 should be limited to 115 volts to avoid damage to the Phanotron tube. This will result in an approximate power of about 125 watts average power or 250 watts peak power.

Cheb SSQ-ST - With modulation frequencies from 0 to 40,000 Hz, the maximum DC supply voltage to the PA3 should be limited to 152 volts to avoid damage to the SSQ-ST or the PA3. This will result in an approximate power of about 175 watts average power or 350 watts peak power. Using DC voltages in excess of this value may cause the STW20NK50Z MOSFET in the PA3 to fail.

Cheb SSQ-ST - With modulation frequencies from 40,000 to 400,000 Hz, the maximum DC supply voltage to the PA3 should be limited to 133 volts to avoid damage to the PA3. This will result in an approximate power of about 135 watts average power / 270 watts peak power. Using DC voltages in excess of this value may cause the STW20NK50Z MOSFET in the PA3 to fail.

Cheb SSQ-BAT - With modulation frequencies from 0 to 40,000 Hz, the maximum DC supply voltage to the PA3 should be limited to 190 volts to avoid damage to the PA3 amplifier. This will result in an approximate power output to the tube of about 250 watts average power / 500 watts peak power. Using DC voltages in excess of this value may cause the STW20NK50Z MOSFET to fail.

Cheb SSQ-BAT - With modulation frequencies from 40,000 to 400,000 Hz, the maximum DC supply voltage to the PA3 should be limited to 170 volts to avoid damage to the PA3 amplifier. This will result in an approximate power output to the tube of about 250 watts average power / 500 watts peak power. Using DC voltages in excess of this value may cause the STW20NK50Z MOSFET to fail.

Using the PA3 with the UDB1108S signal generator

Note: If the PA3 is connected to the TTL connector on the rear panel of the UDB1108S generator, then the UDB1108S must be set to SQR or the duty cycle adjustment will not change the duty cycle of the square wave coming from the TTL connector of the UDB1108S generator.

When using SQUARE WAVES

- Connect the TTL jack on the rear of the UDB1108S to the input of the PA3.
- Set the UDB1108S for SQR wave output
- The OFFSET knob has no function.
- The AMPLITUDE knob has no function.
- Set the output frequency from the UDB1108S in the usual manner.
- Use the ADJUST knob to set the duty cycle to the desired value.

If you are using a computer program to run the UDB1108S, these functions should be handled automatically, according to the computer program instructions.

When using SINE WAVES

- Connect the OUT jack to the input of the PA3.
- Set the UDB1108S for SIN wave output.
- Set the OFFSET knob to center position (Zero volts DC offset.)
- NOTE: If the OFFSET knob is adjusted fully clockwise, then the maximum possible duty cycle available when using sine waves will be increased to a maximum of 70%.
- Set the AMPLITUDE knob for the desired duty cycle.

Using the PA3 with the GB-4000 (in Audio Mode only)

- Connect a coaxial cable between the BNC coaxial jack on the rear of the GB-4000 to the input connector of the PA3.
- Set the GB-4000 to AUDIO MODE – do not use RF MODE.
- Set the OUTPUT LEVEL control knob to the 12:00 o'clock position.
- Adjust the DUTY CYCLE of the GB-4000 as desired.
- Run all frequencies and auto channels on the GB-4000 just as you would when using the GB-4000 with the MOPA.

RF Coupling Systems

The LC31P or the LC31S 3.1 MHz Link Coupler System

Using the LC31 coupler eliminates most of the RF losses of the antenna tuner and gives the RF signal at the plasma tube a sharper rise and fall time, resulting in a better, brighter plasma discharge and a more effective frequency output.

Using the LC31 coupler is simple. Simply connect a 23-foot length of solid dielectric 50 ohm coaxial cable between the output of the PA3 amplifier, and the input to the LC31 coupler. Connect the appropriate length of wire between the output of the LC31 coupler and the plasma tube. Then turn on the power. There are no tuning adjustments required.

Please see the LC31 instruction manual for more information on using the LC31 3.1 MHz link coil coupler with various plasma tubes.

Commercial Antenna Tuners

The use of commercial antenna tuners with the PA3 is strongly discouraged. The PA3 was designed to work best with the LC31 link coil coupler. While it is possible to use a commercial antenna tuner with the PA3, because of the large number of tuners available, it is impossible to give specific instructions for using each tuner.

It is strongly suggested that you use the type LC31 link coil coupler.

Tuning Waveforms if you are using a commercial antenna tuner or you have built your own matching system

If you have an oscilloscope available, then the best way to tune the matching circuit between the PA3 and the plasma tube is to observe the waveform at the RF output terminals of the PA3.

Please be careful what taking these measurements!

When operating at high power levels, the voltage existing at the drain terminal of the STW20NK50Z may exceed 500 Volts RF along with a steady DC voltage of up to 190 V. This high RF voltage also exists at the output terminals of the PA3.

The following pictures show the RF waveforms at the RF output of the PA3. They are taken at the RF OUT terminal block. For these pictures, the PA3 was connected to a 50 ohm dummy load.

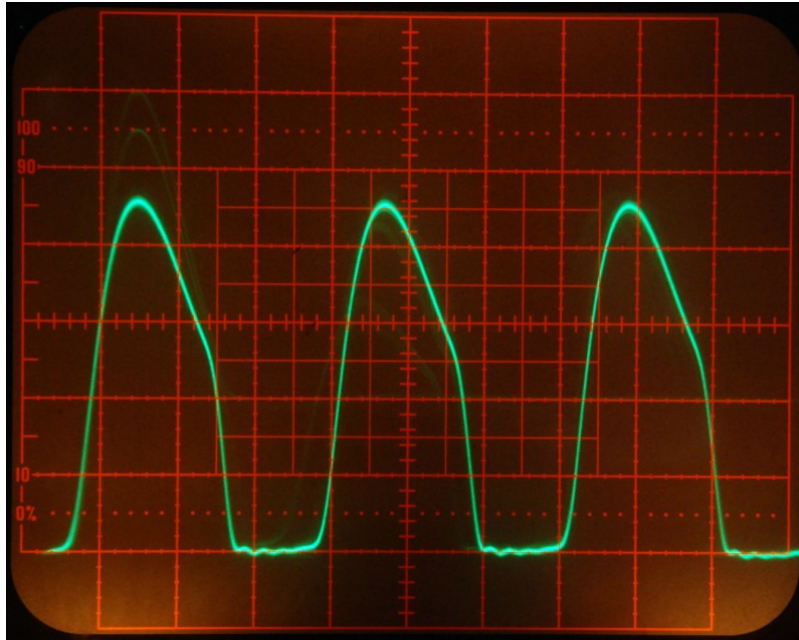

Figure 2

PA3 output waveform across a 50 ohm load.

This is also what the waveform looks like when the PA3 is properly tuned and connected to a plasma tube. Note that the upper part of the right-hand side of the waveform slopes slightly to the left. This is correct, and indicates the proper amount of tuning capacitance in the coupling system. If the waveform slopes to the right, then the tuning capacitance is too low. It is better to operate with too much capacitance, then too little.

CAUTION!

Operating the PA3 at high power levels when the system is tuned with too low a value of tuning capacitance will result in the STW20NK50Z drawing excessive drain current. This may cause the STW20NK50Z to fail due to overheating.

Operating the PA3 a high power levels with the system is tuned with too large a value of tuning capacitance will result in the drain voltage of the STW20NK50Z rising to excessively high levels. This may cause the STW20NK50Z to fail due to over voltage.

The next two pictures show what the waveform looks like when the coupling system has too low a value of tuning capacitance.

CAUTION!

Operating the PA3 at high power in this tuning condition may destroy the STW20NK50Z.



Figure 3

This photograph shows the waveform from the PA3 when the tuning capacitor of the matching system is too low. In other words, the system is tuned too high in frequency. **Operating the PA3 at high power in this tuning condition may destroy the STW20NK50Z.**

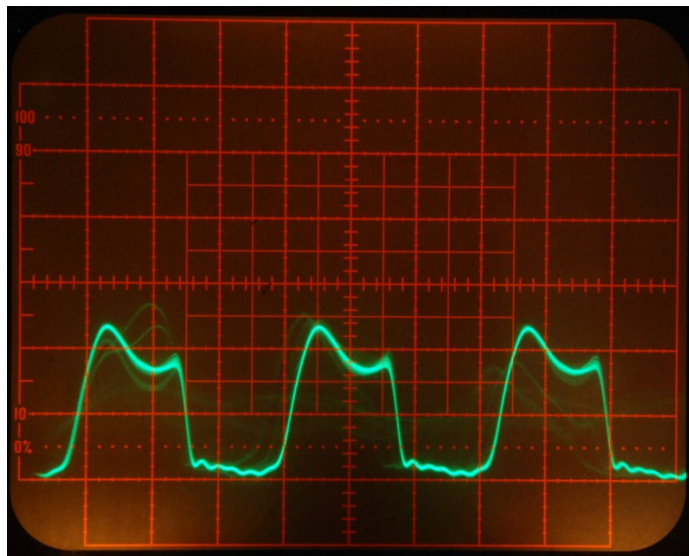

Figure 4

This photograph shows waveform from the PA3 when the tuning capacitor of the matching system is too low. In this case, the system is much closer to resonance, but it is still tuned too high in frequency. Additional tuning capacity must be added or the STW20NK50Z may fail during high power operation. **Operating the PA3 at high power in this tuning condition may destroy the STW20NK50Z.**

Replacing the STW20NK50Z on the PA3

Although the STW20NK50Z MOSFET that is used in the PA3 is a very rugged device, it is still possible for it to fail if the PA3 is operated under an excessive load or under improper operating conditions. Should this happen, it will be necessary to replace the STW20NK50Z MOSFET. This is not particularly difficult to do. Please read the following sequence of operations before attempting to replace the transistor.

1 – Using a small flat-blade screwdriver, carefully loosen the three clamping screws in the terminal strip that fastens the leads of the STW20NK50Z MOSFET in place.

2 – Remove the two 6-32 x 3/8” Phillips head screws and nuts that hold the PA3 to aluminum mounting bars that are attached to the heat sink. Place the screws and nuts where they will not become lost.

3 – Carefully remove the PA3 from the heat sink assembly.

4 – Using a Phillips head or a flat-blade screwdriver, unscrew the 6-32 x 3/4” screw and flat washer that clamps the STW20NK50Z MOSFET against the heat sink. Place the screw and flat washer where they will not become lost.

5 – Carefully remove the defective STW20NK50Z MOSFET from the heat sink.

Because the MOSFET will be probably stick to the Bergquist thermal pad that is between the MOSFET and the heat sink, you may have to use a pair of pliers to carefully pull the defective MOSFET away from the thermal pad. Gently, but firmly, grasp the sides of the defective MOSFET with the pliers and “rock” the MOSFET from side to side until it breaks free of the thermal pad. Be sure not to damage the thermal pad. It is very soft, and scratches or punctures easily. If it is damaged in any way, it will be necessary to replace it with a new thermal pad of the same type before installing the new MOSFET against the heat sink.

6 – Take the new STW20NK50Z MOSFET and carefully bend its leads into the same shape as the leads of the defective MOSFET.

Do not bend them too sharply or they may weaken and break off at the bend.

7 – Carefully trim approximately 1.5 mm from the end of the pins of the MOSFET. Be careful not to remove too much of the pin length.

8 – Using a small piece of lint free cloth and 100% isopropyl alcohol, gently clean the surface of the Bergquist thermal pad and the metal surface of the STW20NK50Z MOSFET that will mount against the thermal pad.

9 – Carefully position the replacement MOSFET against the surface of the thermal pad, and press it firmly against the thermal pad.

10 – Using the 6-32 screw and the flat washer, clamp the new MOSFET firmly against the Bergquist thermal pad and heat sink. Do not allow the MOSFET and the thermal pad to twist sideways while tightening the screw.

Although it may seem that the length of the 6-32 screw is a longer than it needs to be, it is necessary to use a long screw in order to spread the clamping force across a number of screw threads that are tapped in the heat sink. The screw must be tightened very firmly against the transistor. The flat washer must be used to spread the clamping force over the transistor body and prevent cracking of the transistor case.

11 – Carefully position the PA3 circuit board so that the leads of the new STW20NK50Z enter the holes of the mounting block on the PA3. Be sure that you do not bend the leads of the STW20NK50Z in the process.

12 - When you observe that the leads have entered the mounting block correctly, then you may replace the two Phillips head screws and nuts that clamp the PA3 circuit board to the aluminum mounting bars that are attached to the heat sink.

13 – Gently, but firmly, tighten the three clamp screws that hold the leads of the STW20NK50Z to the PA3 circuit board. ***Do not omit this step or the MOSFET may be destroyed during operation!***

14 – Inspect your work to make sure that there are no short circuits, metal particles, or anything else that might interfere with the proper operation of the PA3. If all is correct, you may replace the heat sink assembly and the PA3 in your system and resume normal operation.

SPECIFICATIONS:

DC Power Supply Input:

- For the Power Amplifier: +15 to +190 volts DC at a maximum current of 3.0 amperes; nominal operating current less than 2.1 amperes, depending on output power level and modulation duty cycle.
- For the Signal Processor and heat sink fan: +18 to +22 volts DC at a maximum current of 750 mA at a 100% duty cycle modulation rate.

Input Impedance:

- Approximately 5000 Ohms, AC coupled.

Input Drive Signal Requirements:

- TTL level (0 to +5 volts) duty cycle modulated square wave from an external frequency generator.
- Modulation frequency range with square wave input: 4 Hz to 400,000 Hz for a duty cycle range of 1% to 100%
- Sine wave of 2.5 to 7.0 volts peak-to-peak. The voltage level of the sine wave adjusts the duty cycle of the PA3 output.
- Modulation frequency range with square wave input: 4 Hz to 400,000 Hz for a duty cycle range of 1% to 100%
- The modulation input of the PA3 is AC coupled, so it will ignore any DC offset voltage on the modulation input signal, however any DC offset voltage must be limited to a maximum of +/- 10 volts.

Carrier Operating Frequency:

- 2.9 to 3.5 MHz. Operation outside of this frequency range may cause damage to the PA3. The suggested operating frequency is 3.1 or 3.3 MHz. The PA3 is furnished with a 3.10 MHz oscillator, but customer selected frequencies may be specified at the time of order.
- The carrier frequency of the PA3 may be quickly changed by plugging in a different frequency oscillator module.

RF Power Output:

- Up to 500 watts peak power or 250 watts average power into a 50 ohm dummy load when the carrier is modulated by a 50% duty cycle square wave with frequencies from 1 to 400,000 Hz.
- When the PA3 is operated at a peak power level of 300 watts or less, the PA3 may be operated at any duty cycle between 0 to 100%.
- The power output of the PA3 may be adjusted by varying the DC voltage supplied to the PA3.
- To avoid possible damage to the PA3, when driving plasma tubes with modulation frequencies above 40 KHz, the DC power supply voltage to the PA3 should be limited to the maximum values as shown in the data below.

Warranty

All our products carry a one (1) year warranty against manufacturing defects. Mechanical damage is not covered; i.e., you dropped it on the floor and then accidentally stepped on it. For warranty claims, you pay shipping to us; we pay shipping back to you.

Kits assembled by the purchaser are also have a one (1) year against component failure. Breakage or overheating damage from soldering of components during assembly is not covered under warranty.

Damage to the STW20NK50Z MOSFET transistor due to over voltage operation or inadequate cooling is not covered under warranty.

For all warranty claims or equipment service, please contact us by email or telephone before returning equipment for service.

Out-of-Warranty repair service is at the rate of \$20/hour, with a maximum charge of \$50 per item, unless otherwise specified. Please contact us for additional pricing on custom repair services.

Contact us

Ralph Hartwell

Spectrotek Services

641 Sisson Road
Natchitoches, LA
71457-6743
USA

318-527-6766

ralph@spectrotek.com

<http://rife-beam-ray.com>

<http://rifebeamray.com>

<http://w5jgv.com/rife>

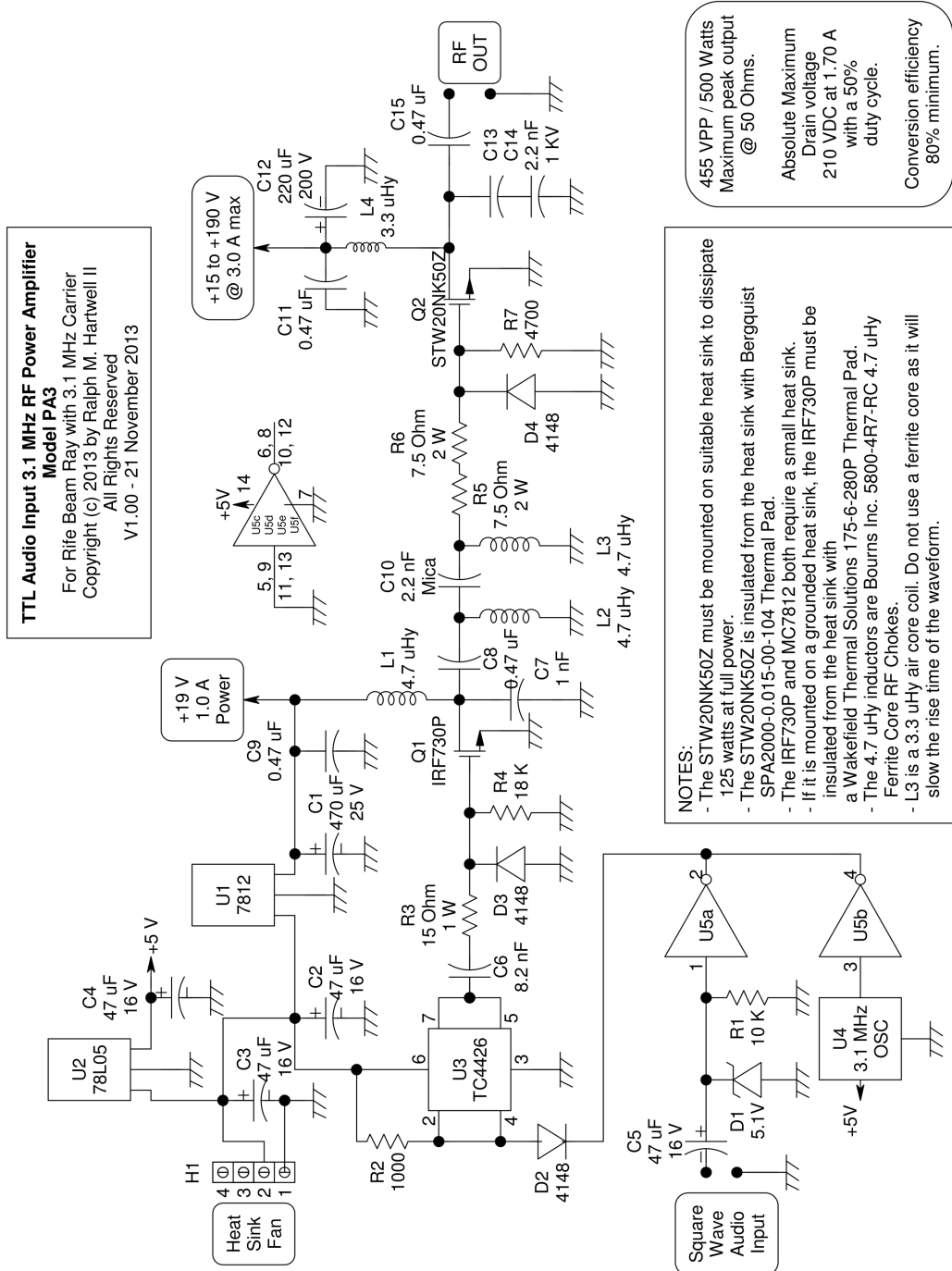

Figure 5

Schematic Diagram of the PA3 v1.00.

PA3 Output Waveforms at various modulation frequencies

To obtain the following waveforms, the PA3 was connected to a 50 ohm dummy load.

The PA3 was driven by a UDB1108S signal generator set to the square wave mode.

The output power level of the PA3 was 200 watts peak RF power to the dummy load.

The upper (red) trace is the output of the PA3, and the lower (yellow) trace is the input signal from the UDB1108S signal generator.

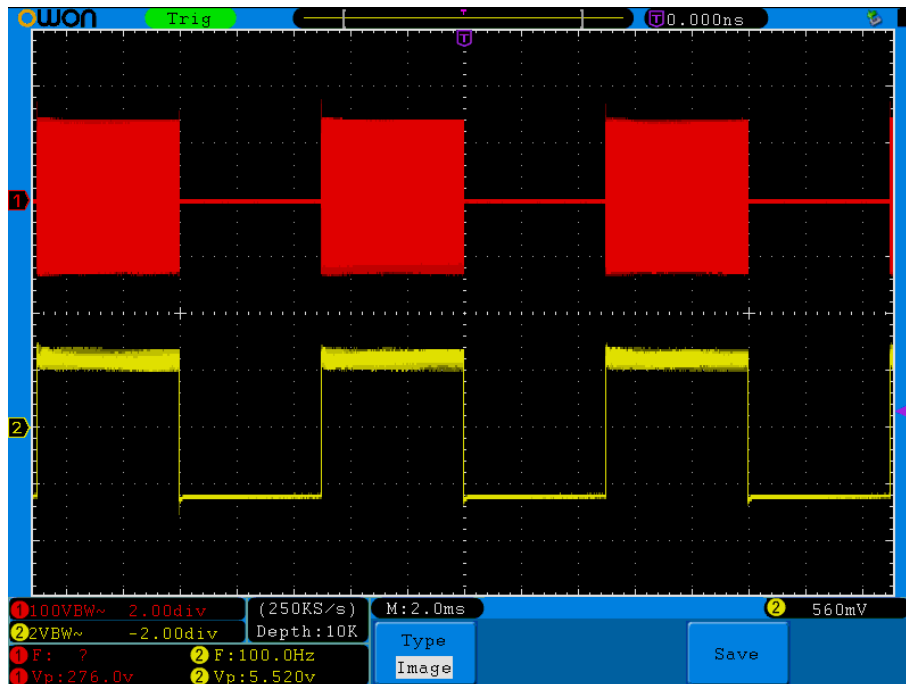

Figure 6 - 100 Hz, 50% duty cycle.

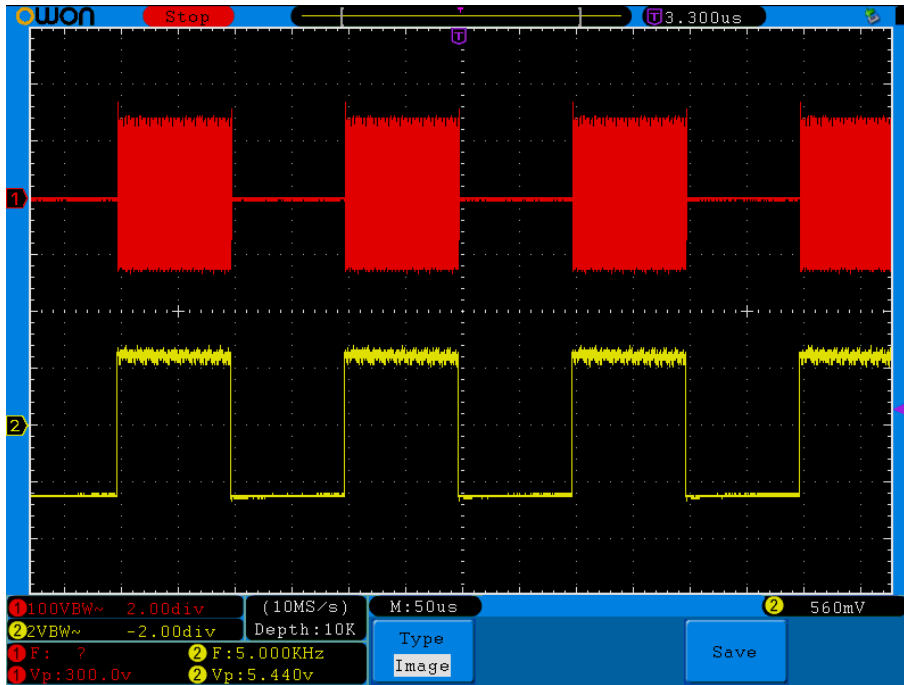

Figure 7 – 1,000 Hz, 50% duty cycle.

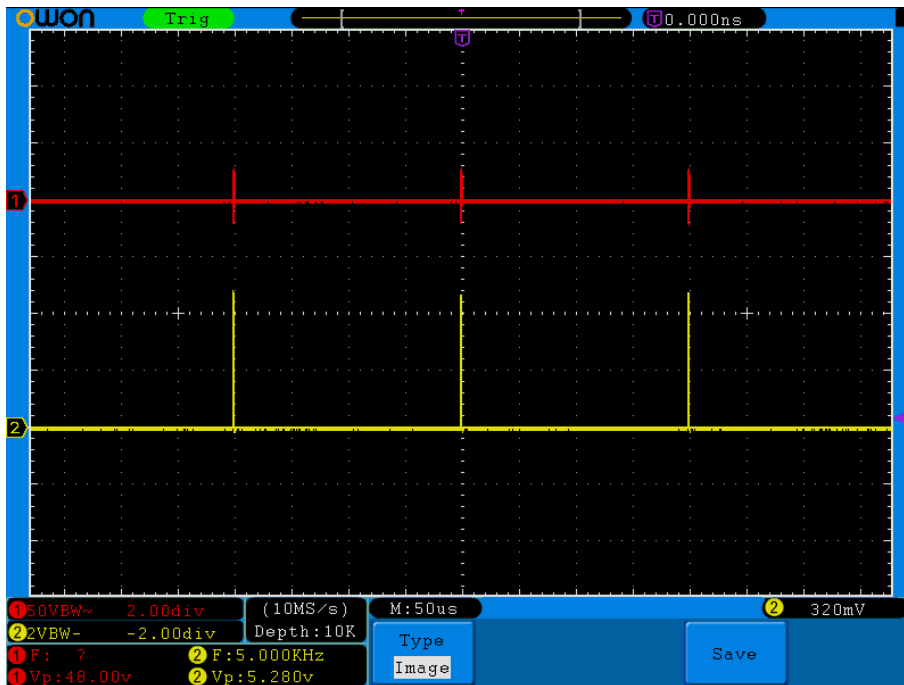

Figure 8 – 5,000 Hz, 1% duty cycle.

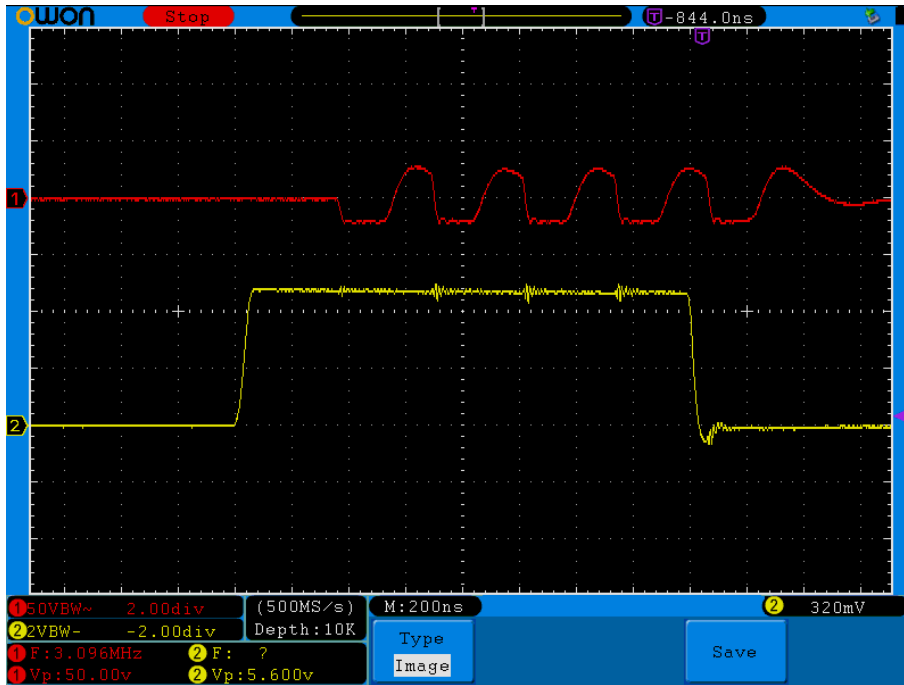

Figure 9 - 5,000 Hz, 1% duty cycle, expanded scale, showing individual RF cycles.

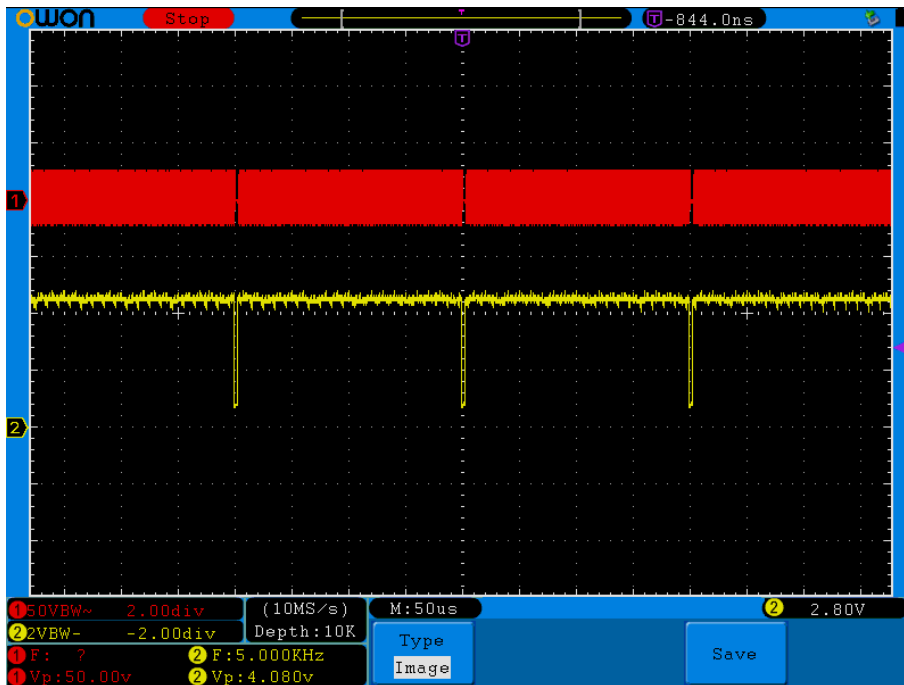

Figure 10 - 5,000 Hz, 99% duty cycle.

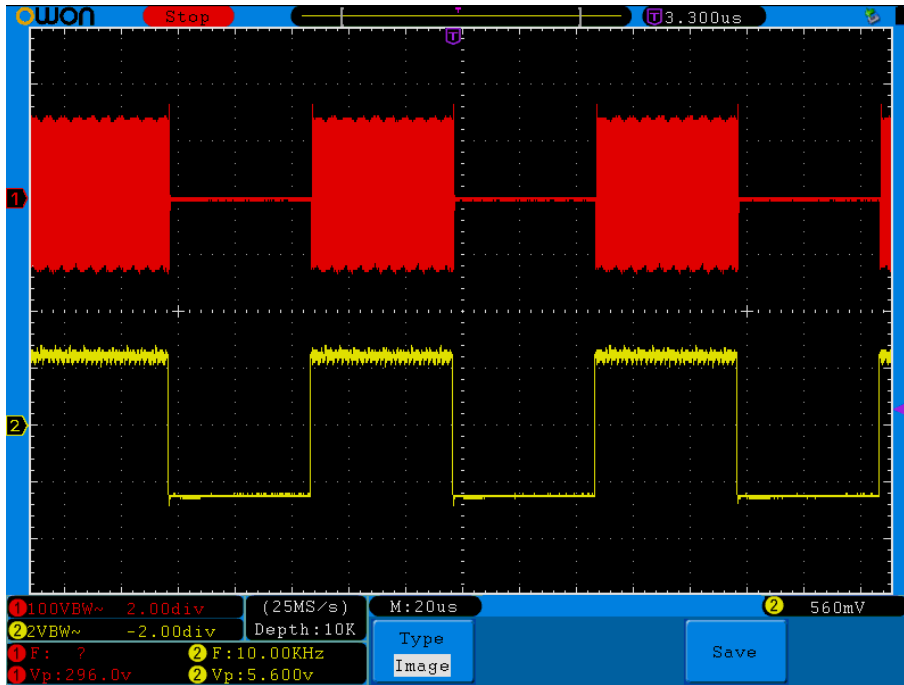

Figure 11 – 10,000 Hz, 50% duty cycle.

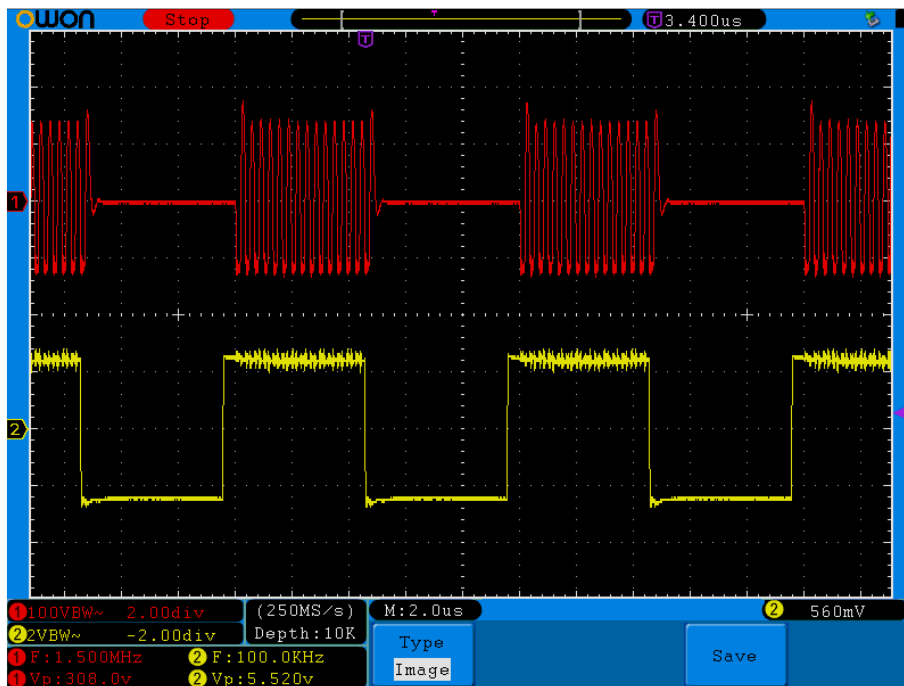

Figure 12 – 100,000 Hz, 50% duty cycle.

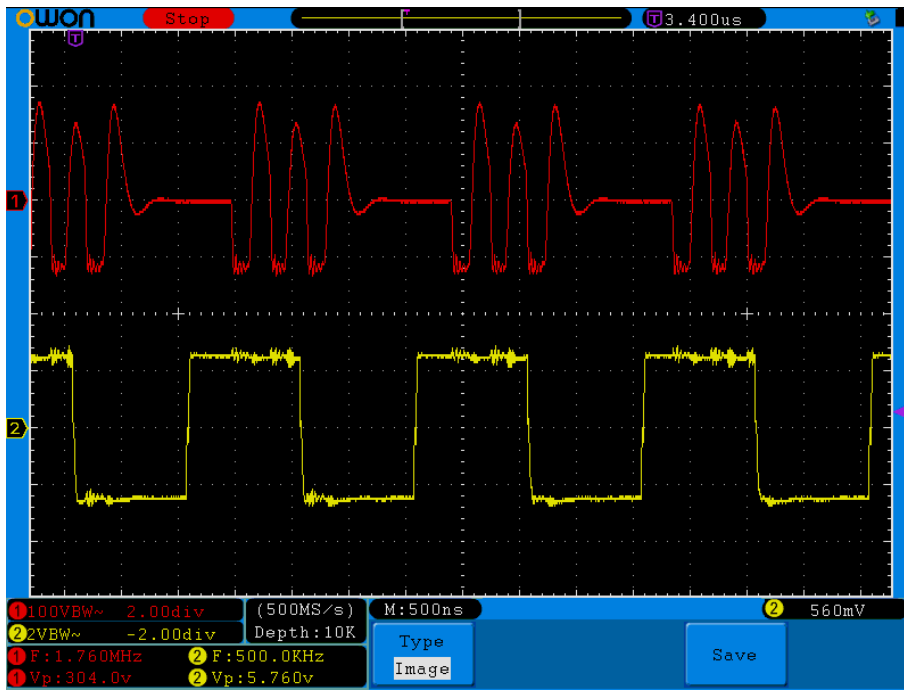

Figure 13 – 500,000 Hz, 50% duty cycle.

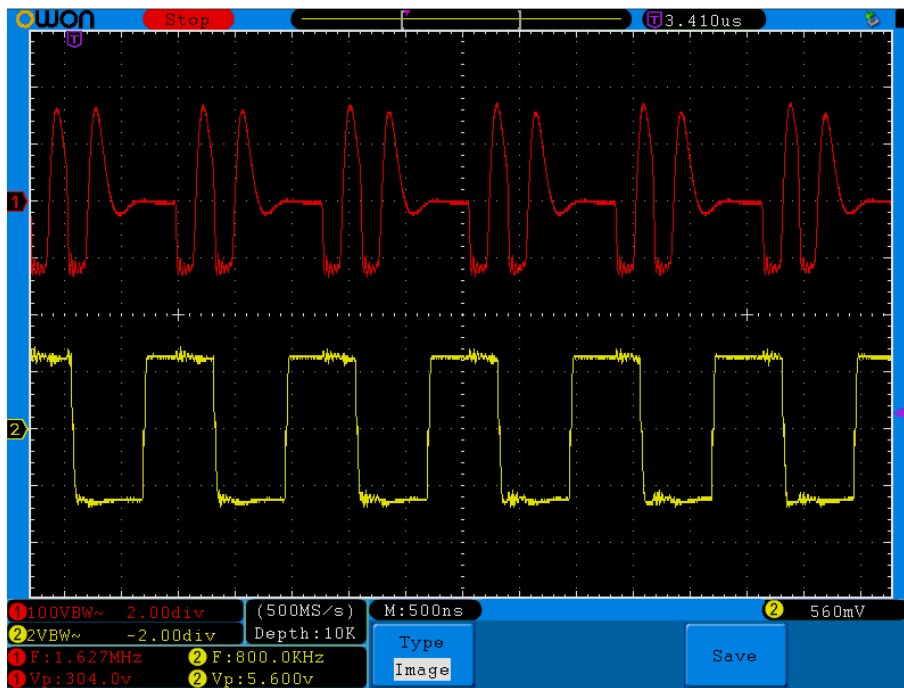

Figure 14 – 800,000 Hz, 50% duty cycle.



Edited by CAT