

DRIVEN BY CAM FROM TURRET

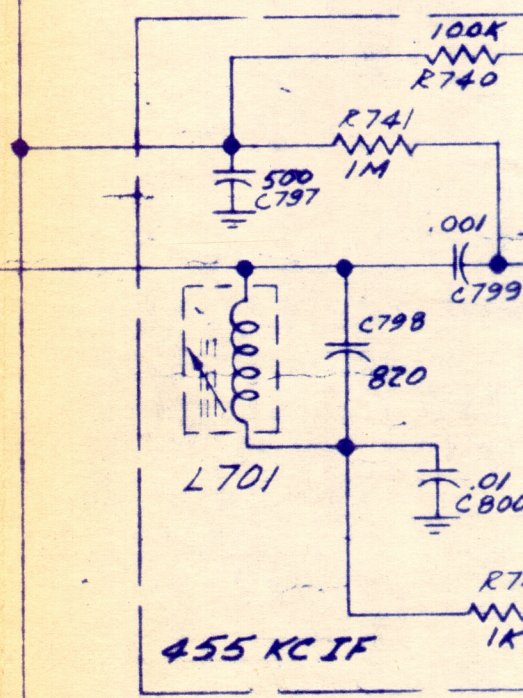

GAIN

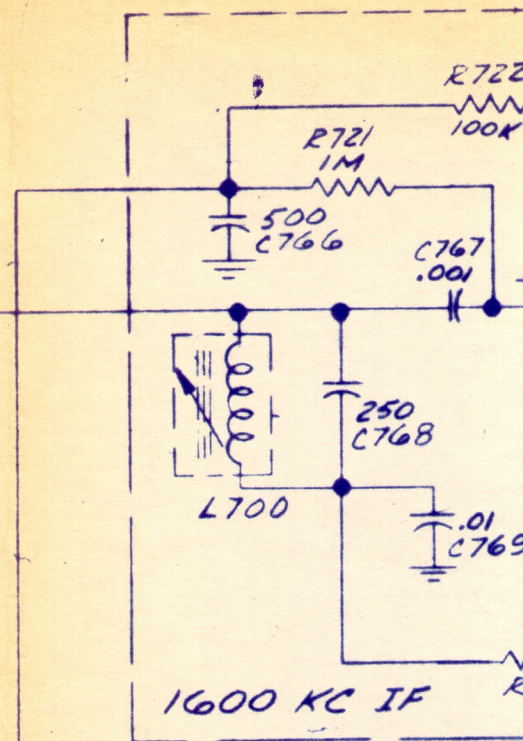

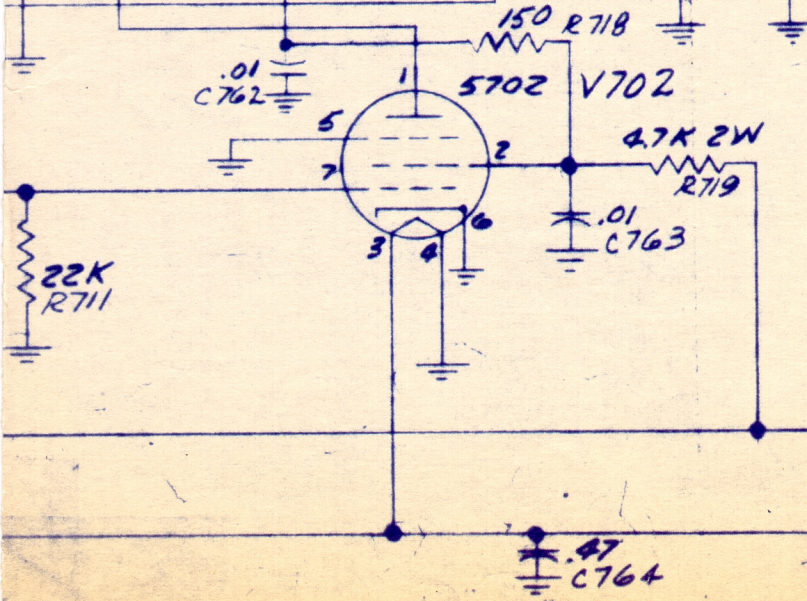
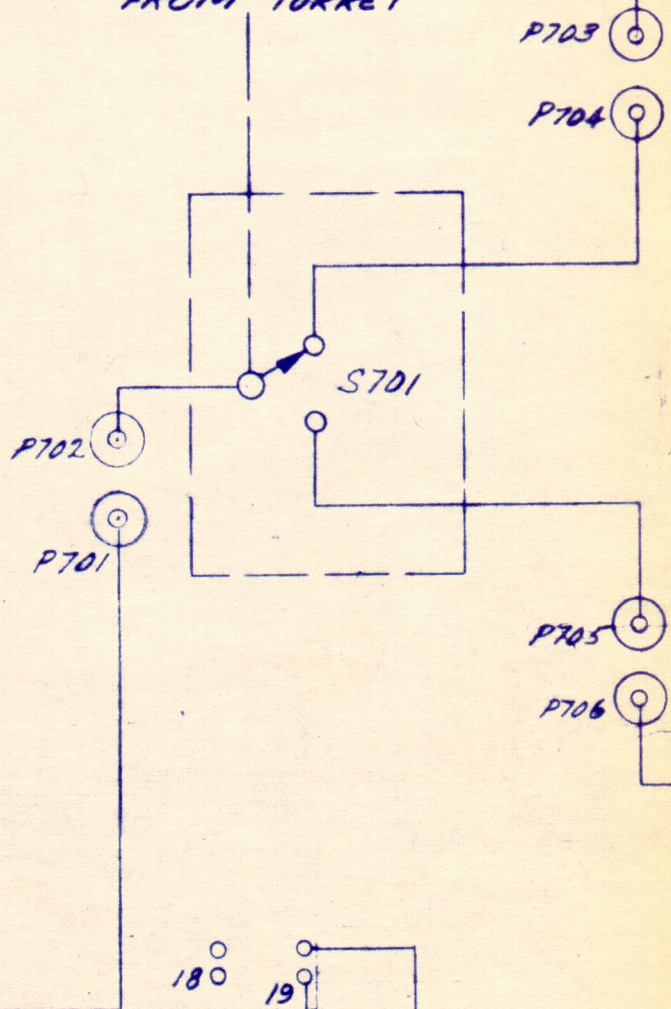
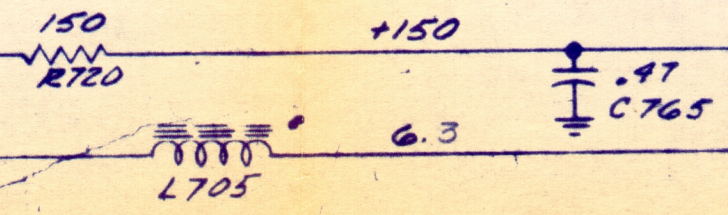
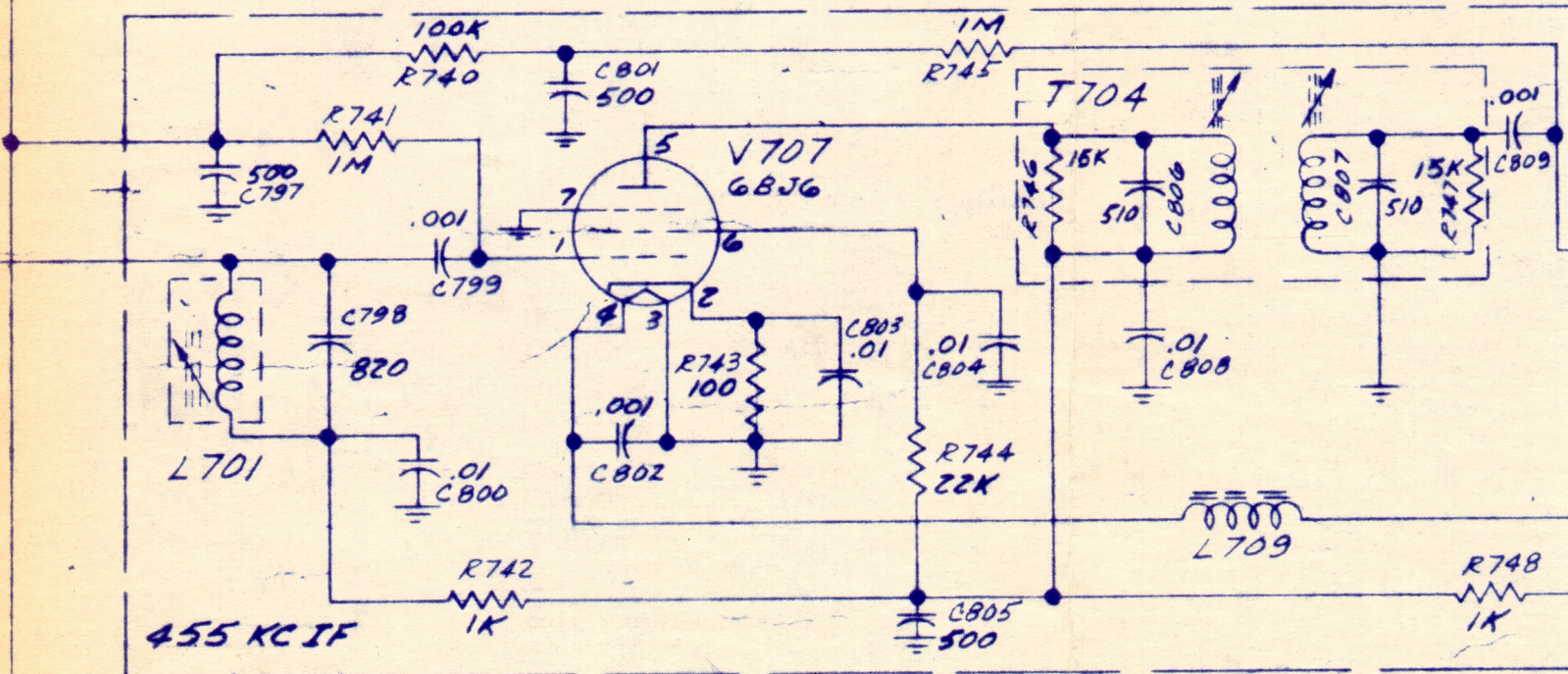
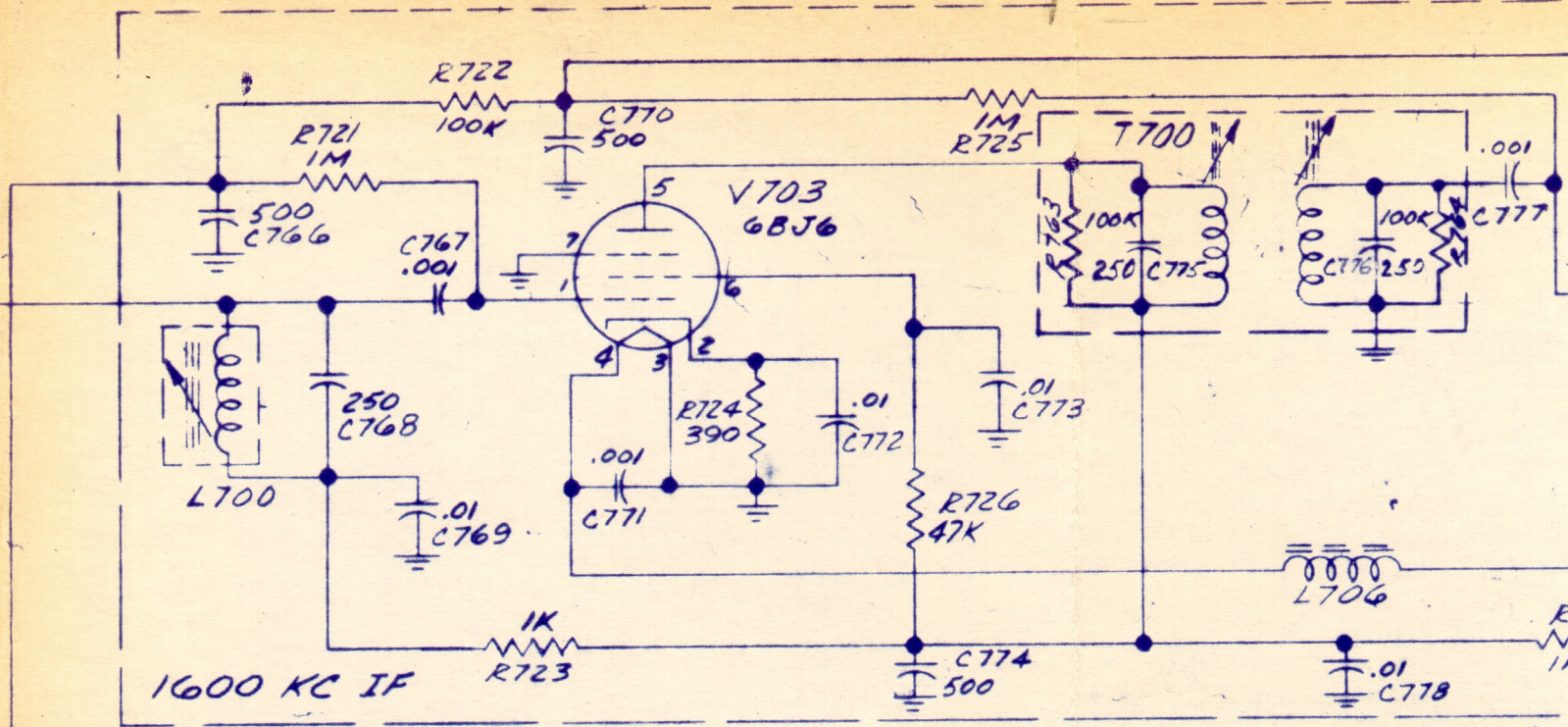

GAIN

+150

6.3

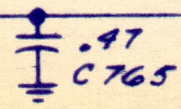

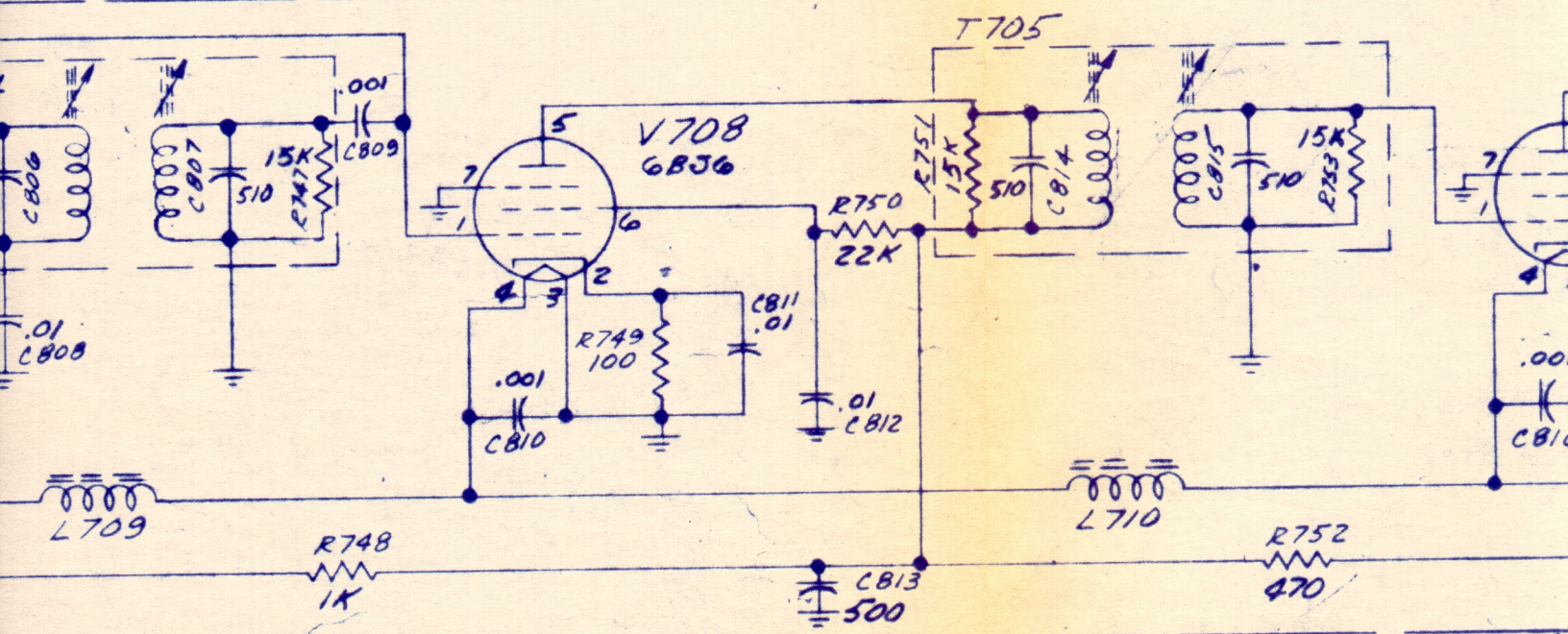
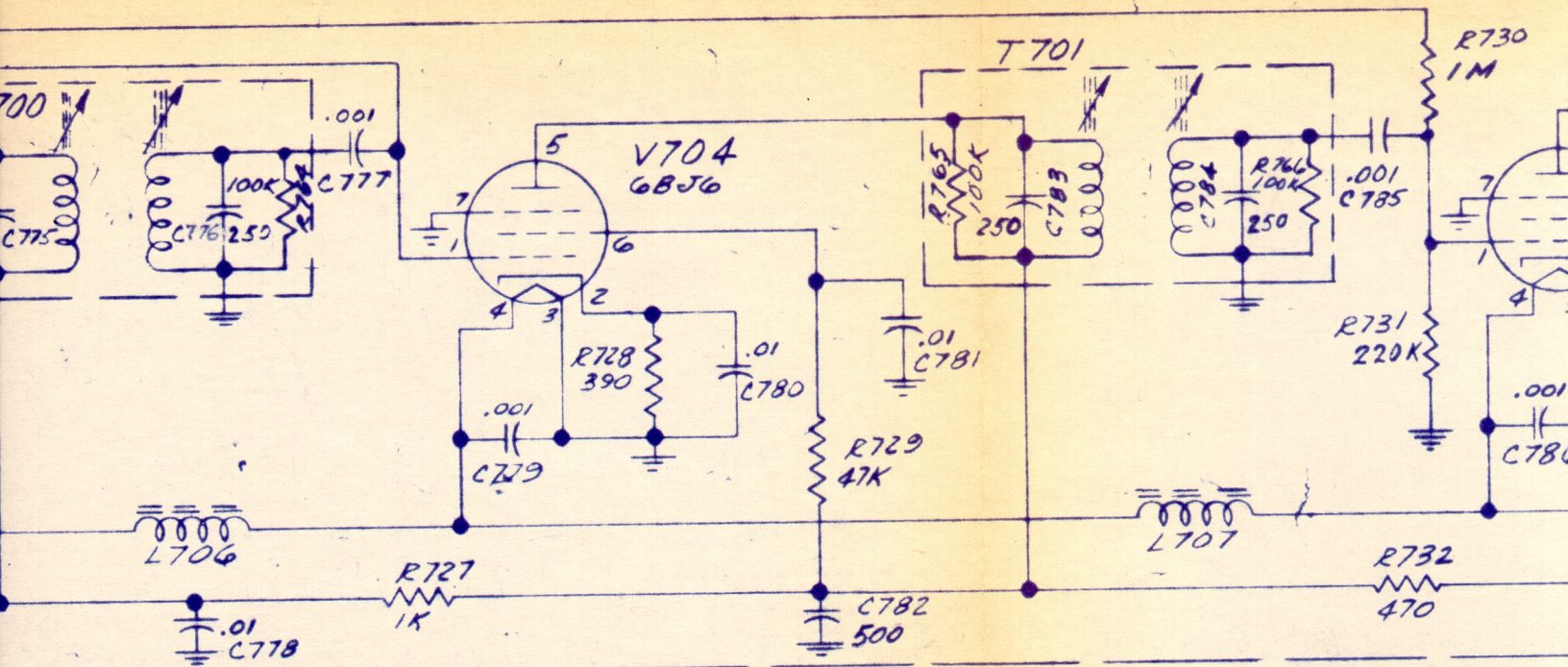

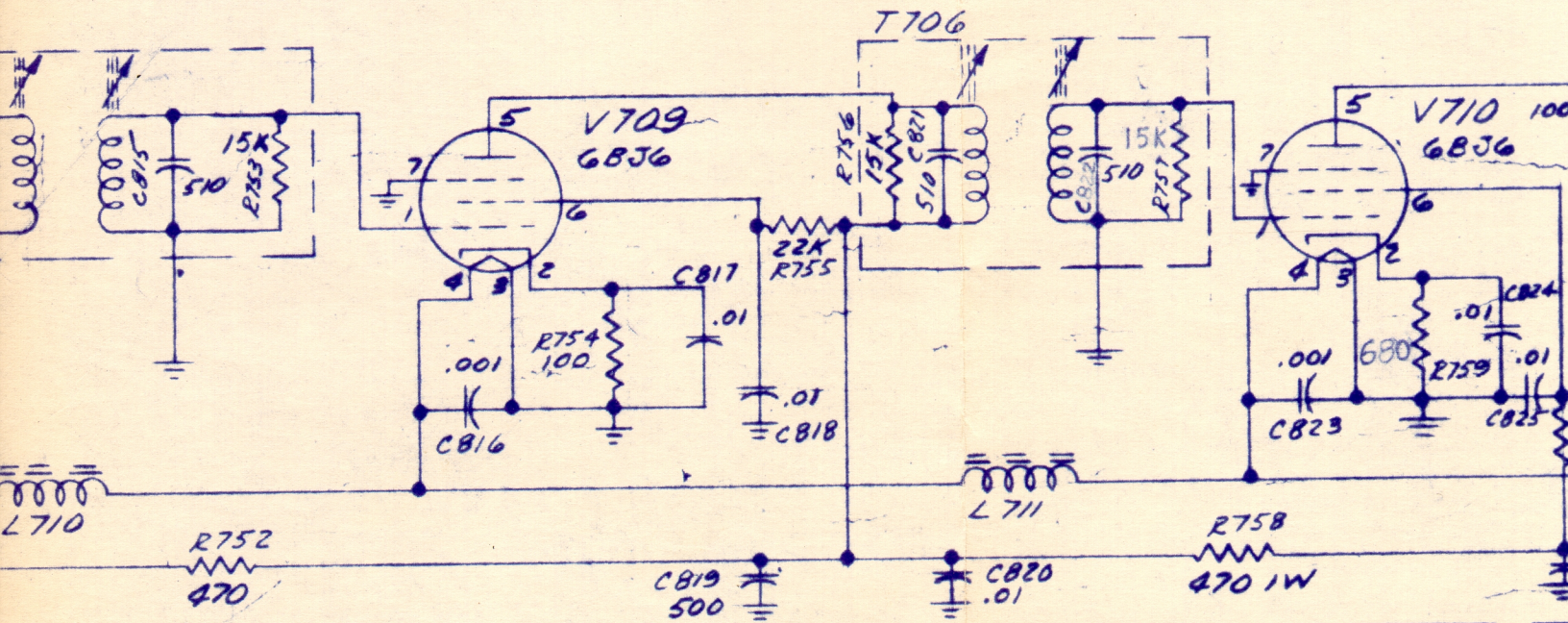
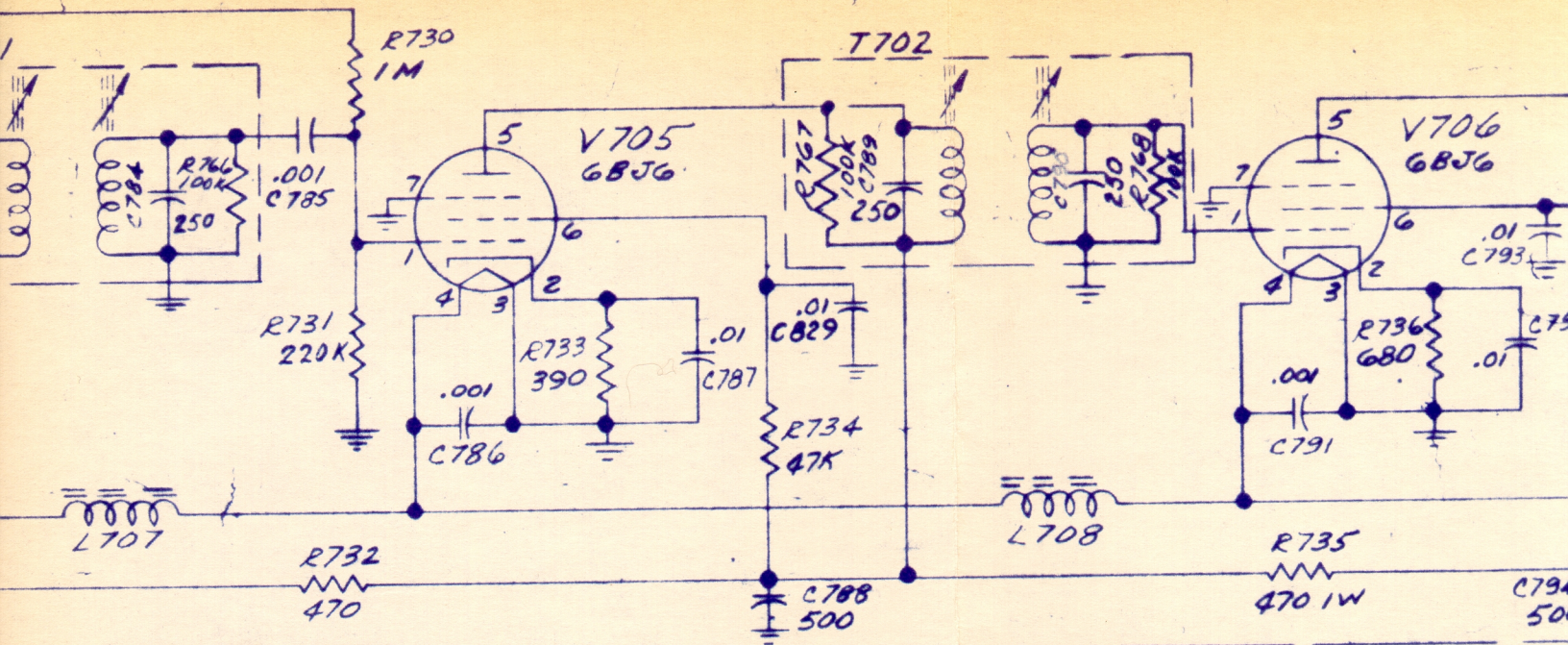

WAFER SWITCH
ON TURRET SHAFT

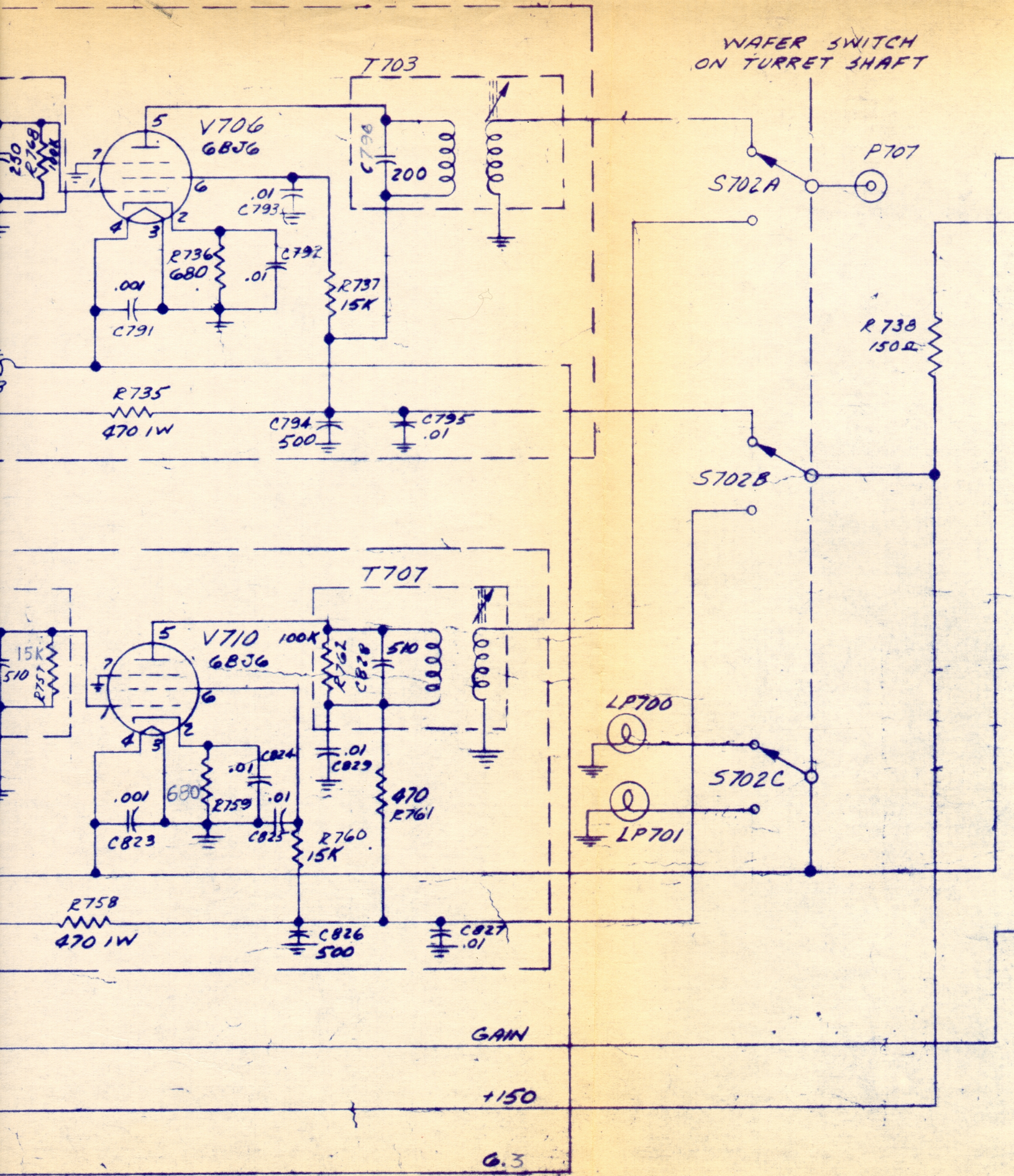

GAIN

+150

6.3

SWITCH
T SHAFT

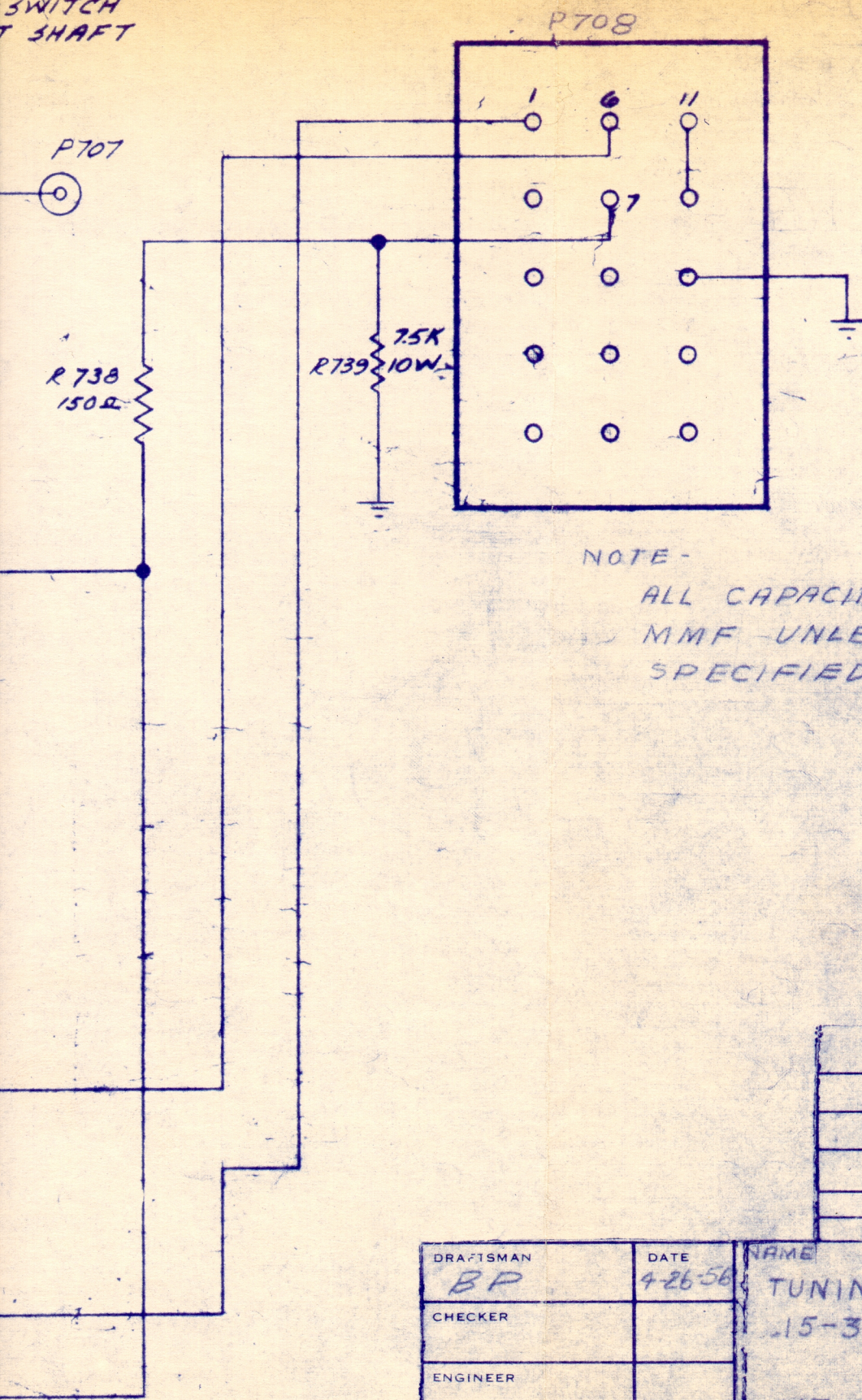

NOTE -

ALL CAPACITOR VALUES IN
MMF - UNLESS OTHERWISE
SPECIFIED,

	TA-NF-105		
NEXT ASSY	USED ON	NEXT ASSY	
APPLICATION		QUANTITY	

DRAFTSMAN BP	DATE 4-26-56
CHECKER	
ENGINEER	
EXAMINED	
PROD. APPD	

NAME TUNING UNIT .15-30 MC NF-105
--

EMPIRE DEVICE INC. Amsterdam, New York	
DWG SIZE R	4371
DRAWING NO	