

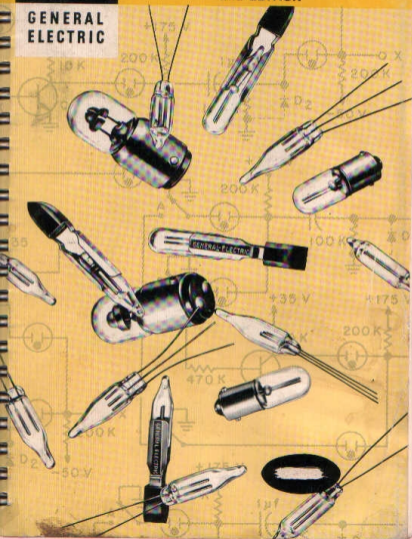

GLOW LAMP MANUAL

THEORY — CIRCUITS — RATINGS
2nd EDITION

GENERAL
ELECTRIC



GENERAL ELECTRIC GLOW LAMP MANUAL

Second Edition
(Second Printing)

PHOTO CELL
USE

SEE

PAGE 107

73,74

Contributors

C. R. Dougherty
T. E. Foulke
J. D. Harnden
T. L. Hewitt
F. N. Peters
R. D. Smith
J. W. Tuttle

Edited By

Miniature Lamp Department
Product Planning and Application
General Electric Company
Nela Park, East Cleveland 12, Ohio

The circuit diagrams included in this manual are included for illustration of typical glow lamp applications and are not intended as constructual information. Although reasonable care has been taken in their preparation to insure their technical correctness, no responsibility is assumed by the General Electric Company for any consequences of their use.

The glow lamp devices and arrangements disclosed herein may be covered by Patents of General Electric Company or others. Neither the disclosure of any information herein nor the sale of glow lamp devices by General Electric Company conveys any license under patent claims covering combinations of glow lamp devices with other devices or elements. In the absence of an express written agreement to the contrary, General Electric Company assumes no liability for patent infringement arising out of any use of the glow lamp devices with other devices or elements by any purchaser of glow lamp devices or by others.

Copyright 1966

by

General Electric Company

| | |
|---|-----|
| 1. PHYSICS AND CHARACTERISTICS OF GLOW LAMPS | 1 |
| Theory of Gaseous Conduction in the Glow Lamp | 1 |
| Glow Lamp Characteristics | 3 |
| General | 3 |
| Response Time | 3 |
| External Effects | 5 |
| Equivalent Circuits and General Formulae | 7 |
| Rated Life and Aging | 8 |
| Light Output | 10 |
| 2. RELAXATION OSCILLATORS | 14 |
| Glow Lamp Sawtooth Oscillator | 14 |
| Basic Sawtooth Oscillator Operation | 14 |
| Conditions Necessary for Sustained Oscillations | 17 |
| Design of Glow Lamp Sawtooth Oscillators | 19 |
| Operating Characteristics of Sawtooth Oscillators | 24 |
| Operating Environment of Lamps | 29 |
| Glow Lamp Astable Multivibrator | 29 |
| Applications | 34 |
| The Electronic Organ | 34 |
| Variable Frequency-Variable Pulse Width Generator | 36 |
| Time Delay Relays | 37 |
| Alarm Circuit | 39 |
| Light Indicator | 39 |
| Temperature Indicator | 40 |
| 3. LOGIC AND COMPUTER APPLICATIONS OF GLOW LAMPS | 41 |
| The Binary Number System and Logic Operations | 41 |
| The Binary Number System | 41 |
| Fundamental Logic Operations | 42 |
| Logic Circuits Employing Glow Lamps | 45 |
| Glow Lamp AND Gate | 45 |
| Glow Lamp OR Gate | 49 |
| NOT Circuits | 52 |
| Designing Glow Lamp Logic Circuits | 52 |
| Computer and Counting Circuits | 57 |
| Timing Generators | 57 |
| Bistable and Monostable Multivibrators | 58 |
| A Glow Lamp Ring Counter | 62 |
| Memory Circuits | 64 |
| 4. GENERAL GLOW LAMP APPLICATIONS | 67 |
| Voltage Regulators | 67 |
| Voltage Level Detectors | 70 |
| Coupling Networks | 71 |
| The Glow Lamp and Photoconductive Devices | 73 |
| Photoconductive Cells | 73 |
| Miscellaneous Applications | 74 |
| 5. GLOW LAMP TEST METHODS | 76 |
| Test Circuits | 76 |
| Conditions for Lamp Measurements | 79 |
| Measuring the Delay Times of Glow Lamps | 80 |
| 6. GENERAL ELECTRIC GLOW LAMP SPECIFICATIONS | 87 |
| General Electric Miniature Lamp Sales Offices | 87 |
| Circuit Component Lamps | 89 |
| Indicator Lamps | 117 |

PHYSICS AND CHARACTERISTICS OF GLOW LAMPS

CHAPTER 1

The neon glow lamp, which is also commonly referred to as a glow tube or neon bulb, is a cold-cathode, gas-discharge device. As well as having extensive use as a visual indicator, the neon bulb has characteristics which enable it to operate as a very versatile and inexpensive circuit component. This booklet is devoted to these characteristics and associated circuitry.

THEORY OF GASEOUS CONDUCTION IN THE NEON GLOW LAMP

The glow tube consists basically of two metallic elements spaced a short distance apart and immersed in neon gas at a moderately low pressure. The electrical conduction between these two elements is a very complicated phenomenon involving neutral atoms, excited atoms, positive ions, and electrons. In addition, the conduction mechanism in the neon bulb varies throughout the operating voltage-current range. A typical neon bulb characteristic is shown in Fig. 1.1.

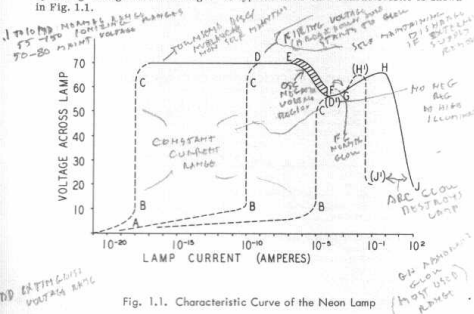

Fig. 1.1. Characteristic Curve of the Neon Lamp

Electrical conduction in the lamp requires the ionization of the neon gas, which consists of the separation of an electron from an atom resulting in a positively charged ion and a free electron. In order to break an electron away from an atom, energy must be supplied to it. This energy may be supplied by collisions between particles such as electrons or excited atoms; a process which requires the application of an electric field. Ionization may also be produced directly by external ionizing sources such as ultraviolet rays, x-rays, and cosmic rays. A third producer of ionization may be radioactive additives within the lamp.

The gas within the neon bulb is always in a state of partial ionization due to one or more of the ionizing sources just mentioned. As an increasing voltage is applied to the neon bulb there is a small increasing current flow due to the drift of electrons and ions which are made available by the action of these ionizing sources. The applied voltage produces an electric field which draws the positive ions to the cathode and the electrons to the anode. This current is indicated by one of the regions AB in Figure 1.1. A large portion of this current can be photoelectrons if the lamp is operating in ambient light.

As the voltage is increased, a point B is reached where all the available ions and electrons are being pulled from the gas and a further increase in voltage results in no further increase in current. This constant-current region is represented by the curves BC.

A further increase in the voltage across the lamp past the value represented by point C results in a rapid increase in current to the point D or D'. This discharge is called a non-self-maintained or a Townsend discharge. This increasing current is brought about through a phenomenon termed electron avalanche in which a moving electron (a so called primary electron) upon colliding with an atom may liberate another electron from the atom thus resulting in a positive ion and two electrons. These two electrons are now accelerated by the electric field and in turn may produce two more collisions. Thus there is an accumulating density of charge carriers available, and as they are attracted to the electrodes the current increase. If the external excitation which is producing the primary electrons should be removed the current will cease to flow, hence this discharge is termed non-self-maintained. The characteristic curve from A to D is dependent upon this external excitation.

When the voltage across the lamp is increased to a value represented by point D the gas in the lamp "breaks down" and begins to glow. This is defined as the breakdown or firing voltage. The current will increase to a value limited mainly by the resistance in the external circuit. If, after breakdown occurs, the external ionizing excitation source is removed, current will continue to flow and for this reason this type of discharge is referred to as a self-maintained discharge.

The voltage at which breakdown occurs is a function of the product of the interelectrode spacing and the gas pressure and does not depend upon these two parameters separately. This relationship between electrode spacing and gas pressure is known as Paschen's law. The breakdown voltage is also dependent upon the electrode material and the composition of the gas.

After breakdown occurs the lamp passes through a transition region EF which is an unstable region of operation. The shaded portion indicates the region in which oscillation can occur. This region is often referred to as the negative resistance region, since voltage decreases as current increase, contrary to normal behavior in a resistive element. In extremely high illumination the negative resistance region may be missing, as shown on the third curve, A to D'.

As current through the lamp is allowed to increase further, the lamp enters the normal glow discharge region represented by section FG in Figure 1.1 where voltage changes a minimum amount with a change in current. The operating voltage across the lamp at any point on the characteristic curve is termed its maintaining voltage and, of course, will vary with current. In the normal glow region the lamp maintaining voltage reaches its minimum value. (See section on Equivalent Circuits and General Formulae.) In the normal glow region the glow is confined to a portion of the cathode surface and the amount of cathode surface covered by the glow is somewhat proportional to the tube current.

If the lamp current is increased beyond the normal glow region (point G) the tube enters the abnormal glow region indicated by the section GH in Figure 1.1. When current is raised within this region the voltage across the lamp increases slowly. Most glow discharge devices are operated in the lower portion of this region.

As the current is increased in the abnormal glow region a value is reached where a sudden transition occurs and the voltage drops abruptly to a voltage represented by point J which is considerably lower than the normal glow maintaining voltage for the lamp. Some lamp types will follow the dotted curve from G to J'. At J or J' the current density has increased to a level such that the current concentrates itself in a small spot on the cathode and the discharge becomes an arc. This is characterized by a bluish discharge within the lamp. Operation in the arc region will soon destroy the neon bulb.

When the current through a neon bulb is decreased in the glow discharge region (usually by decreasing the voltage applied to the bulb in series with a resistance) a value is reached where the glow disappears and there is an abrupt decrease in bulb current to a very low value found in region BD. The voltage, measured across the bulb, at which this occurs is defined as the extinguishing voltage and is dependent upon the resistance in series with the bulb. It is always between the minimum maintaining voltage in the normal glow region and the breakdown voltage and it approaches breakdown voltage as resistance is increased. The value of the minimum extinguishing voltage, obtained by a low external resistance, is normally not much different than the minimum maintaining voltage in the normal glow region. (See section on Equivalent Circuits and General Formulae.)

GLOW LAMP CHARACTERISTICS

General

General Electric glow lamps for circuit component use can be designed for a wide range of voltages and currents, but currently available types are specified with initial breakdown voltages ranging from 55 to 150 volts and with maintaining voltages from about 50 to 80 volts. The design current range for circuit component glow lamps is from .1 milliamp to 10 milliamperes for continuous operation. All circuit component lamps contain two or three electrodes and are available in several physical configurations. Neon lamps can be divided into two general categories—standard brightness and high brightness. When stable electrical characteristics are the primary design parameter, the standard brightness types are recommended. In those applications where maximum light output is of primary importance—such as activation of light sensitive devices—the high brightness types are often utilized.

As in the case of all discharge lamps, glow lamps must be ballasted to prevent instantaneous burnout. Ballasting is generally performed by a resistor in series with the lamp. The particular value of resistor used, in combination with the applied voltage and lamp characteristics, determines the current through the lamp and thus its life and light output.

Detailed characteristics of available General Electric glow lamps are given in Chapter Six.

Response Time

The speed of response of glow lamps involves three different time intervals. They are ionization time, deionization time, and transmission time. Depending

upon the application, any one or all three of these may be important.

For the purpose of this discussion, the following definitions are assumed:

- A. Ionization time is the time required for full operating current and light output to be obtained following the application of a signal in excess of breakdown voltage to a non-conducting lamp.
- B. Deionization time is the time required for the lamp to recover initial breakdown voltage conditions following a period of conduction.
- C. Transmission time is the time required for a change in operating current to appear in the output following the application of a signal to a lamp already in a conducting state.

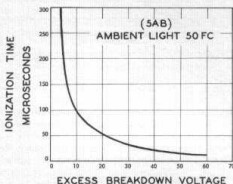

Fig. 1.2. Influence of Volts in Excess of Breakdown on Ionizing Time

The ionization time is a function of the applied voltage in excess of the static breakdown voltage. Static breakdown voltage is the voltage value at which a lamp first starts, in 5 to 50 foot-candles of ambient light, after 24 hours or more in the non-conducting state. No external starting aids, such as closely coupled electrostatic fields are present, and the applied voltage has a slow rate of rise in the order of volts per second. Figure 1.2 shows a typical ionizing time curve for a glow lamp in light. For an applied step voltage slightly in excess of breakdown the ionizing time may be of the order of 300 microseconds, while if voltages of 60 to 70 volts in excess are applied, this time may be reduced to less than 25 microseconds. In darkness these times are longer but can be reduced through the use of radioactive additives. However, "dark effect" cannot be completely eliminated without the use of prohibitively high radiation intensities. (See section on External Effects.)

The deionizing time is the time required for the complete recombination of the ions and electrons in the gas. Complete deionization is evidenced by a return to the lamp's static breakdown voltage from a lower voltage immediately following the cessation of conduction. This may require as much as 50 milliseconds. In normal applications the lamp is reionized before complete deionization has taken place, which extends the upper frequency to about 20 kilocycles. Figure 1.3 shows typical reionization times for a lamp as a function of the prior conduction current and the time interval between the trailing edge of one pulse and the leading edge of the next.

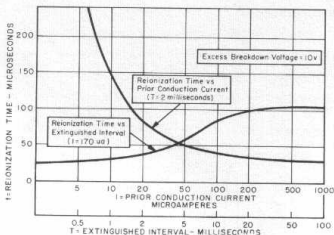

Fig. 1.3. Typical Variation in Reionization Time with Prior Conduction Current and Extinguished Interval

The transmission time of a small change of voltage through a conducting neon lamp is a function of the conduction current, and is approximately 6 microseconds at a current of 0.3 milliamperes in the 5AB. It increases with reduced current so that at 50 microamperes the transmission time is about 20 microseconds. For this reason the neon lamp alone cannot be used for the transmission of short pulses or steep wave fronts. However, with appropriate precautions against instability, a high frequency bypass capacitor can often be added to improve response.

External Effects

The static breakdown voltage and consequently the ionization time of glow lamps may be affected by external conditions.

DARK EFFECT

Since the cathode surface material is photosensitive, its emission can be greatly reduced by the absence of illumination. Glow lamps, in total darkness, become erratic, and may require many volts in excess of static values to start them. Conversely, in extremely high illumination levels, breakdown voltage approaches minimum maintaining voltage. One means for greatly reducing this "dark effect" is the use of mild radioactive additives, which is being done for a large number of General Electric glow lamps.

A method sometimes employed to eliminate the dark effect is to place a source of illumination, such as another glow lamp, within the enclosure. This should be lighted prior to the operation of the circuit glow lamps. The spectral quality of the incident light also influences dark effect, with the near ultraviolet wave lengths being most efficient in reducing the effect. Maintaining voltage is not noticeably affected by operation in darkness.

ELECTROSTATIC FIELDS

Electrostatic fields noticeably affect glow lamps. For example, if the voltage across the lamp is held below the static breakdown voltage, the appearance of an electrostatic field in proximity to the lamp can cause it to start. If the dark enclosure is a conductive shield, its polarity in relation to the lamp cathode will determine the direction in which the breakdown voltage changes. If the shield is of the same polarity as the lamp anode the dark starting voltage will be reduced somewhat. If at cathode polarity, the breakdown voltage will increase. This same effect can be achieved by mounting a conductor in the immediate vicinity of the lamp's electrodes and connecting it to the anode or cathode lead. No similar effect has been observed for magnetic fields.

The changes in breakdown voltage due to the foregoing conditions are pronounced when the lamp is in total darkness, but have negligible effect when the lamp is in normal, ambient illumination. Electrostatic fields have no noticeable effect upon the maintaining voltage.

TEMPERATURE EFFECTS

The firing voltage and maintaining voltage of glow lamps have a negative temperature characteristic. This temperature change is about 40-50 millivolts per degree Centigrade. This variation with temperature has different effects depending upon the application of the glow lamp. For example, in the sawtooth oscillator configuration described in Chapter Two the frequency may either increase or decrease with increasing temperature depending upon the particular operating conditions. For use as a voltage regulator this temperature change results in the regulating voltage decreasing with increasing temperature.

The glow lamp should never be used in temperatures exceeding 300° F and it is recommended that when the glow lamp is used as a circuit component, operation should be limited to the temperature range of -60° F to +165° F.

RADIATION EFFECTS

Tests have been made on glow lamps in operation as sawtooth oscillators under continuous gamma radiation up to levels of 1.2×10^5 Roentgen per hour. No appreciable or consistent changes were observed in the frequency, firing voltage or extinguishing voltage of the glow lamps which were tested. The results from these tests and from other reports indicate that short time operation of glow lamps is not appreciably affected by radiation even though the radiation may reach rather high levels of intensity.

If glow lamps remain under radiation, the glass of the lamps will gradually begin to color, starting from a light brown and progressively darkening. Prolonged radiation causes the glass to become brittle and the lamp may ultimately crack, thus destroying the lamp.

MISCELLANEOUS

After operation on direct current for some time, glow lamps will tend to polarize and a substantial difference between breakdown voltages will appear if polarity is reversed.

Glow lamps are also sensitive to the presence of high-intensity radio-frequency fields, since the gas will glow in such a field.

If the lamp is surrounded by a metal shield during conduction, the capacitance between the electrodes and the shield will increase with increasing lamp current. No accurate data on this phenomenon is now available.

If placed in storage for prolonged periods of time some glow lamps experience a rise in initial breakdown voltage. Subsequent breakdowns will be at or close to the original level. This phenomena is called "standing rise" and, when it occurs, can cause a change occasionally above 5 volts from those breakdown values experienced prior to storage. High quality lamps, such as the 5AG-A, receive special treatment and testing in order that lamps experiencing appreciable standing rise can be eliminated.

Equivalent Circuits And General Formulae

When non-conducting, a glow lamp may be treated as a large resistance (normally in the megohm range) shunted by a capacitance of about one micro-microfarad.

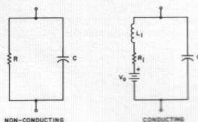

Fig. 1.4. Equivalent Circuits for the Glow Lamp

When operating, the lamp may be considered as a counter E.M.F. in series with a dynamic internal resistance and inductance, all of which are paralleled by the shunt capacitance mentioned above (see Fig. 1.4). The internal resistance (R_1) and inductance (L_1) are nonlinear, and will change with changes in the current through the lamp. The D.C. value of R_1 is given by the reciprocal of the slope of the characteristic curve at the operating point. Typical values of R_1 and also the counter E.M.F. (designated as V_0) are given for the lamps DC rated current conditions in Figure 1.5.

| Lamp Types | V_0 -Volts | R_1 -Ohms |
|---------------------|--------------|-------------|
| 5AG, 5AG-A | 57 | 5,000 |
| A 1A, 8AB, K2A, 5AB | 55 | 5,500 |
| A9A, 3AD, 3AG | 55.5 | 4,000 |
| 5AH | 59 | 500 |
| B 1A, 6AC, 8AA, | 54 | 3,000 |
| 5AJ | 55 | 1.5K |

Fig. 1.5. Average DC Characteristic Values for Glow Lamp Equivalent Circuit at Rated Current

It can readily be seen that the counter E.M.F. must be subtracted from the supply voltage when making DC lamp current calculations. Therefore:

$$I = \frac{V_s - V_0}{R_1 + R_x} \quad (1.1)$$

where V_s is the supply voltage, V_o the counter E.M.F., R_i the internal resistance of the lamp and R_x all external resistance in series with the lamp.

It is also possible to approximate maintaining voltage (V_m) through the use of the formula:

$$V_m = V_o + IR_i \quad (1.2)$$

In a similar manner, extinguishing voltage (V_e) can be approximated as:

$$V_e = V_o + .012 \sqrt{R_x} \quad (1.3)$$

Rated Life And Aging

In order to appreciate the parameters involved in setting the rated life of a glow lamp it is necessary to consider separately the two basic glow lamp types—standard brightness and high brightness.

STANDARD BRIGHTNESS LAMPS

Standard brightness types, such as the A1A and 5AB, will continue to light for an indefinite period if given proper care and operated under suitable voltage and current conditions. However, their useful life is generally limited by slow bulb blackening with consequent reduction in lamp brightness, and by a gradual rise in breakdown and maintaining voltages. For these reasons, those standard brightness types used purely for visual indication are said to reach end of rated life when their light output has decreased to 50% of its initial value.

Obviously, it is the change in breakdown and maintaining voltages which are of primary interest when the lamp is used as a circuit component, and the rated life of lamps intended for circuit component application is therefore based upon this change. The lamp specifications in Chapter Six show the average voltage changes which can be expected to occur after operation at design current for a stated number of hours. Some glow lamps are made to special tolerances or ranges. One example is the breakdown voltage of the 5AB-A, which remains within its initial tolerances for a stated number of hours.

For currents up to approximately one milliamp, the useful life of standard brightness glow lamps, either as a visual indicator or as a circuit element, is inversely proportional to the third power of the lamp current. For example, the rated life figure of a particular neon lamp may be either multiplied or divided by eight by either reducing the current to one-half normal rated current or doubling it, respectively.

Operation of these types below 50 microamperes should be avoided for several reasons, among them the possibility of operation in the negative resistance portion of the lamp characteristic curve.

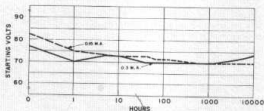

Fig. 1.6. Typical Firing Voltage Change as a Function of Operating Time

Figure 1.6 shows typical life-voltage curves for groups of A1A lamps run at .3 and .15 milliamperes.

An exception to many of the foregoing statements is the 5AH family. Although standard brightness lamp, the 5AH family has the ability to carry considerably greater current than most glow lamps. Its life is inversely proportional to the 5th power of the current. For best results the 5AH family should not be operated below 1.5 milliamps.

In general, the life of a standard brightness glow lamp on DC is about 60% of the life expected on AC, when the DC current is equal to the RMS AC value. However, when equal DC and RMS AC voltages and equal resistances are utilized life will be approximately the same.

HIGH BRIGHTNESS LAMPS

The high brightness lamps, on an equal life basis, have about ten times the brightness of the standard brightness types. In addition, light output remains quite constant throughout most of lamp life. They are thus suited for use with photoconductors and other light-activated semiconductors.

Their failure mode is also somewhat different from the standard brightness types. Instead of a gentle rise in breakdown and maintaining voltage throughout life which continues ad infinitum, the high brightness lamp, near end of life, experiences an abrupt upward change in breakdown and maintaining voltage which continues unabated until breakdown voltage has reached the 120 volt AC supply voltage and the lamp will no longer start.

The lamp is also considerably more erratic in its electrical behavior than is the standard brightness type. Tanges in breakdown and maintaining voltage initially are greater than those associated with standard brightness types, and changes throughout life can be expected to be more severe. No really satisfactory method of stabilizing this lamp type has yet been advanced. For this reason General Electric does not recommend this lamp type where critical voltage characteristics are a necessity.

For currents up to approximately 6 milliamps the useful life of high brightness glow lamps is inversely proportional to about the sixth power of the average lamp current.

Operation of this type below 1 milliamp should be avoided for the reasons stated earlier. Life of the high brightness lamp on DC is approximately half that for equal RMS AC operation.

GENERAL

In both the standard and high brightness types, the greatest changes in breakdown and maintaining voltages occur during the first 100 hours of operation at rated current, after which the voltage levels change only slightly for the remaining life of the lamp. These changes may be either a rise or a drop in voltage. There is some evidence that lamps having a low breakdown voltage initially change the least and usually upward, while those having a high initial breakdown voltage generally decrease with age.

Many methods for aging or seasoning glow lamps have been suggested and tried, in an attempt to accelerate the process. However, most of these methods have some disadvantage. Seasoning at high currents for short periods of time, for example, usually does a temporary job because the breakdown voltage generally drifts back toward its initial value. When glow lamps are run or pulsed at excessively high current to accomplish seasoning, much of the useful life may be used up before the lamps are actually put to work. In general, the

most satisfactory method of aging is to operate the lamps at about twice their rated current for twenty-four hours, and then to follow this by another twenty-four hour period during which the lamps are operated under the circuit conditions to which they will be subjected. Exceptions to this rule-of-thumb might be the 4AB, 4AC, 5AH family, and 5AJ family. (See data sheets on these lamps in Chapter Six for aging instructions.)

Several circuit component glow lamps are subjected to an aging treatment to enhance their stability prior to voltage selection. Among these types are the 3AG-A, 3AG-B, 3AG-C, 5AB-A, 5AB-B, 5AB-C, 5AC, 5AG, and 5AG-A. After operation on direct current for some time, glow lamps will tend to polarize, and a substantial difference in breakdown voltage will occur if the polarity is reversed. For this reason, a colored dot is used to mark anode polarity on all preaged, circuit component types. Lamps which are not preaged by the manufacturer should be put through an aging schedule before they are used in an application where voltage tolerances are critical.

In many circuit applications the glow lamp will be pulsing on and off rather than having a steady current flowing through it. In such applications the duty cycle of the lamp may be so small as to extend its useful life to many times the life it would have if in continuous operation. Peak currents, pulse waveshape, and pulse time duration all influence life under these conditions. If these factors can be determined, through the use of a scope or other means, an approximation of life performance can be made. The current waveshape should first be raised to the appropriate power—third for standard brightness lamps, sixth for high brightness, etc.—and then integrated. Life will vary as the inverse ratio of the resulting "steady state" current and the rated current, raised to the appropriate power.

It is well to remember that since the glow lamp is a cold cathode device its useful life is not being consumed during the time it is not drawing current. This is particularly important in many logic operations where a glow lamp may be in an off condition for a large percentage of the equipment's operating time.

Darkening of the glass walls of a glow lamp is caused by the deposition of particles lost from the cathode during the severe ion bombardment of normal operation. This continual disintegration of the cathode surface is referred to as sputtering. This loss of cathode material is also a determining factor in the useful life of the lamp.

Light Output

The use of a glow lamp as a circuit component has the added advantage that its light output may often be an indication of its state of operation or even an indication of the amount of current flowing through the lamp. In addition, the glow lamp may be used as a polarity indicator since the glow is confined to the cathode region.

The light output of all glow lamps varies in direct proportion to the current through the lamp. The light from neons is confined mainly to the yellow and red regions of the spectrum between 5200 and 7500 Angstroms. A band of energy in the infrared region between 8200 and 8800 Angstroms is also emitted. Spectral distribution curves for both the standard and high brightness types are shown in Figures 1.7 and 1.8. The efficiency of the standard brightness type is low, averaging about .06 lumens per milliamp. The high brightness types average .15 lumens per milliamp, about three times that of the standard brightness. However, because of the ability of the high brightness lamp to withstand higher currents, its light output is about ten times that of the standard brightness lamp, when the two are compared on an equal life basis.

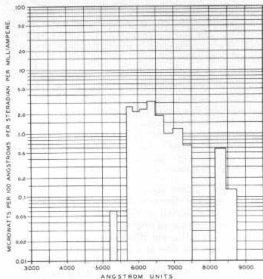

Fig. 1.7. Profile of Radiant Energy Distribution for Standard Brightness Neon Glow Lamps such as A1A, C7A, A9A, K2A, 5AB, B7A, B1A, 5AG.

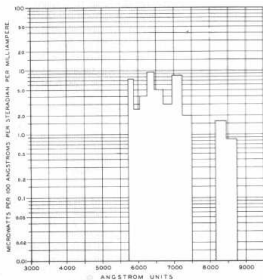

Fig. 1.8. Profile of Radiant Energy Distribution for High Brightness Neon Glow Lamps such as C2A, C9A, K3A, 3AH, B2A, A3C.

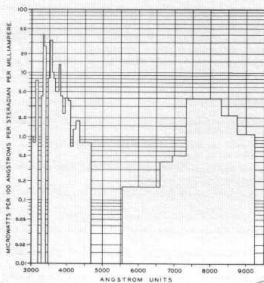

Fig. 1.9. Profile of Radiant Energy Distribution for Argon Glow Lamps AR-1, AR-2, AR-3, AR-4, AR-9.

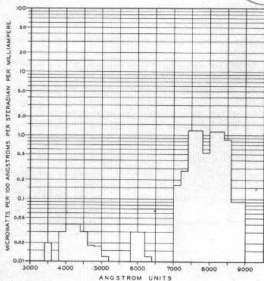

Fig. 1.10. Profile of Radiant Energy Distribution for Helium-Argon Glow Lamps HA-3, HA-6, HA-7.

Although the low efficiency of the neon types severely limits their usage as an illuminant, they are widely used as indicators since operation at even a few microamperes of current will give an easily visible indication.

Spectral distribution curves of the argon and the helium-argon glow lamps are shown in Figures 1.9 and 1.10 respectively. The argon lamp, because of its output in the near ultraviolet, finds considerable usage as a marker for high speed photographic purposes and also as a source of black light energy.

LIST OF REFERENCES

- "The Application of the Gaseous Discharge Tube to Problems of Voltage Regulation", *Journal of Scientific Instruments*, vol 14, May 1937, pp 161-164.
- "The Mechanism of Electrical Discharge in Gases of Low Pressure", M.J. Druyvesteyn and F.M. Penning, *Reviews of Modern Physics*, vol 12, April 1940, pp 87-174.
- "Some Characteristics and Applications of Negative-Glow Lamps", H.M. Ferree, Paper 40-110, AIEE Convention, Swampscott, Massachusetts; June 24-28, 1940.
- "Current Rating and Life of Cold-Cathode Tubes", G.H. Rockwood, *AIEE Transactions*, vol 60, September 1941, pp 901-903.
- "Gaseous Conductors", J.D. Cobine, McGraw-Hill Book Company, 1941.
- "Characteristics of Certain Voltage-Regulator Tubes", G.M. Kirkpatrick, *Proc. I.R.E.*, vol 35, May 1947, pp 485-489.
- "Some Characteristics of Glow-Discharge Voltage Regulator Tubes", E.W. Titterton, *Journal of Scientific Instruments*, vol 26, February 1949, pp 35-36.
- "Initial Drifts in Running Voltage of Glow-Discharge Regulator Tubes", F.A. Benson, *Journal of Scientific Instruments*, vol 27, March 1950, pp 71-72.
- "The Characteristics of Some Miniature High-Stability Glow-Discharge Voltage-Regulator Tubes", F.A. Benson, *Journal of Scientific Instruments*, vol 28, November 1951, pp 339-341.
- "Neon Lamps as Circuit Elements", W.R. Kincheloe, Jr., Technical Report No. 10, Stanford University Electronics Research Laboratory, May 26, 1952.
- "Peak Noise Characteristics of Some Glow Discharge Tubes", H. Bachle and F.A. Benson, *Journal of Scientific Instruments*, vol 30, April 1953, pp 124-126.
- "The Equivalent Circuit of a Gas Discharge Lamp", C. Zwicker, *Philips Technical Review*, vol 15, December 1953, pp 161-168.
- "Effects of Ambient Temperature Variations of Glow-Discharge Tube Characteristics", F.A. Benson and G. Mayo, *Journal of Scientific Instruments*, vol 31, April 1954, pp 118-120.
- "Miniature Lamps-Marvels in Size, Performance, Reliability", G.F. Prideaux, *General Electric Review*, vol 58, September 1955, pp 15-17.
- "Glow-Discharge Stabilizers, Influence of Some Tube Parameters on Impedance-Frequency Variations", F.A. Benson and L.J. Bental, *Wireless Engineer*, vol 32, December 1955, pp 330-336.
- "Note on Positive Ion Transit Time in Glow-Discharge Tubes", C. Yeh, *Journal of Applied Physics*, vol 27, January 1956, pp 98-99.
- "Breakdown in Gas Tubes", A.A. McKensie, *Electronics*, January 1956, p 176.
- "Glow-Discharge Tubes - Initial Drift and Running Voltage/Temperature Characteristics", F.A. Benson and L.J. Bental, *Wireless Engineer*, vol 33, February 1956, pp 33-38.
- "Vacuum-Tube and Semiconductor Electronics", J. Millman, McGraw-Hill Book Company, 1958, Chapters 12 and 13.
- "Neon Lamps for Low-Speed, Low-Duty-Cycle Logic", P. Laakman, *Electronic Design*, June 7, 1962, p 56 and June 21, 1962, p 62.

The neon glow lamp has found extensive circuit component use as a switch in relaxation oscillator applications. The two basic types of relaxation oscillators are the sawtooth oscillator and the astable (free running) multivibrator. This chapter will present various configurations of each type of glow lamp relaxation oscillator and will examine their operating characteristics. Design aids will be given to assist the circuit designer in utilizing the glow lamp in his circuit applications.

GLOW LAMP SAWTOOTH OSCILLATOR

The sawtooth oscillator utilizes a glow lamp which serves as a switch to cause a capacitor to alternately charge and discharge. The two basic configurations of the sawtooth oscillator are shown in Figure 2.1 with representative waveforms shown for each circuit.

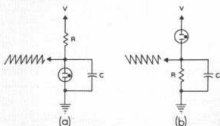

Fig. 2.1. Basic Sawtooth Oscillator Configurations

The frequency of oscillation for each type of oscillator is determined by the values of the associated circuit components, the supply voltage, and the operating characteristics of the glow lamp. The lower frequency of operation is essentially unlimited; however, the upper frequency is normally limited by the glow lamp due to the time required for the ionization and deionization of the gas. The upper frequency limit for normal sawtooth operation is on the order of 20 kilocycles per second.

The peak-to-peak voltage amplitude of the output signals is the difference between the dynamic firing and extinguishing potentials of the particular lamp being used. The output voltage amplitude varies throughout the frequency range of operation due to the changing values of the dynamic firing and extinguishing potentials.

Basic Sawtooth Oscillator Operation

As mentioned earlier the operation of each type of oscillator shown in Figure 2.1 utilizes the charging and discharging of a capacitor to generate the sawtooth waveform. However, the difference in operation between the two types of circuits results in output signals of opposite polarity.

As the voltage is applied to the circuit of Figure 2.1a the voltage across

the lamp is initially zero since the capacitor is not able to change its voltage instantaneously. The capacitor then begins to charge toward the supply voltage V with a time constant τ equal approximately to R times C . Since the lamp is in the non-conducting state at this time, the resistance of the lamp is so large that its shunting effect is usually negligible.

When the increasing voltage across the lamp reaches the dynamic break-down voltage V_f , the lamp switches into the conducting state with the current increasing to a relatively high value. The capacitor then begins to discharge toward ground through the resistance of the lamp. The dynamic lamp resistance in the conducting state is variable depending on the value of the current flowing in the lamp, initially having a value of a few thousand ohms. The capacitor thus quickly discharges with the voltage across the lamp decreasing rapidly until it reaches the dynamic extinguishing voltage V_e . The lamp then switches to the high-resistance state with the lamp ceasing to glow. With the glow lamp thus switched to the high resistance state the capacitor again begins to charge toward the supply voltage and the cycle repeats. In order that the oscillations will be sustained certain operating conditions must be met. These conditions will be described in the next section.

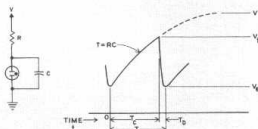

Fig. 2.2. Single Cycle of Typical Sawtooth Output

A typical low frequency steady-state output voltage waveform is shown in Figure 2.2. The various voltage levels are indicated in the figure. T_C is the time during which the capacitor is charging and T_D is the time during which the lamp is fired and the capacitor is discharging. For low frequency oscillations T_D is much less than T_C and therefore, the period T is approximately equal to the capacitor charging time T_C .

During the time the capacitor is charging the equation for the voltage output waveform as a function of time is:

$$v(t) = V_e + (V - V_e) \left(1 - e^{-\frac{t}{RC}}\right) \quad 0 < t < T_C \quad (2.1)$$

at the time T_C :

$$V_f = V_e + (V - V_e) \left(1 - e^{-\frac{T_C}{RC}}\right) \quad (2.2)$$

Solving for T_C :

$$T_C = RC \ln \frac{V - V_e}{V - V_f} \quad (2.3)$$

Assuming that $T_D \ll T_C$, which is true for low frequency oscillations, the

period of a single cycle T is then approximately equal to T_C so that:

$$T = RC \ln \frac{V - V_e}{V - V_f} \quad (2.4)$$

The frequency of oscillation is equal to the reciprocal of the period. Therefore, the equation for the low frequency oscillation of the glow lamp sawtooth oscillator is:

$$f = \frac{1}{RC \ln \frac{V - V_e}{V - V_f}} \quad (2.5)$$

where \ln is the natural logarithm.

Alternate equations for the frequency of oscillation are:

$$f = \frac{1}{2.3 RC \log \frac{V - V_e}{V - V_f}} \quad (2.6)$$

$$f = \frac{1}{RC \ln \left(1 + \frac{V_s}{V - V_f}\right)} \quad (2.7)$$

where V_s is the peak-to-peak voltage amplitude of the output signal.

Equation 2.5 is a good approximation to the operating frequency for frequencies less than about 200 cps. For this lower frequency region the dynamic voltages V_f and V_e may be approximated by the DC firing voltage V_F and the DC maintaining voltage V_M respectively so that for frequencies less than 200 cps:

$$f = \frac{1}{RC \ln \frac{V - V_M}{V - V_F}} \quad (2.8)$$

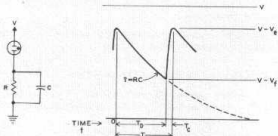

Fig. 2.3. Single Cycle of Typical Sawtooth Output

In Figure 2.3 is shown a single cycle of a typical low frequency output signal for the second type of basic sawtooth oscillator shown in Figure 2.1b.

As voltage is applied to the circuit the full voltage is initially placed across the lamp and the lamp fires. The capacitor then charges up rapidly through the low resistance of the conducting lamp until the voltage across the lamp reaches the extinguishing voltage at which time the lamp switches to the high-resistance state and thus essentially isolates the R-C network from the supply voltage. The capacitor then begins to discharge through R with a time constant τ equal to R times C. When the voltage across the resistor-capacitor network has decreased to a value such that the voltage across the lamp reaches the firing potential of the lamp, the lamp will fire and the capacitor again charges rapidly through the lamp. As with the circuit of Figure 2.1a the time during which the lamp is fired is much shorter than the off time for low frequency oscillations.

The equation for the voltage output waveform during the time of the capacitor discharge is:

$$v(t) = (V - V_e) e^{-\frac{t}{RC}} \quad 0 < t < T_D \quad (2.9)$$

Then at time T_D :

$$(V - V_f) = (V - V_e) e^{-\frac{T_D}{RC}} \quad (2.10)$$

Solving for T_D :

$$T_D = RC \ln \frac{V - V_e}{V - V_f} \quad (2.11)$$

Then since the time T_D is approximately equal to the period of the waveform for low frequencies:

$$T = RC \ln \frac{V - V_e}{V - V_f} \quad (2.12)$$

The frequency is the reciprocal of the period so that:

$$f = \frac{1}{RC \ln \frac{V - V_e}{V - V_f}} \quad (2.13)$$

which is identical to equation 2.5.

Therefore the same design equations are applicable to each type of sawtooth oscillator circuit shown in Figure 2.1.

Conditions Necessary for Sustained Oscillations.

In order to obtain sustained oscillations in a sawtooth oscillator the associated components and the supply voltage must be properly chosen.

The only requirement on the supply voltage for a sawtooth oscillator is that the magnitude of the voltage must exceed the firing potential of the glow lamp being used. Normally, it is desirable to have the supply voltage as high as is practicable since the linearity of the output waveform increases as the supply voltage increases and in addition oscillator circuits tend to be more stable for higher values of supply voltage. The glow lamp may be used

equally well with positive or negative supply voltages, bearing in mind that better operation is obtained by observing the indicated polarity (if any) of the lamp.

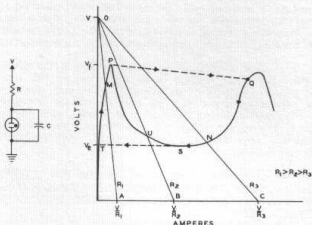

Fig. 2.4. Volt-Ampere Characteristic Curve Showing Operating Conditions for Various Values of Load Resistance.

The value of the external resistor must be chosen so as to satisfy certain conditions for oscillation. These conditions will be determined by referring to Figure 2.4 which shows a volt-ampere characteristic waveform similar to a typical glow lamp characteristic. The operating characteristics will be determined for three values of resistance R_1 , R_2 and R_3 whose load lines are represented in Figure 2.4 by the line segments OA , OB , and OC respectively.

Consider first the case where $R = R_1$. As the supply voltage is applied to the circuit the capacitor begins to charge toward the supply voltage and reaches the equilibrium point M which is the intersection of the load line with the characteristic curve. In this case the value of resistance R_1 is on the same order as the "non-conducting" resistance of the lamp with the result that not enough voltage is dropped across the lamp to cause it to fire. The voltage across the lamp will, therefore, remain at a value corresponding to point M and the circuit is unable to initiate oscillations since the lamp is incapable of firing.

Now consider the condition where $R = R_2$. As the supply voltage is applied to the circuit the voltage across the lamp is initially zero due to the parallel capacitor. As the capacitor begins to charge up, the voltage across the lamp increases along the characteristic curve to point P , the firing voltage of the lamp. The capacitor discharges through the lamp, increasing lamp current to point Q . As the capacitor then discharges rapidly, the voltage and current

of the lamp follow the characteristic curve along the segment QS. As the point S is reached, the voltage must begin to rise as the current decreases (toward point U) but since the passive elements of the circuit are incapable of providing an increasing voltage for a decreasing current and the value of R_2 is too large to permit sufficient current to flow through the lamp to maintain conduction, the lamp stops conducting and switches rapidly along a constant voltage line to point T. The capacitor then begins to charge again toward the supply voltage V and the cycle repeats. Therefore, since the load line of the resistance R_2 intersects the volt-ampere characteristic curve within the negative resistance region represented by the curve SP the circuit is incapable of reaching an equilibrium point and will continue to oscillate.

If R is decreased still further to the value of R_3 the lamp will begin conducting when the firing voltage is initially reached and after switching to point Q the capacitor will discharge through the lamp until point N is reached which is the point of intersection of the load line with the volt-ampere characteristic curve of the lamp. This point is a stable point where the value of resistance is low enough to provide a sufficient current to maintain conduction through the lamp. The lamp will, therefore, remain in this conducting state and will not oscillate.

From the foregoing discussion it is apparent that in order to obtain sustained oscillations the value of the external resistance R must be chosen such that the load line intersects the glow lamp characteristic curve in the negative resistance region.

Design of Glow Lamp Sawtooth Oscillators.

Due to the nonlinear characteristics of the glow lamp and the variation of the voltage parameters between lamps, prediction of the actual frequency of oscillation for any particular glow lamp can only be approximate. Therefore, if a circuit is to oscillate at a given frequency the design of the circuit is often best handled by a trial and error approach.

If the frequency of oscillation is to be less than 200 cps the parameters may be determined quite accurately by using equation 2.5 or its alternate forms. In this case, the firing and maintaining voltages for the lamp should be first measured and then by choosing any two of the parameters R, C, or V the value of the third may be determined from the equation 2.8.

In addition to using equation 2.8 a number of curves have been obtained for three types of lamps giving the average oscillating frequency as a function of R and C for several values of supply voltage. These design curves are shown in Figures 2.5 through 2.10 and are for pre-aged 5AB, 5AG-A, and 4AC glow lamps. The curves are helpful in determining the approximate frequency of oscillation for a given type of lamp especially for frequencies above approximately 200 cps where equations 2.5 through 2.8 are not applicable. The design curves of Figures 2.5 through 2.10 also indicate typical values of resistance for use with the different types of lamps. As described previously, the value of resistance for which a circuit is capable of oscillating depends upon the intersection of the resistance load line with the volt-ampere characteristic of the lamp. For oscillations to be maintained this intersection must occur in the negative resistance region of the lamp characteristic.

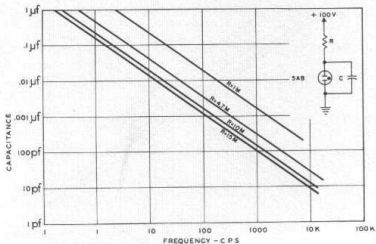

Fig. 2.5. Operating Frequencies as a Function of Resistance and Capacitance. (5AB at 100V)

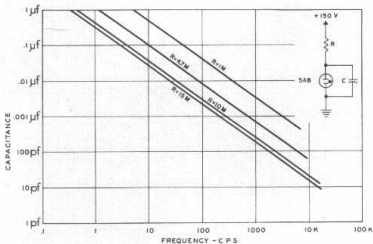

Fig. 2.6. Operating Frequencies as a Function of Resistance and Capacitance. (5AB at 150V)

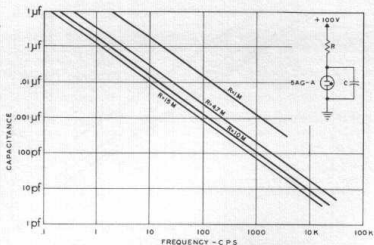

Fig. 2.7. Operating Frequencies as a Function of Resistance and Capacitance. (5AG-A at 100V)

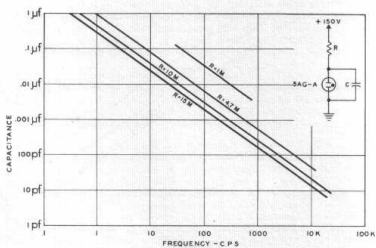

Fig. 2.8. Operating Frequencies as a Function of Resistance and Capacitance. (5AG-A at 150V)

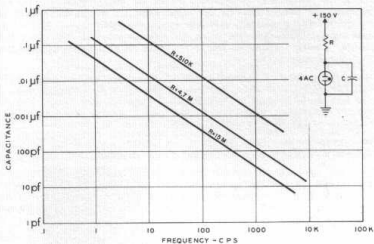

Fig. 2.9. Operating Frequencies as a Function of Resistance and Capacitance. (4AC at 150V)

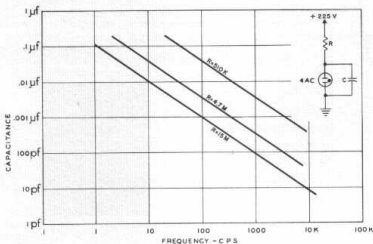

Fig. 2.10. Operating Frequencies as a Function of Resistance and Capacitance. (4AC at 225V)

The maximum value of resistance with which a circuit will oscillate is normally greater than 50 megohms so that in most applications the maximum value of resistance will depend more on other considerations than on the conditions for oscillation. On the other hand, the minimum value of resistance required for sustained oscillations is generally more critical and is dependent upon the associated value of capacitance and the supply voltage. In addition, among lamps of one type there is a variation in the minimum useable value of resistance.

Figure 2.11 shows a typical range of the minimum value of resistance required for oscillation as a function of the associated capacitance. The curve is for an 5AB lamp with a supply voltage of 150 volts. The value of minimum resistance increases as the supply voltage increases. For the 5AB lamp R_{min} at 150 volts is approximately twice that at 100 volts.

For general glow lamp sawtooth oscillator applications the range of resistance is normally between 1 megohm and 22 megohms.

Once the approximate circuit parameter values have been determined and the circuit is oscillating, the desired operating frequency may be obtained by variation of either R or C or the supply voltage. Normally this final adjustment is best made by using a potentiometer in the resistance branch of the circuit.

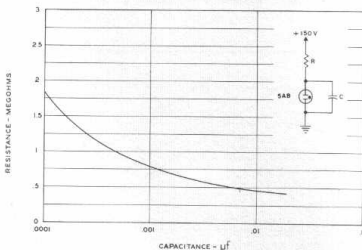

Fig. 2.11. Minimum Value of Resistance for Oscillation as a Function of the Capacitance.

Operating Characteristics of Sawtooth Oscillators.

OUTPUT WAVESHAPE

The shape of the output signal from a glow lamp sawtooth oscillator is determined mainly by the magnitude of the supply voltage and the frequency of oscillation.

For supply voltages only slightly greater than the firing voltage of the lamp the output waveform will be quite rounded. By increasing the supply voltage the rounding will decrease and the output waveshape will become more linear as is desired when the sawtooth output is to be used as a sweep signal or other time base generator.

For low frequency oscillations the time during which the tube fires is a small percentage of the period of the signal and the resulting waveshape is a typical sawtooth signal. An example of such an output is shown in Figure 2.12.

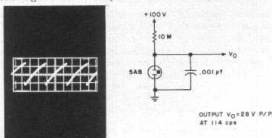

Fig. 2.12. Typical Sawtooth Oscillator Low Frequency Output.

As the frequency of oscillation increases the time required for the ionization and de-ionization of the gas become a more appreciable part of the total period. Thus, a rounding of the waveform at the discontinuities occurs. In addition, the time required for the capacitor to either charge or discharge through the fired lamp becomes an increasingly larger percentage of the total period. These effects are shown in Figure 2.13 for a 5AB lamp oscillating at a frequency of 7150 cps.

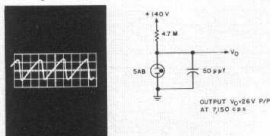

Fig. 2.13. Typical Sawtooth Oscillator High Frequency Output.

Although the normal upper frequency limit for sawtooth oscillations is about 20 kilocycles per second, glow lamps may often switch into sinusoidal oscillations at frequencies approaching 50 kilocycles per second. Figure 2.14 shows a typical output for a 5AB glow lamp operating in this sinusoidal

mode. The amplitude of these sinusoidal oscillations is much less than the amplitude of normal sawtooth oscillations for the same lamp. In addition, the existence of these oscillations depends on fairly critical adjustment of the supply voltage.

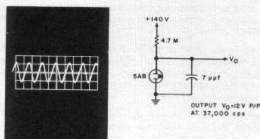

Fig. 2.14. Sinusoidal Output of Glow Lamp Oscillator Operating in High Frequency Region.

In general, the low voltage glow lamps such as the 5AB and 5AG-A are very stable and consistent in their output voltage waveforms over the normal frequency range of operation. Although the high voltage lamps, 4-AB and 4AC, offer the possibility of a higher output signal, their waveforms can become erratic at frequencies greater than 1000 cps. They are, therefore, better suited for use in low frequency oscillator applications.

Variations of Glow Lamp Parameters as a Function of Frequency.

The inherent nonlinearity of the glow lamp and the rather long times required for ionization and deionization of the gas leads to variations of the glow lamp parameters as a function of frequency when operating in the basic sawtooth oscillator configuration. These variations are evident in the firing and extinguishing voltages and in the deviation of the actual operating frequency from the calculated frequency obtained by using the equation for low frequency oscillations. The following observations were made using samples of pre-aged 5AG lamps.

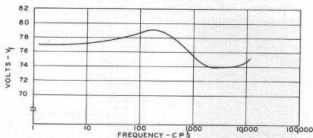

Fig. 2.15. Variation of Dynamic Firing Voltage as a Function of Frequency.

Figure 2.15 shows a typical response curve for the dynamic firing voltage V_f as a function of frequency. The supply voltage is held constant as +100.0 volts and both R and C are varied to obtain the curve. Note that as the frequency increases from the low frequency end the firing voltage reaches a maximum

at approximately 200 cps then decreases to a minimum at about 4000 cps after which the response again rises until oscillations cease. The difference between the maximum and minimum values on the curve is about 5 volts. The response curve for the firing voltage when plotted and extended to frequencies less than .1 cps tends to approach the DC firing voltage.

The response of the dynamic extinguishing voltage V_e as a function of frequency is a more complicated phenomenon since V_e is also a function of the value of R and C used in the oscillator circuit. Figure 2.16 shows a typical family of curves for constant values of resistance R with the capacitance C varied to change the frequency.

From the curves it is seen that the lowest extinguishing voltage is obtained for the largest value of resistance and in this case occurs at approximately 1000 cps. In addition, the extinguishing voltage is essentially independent of the value of resistance for very low frequencies and is approximately equal to the DC maintaining voltage.

Since the extinguishing voltage is dependent upon the value of the external resistance R , while the firing voltage is not, the difference between these two voltages is also dependent on the value of R . The difference between the dynamic firing voltage and the dynamic extinguishing voltage is the peak-to-peak amplitude of the sawtooth output signal which is designated by V_a .

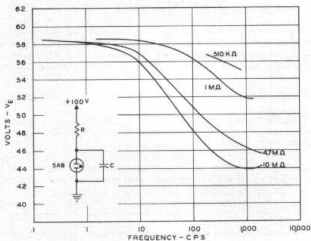

Fig. 2.16. Variation of Extinguishing Voltage - Constant Resistance.

A typical plot of V_a versus frequency is shown in Figure 2.17 for a fifteen megohm resistance. In this case V_a varies from a low frequency amplitude of about 18 volts to a maximum amplitude of about 32 volts at 500 cps. This amplitude variation with frequency is greater for larger values of R than it is for smaller values of R due to the dependence of the extinguishing voltage on the resistance as shown in Figure 2.16.

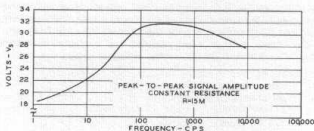

Fig. 2.17. Variation of V_s as a Function of Frequency - Constant Resistance.

From the foregoing it is seen that the maximum peak-to-peak output signal for a particular 5AB glow lamp is normally obtained by operating the oscillator in the frequency region of 200 - 2000 cps and by using a large value of external resistance.

As shown previously, the equation for determining the low frequency oscillating frequency of the basic sawtooth generator is:

$$f = \frac{1}{RC \ln \frac{V - V_c}{V - V_f}} \quad (2.14)$$

In investigating how valid this equation is over the entire range of operating frequencies the above equation is altered by the addition of a multiplying factor α and then α is evaluated as a function of frequency. The revised equation is:

$$f = \frac{1}{\alpha RC \ln \frac{V - V_c}{V - V_f}} \quad (2.15)$$

so that:

$$\alpha = \frac{1}{fRC \ln \frac{V - V_c}{V - V_f}} \quad (2.16)$$

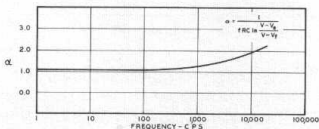

Fig. 2.18. Deviation of Operating Frequency from Low Frequency Equation.

Figure 2.18 shows a typical plot of α as a function of frequency. Note that α is essentially constant up to a frequency of about 200 cps and then begins to rise. The value of α in the low frequency region is 1.05 and was very consistent among the 5AB lamps tested. Thus, a more accurate equation for the design of 5AB sawtooth oscillators in the low frequency region is:

$$f = \frac{1}{1.05 RC \ln \frac{V - V_c}{V - V_f}} \quad (2.17)$$

TEMPERATURE EFFECTS

Glow lamp oscillators which are to be used under changing temperature conditions may be expected to have varying characteristics as a function of the temperature. The variation in frequency is essentially linear with temperature but the degree and direction of change from the frequency at room temperature appears to be dependent upon the frequency of operation. The change in frequency with temperature may go as high as about 1.5% of the frequency at room temperature per 10°C change in temperature. The dynamic breakdown voltage and dynamic extinguishing voltage each decrease as the temperature increases but the rate of decrease is again variable between lamps and under different operating conditions.

Glow lamps will operate properly as sawtooth oscillators over a temperature range of -50 to +80 degrees centigrade (-58 to +176 degrees Fahrenheit). The glow lamp should never be used in ambient temperatures exceeding 300°F and it is recommended that when the glow lamp is used as a circuit component operation should be limited to the temperature range of -60°F to +165°F.

TIME STABILITY OF OSCILLATORS

When employing glow lamps in oscillator configurations three types of time variations may be encountered. The first is the short term frequency instability which requires a length of time before the circuit has reached a steady frequency of operation when the lamp is being used for the first time or after it has not been used for a period of time. The second type of time variation is a gradual change in frequency of oscillation as the lamp parameters change with age. The third type of time variations found in a limited number of lamp types is a random change in frequency of operation caused by a rapid change in lamp parameters.

These variations in operating frequency are normally the result of a change in either, or both, the firing voltage and extinguishing voltage of the lamp. Such changes can be minimized by employing the following practices:

Initial short term instabilities may be reduced by pre-aging or seasoning the lamp. (See Chapter Six for procedure.) Each seasoning procedure should have a period of time where the lamp is operating very near the circuit conditions. If the lamp has been thoroughly seasoned and is quiescent for a day or more there still may be a shift in frequency of a few per cent during its first few minutes of operation.

The second mentioned instability, changes throughout life, may be minimized by operation below rated lamp current. Extremely low currents can

lead to the third type of instability. These changes, of course, can be compensated for by circuit adjustment if the circuit is critical.

The third type of instability may be encountered particularly when using the high voltage 4AB and 4AC. These lamps result in higher output voltage but may produce slight erratic changes in frequency due to a rapid shift in the lamp parameters as the cathode glow changes location. Frequency variations are normally quite small and may be minimized by operation near the lamp's rated current.

Since all the above frequency changes are accompanied by changes in the firing and extinguishing voltages of the lamps the peak-to-peak voltage amplitude of the output will normally change as well.

Operating Environment of Lamps.

When designing glow lamps into oscillator circuits some consideration must be given to the environment in which the lamp is placed. In addition to the effects of temperature which have already been mentioned, other conditions which must be considered are the presence or absence of light or other external ionizing source and the action of stray fields upon the lamp.

The speed of ionization of the gas in a lamp depends on the state of the gas at the time voltage is applied to the lamp. If a lamp is in complete darkness with no other ionizing source present the time for ionizing the gas may be relatively long. Thus, a lamp which is operated in the dark may have an entirely different frequency than it will have when operated in light. Several types of glow lamps have a radioactive additive in the neon gas to minimize this difference in lamp operating characteristics. However, for very stable and consistent operation, some source of light should be provided for the lamp. This light is easily obtained by the use of another neon lamp which is continuously conducting in the vicinity of the glow lamp being used as an oscillator.

Stray fields such as the 60 cycle AC fields from power lines may often affect the firing voltage of the lamp resulting in an output which will vary in both amplitude and frequency at the rate of the stray field. This interference may be effectively reduced by enclosing the lamp in a grounded metal container or wire mesh shield.

When the oscillator capacitance is of such a small value that the stray capacitance has an effect on the operating frequency it is recommended that the lamp be clamped firmly in place so that the lamp may not be moved and thus change the capacity shunting the lamp. This is particularly important when the stray capacitance is used as the only capacitance in the oscillator circuit which may be required when high operating frequencies are desired.

GLOW LAMP ASTABLE MULTIVIBRATOR

A second type of relaxation oscillator which employs neon glow lamps is the astable or free-running multivibrator. The normal configuration employs two glow lamps with associated resistors and capacitors. The frequency or repetition rate is again determined by the operating characteristics of the lamps, the external resistance and capacitance, and the supply voltage. The upper frequency limit of the multivibrator is generally about 10 kilocycles per second. Several types of output waveforms are obtainable from the glow lamp multivibrator.

The basic multivibrator configuration is shown in Figure 2.19. The oper-

ation of the multivibrator will first be described and the equation for the operating frequency will then be obtained.



Fig. 2.19. Typical Glow Lamp Astable Multivibrator and Outputs.

As the supply voltage is applied to the circuit of Figure 2.19 the voltage across the two glow lamps begins to increase as the stray capacitances paralleling the lamps charge up. The firing voltage of one of the lamps will be reached first, since it is unlikely that both will reach their firing potentials at exactly the same time. Assuming that the firing voltage of N1 is reached first, as the lamp fires the voltage across it decreases suddenly to the lamps maintaining voltage and this drop is coupled to the anode of N2 by means of the capacitor. This negative going pulse is approximately equal to the difference between the firing voltage and the maintaining voltage of N1. The pulse which is coupled to N2 decreases the potential across that lamp thus preventing it from firing. At this time the potential across N1 is approximately equal to the maintaining voltage.

The capacitor then begins to charge through the load resistor of N2 toward the supply voltage with a time constant of C times R_2 . As the capacitor charges, the voltage across N2 rises until it reaches the firing potential of the lamp, at which time the lamp fires, decreasing the potential across N2 to the maintaining voltage. This sudden decrease in voltage is then coupled to N1 through the capacitor, dropping the voltage across N1 below the extinguishing voltage and hence N1 switches to the high resistance state and stops glowing. The capacitor then begins to charge in the reverse direction and the cycle repeats.

Figure 2.19 shows the outputs from the two lamps for a typical low frequency astable multivibrator.

In order to determine the equation for the oscillating frequency of the multivibrator, a single period is divided into two parts corresponding to the two different states of each lamp. Figure 2.20(a) shows the condition where N2 is fired and N1 is non-conducting—corresponding to time T_1 , and Figure 2.20(b) shows the condition where N1 is fired and N2 is non-conducting—corresponding to time T_2 .

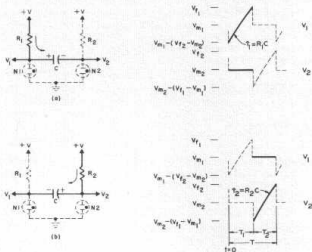

Fig. 2.20. Single Cycle of Output Waveforms

For the period T_1 the equation for the voltage v_1 is:

$$v_1(t) = V_{m1} - (V_{f2} - V_{m2}) + [V - V_{m1} + (V_{f2} - V_{m2})] (1 - e^{-\frac{t}{R_1 C}}) \quad 0 < t < T_1 \quad (2.18)$$

At $t = T_1$:

$$V_{f1} = V_{m1} - V_{f2} + V_{m2} + (V - V_{m1} + V_{f2} - V_{m2}) (1 - e^{-\frac{T_1}{R_1 C}}) \quad (2.19)$$

Solving for T_1 :

$$T_1 = R_1 C \ln \frac{V + V_{f2} - V_{m1} - V_{m2}}{V - V_{f1}} \quad (2.20)$$

where \ln is the natural logarithm.

Similarly:

$$T_2 = R_2 C \ln \frac{V + V_{f1} - V_{m1} - V_{m2}}{V - V_{f2}} \quad (2.21)$$

Then the period T is equal to the sum of the individual times T_1 and T_2 . Therefore:

$$T = R_1 C \ln \frac{V + V_{f2} - V_{m1} - V_{m2}}{V - V_{f1}} + R_2 C \ln \frac{V + V_{f1} - V_{m1} - V_{m2}}{V - V_{f2}} \quad (2.22)$$

The frequency of operation may then be determined by taking the reciprocal of the period T . A more simplified equation for the frequency of oscillation may be obtained by assuming equal firing and extinguishing voltage for the two lamps. Thus if

$$V_{f1} = V_{f2} = V_f \text{ and } V_{m1} = V_{m2} = V_m$$

then

$$T = R_1 C \ln \frac{V + V_f - 2V_m}{V - V_f} + R_2 C \ln \frac{V + V_f - 2V_m}{V - V_f} \quad (2.23)$$

or

$$T = C(R_1 + R_2) \ln \frac{V + V_f - 2V_m}{V - V_f} \quad (2.24)$$

Then the frequency of oscillation is the reciprocal of the period so that:

$$f = \frac{1}{C(R_1 + R_2) \ln \frac{V + V_f - 2V_m}{V - V_f}} \quad (2.25)$$

For the condition where equal load resistors are used $R_1 = R_2 = R$. Then:

$$f = \frac{1}{2RC \ln \frac{V + V_f - 2V_m}{V - V_f}} \quad R_1 = R_2 = R \quad (2.26)$$

The output waveform of Figure 2.19 is not the typical "square-wave" signal generally encountered in multivibrators. However, this multivibrator circuit may be modified to produce output signals which do have the general rectangular shape. A form of this modified circuit is shown in Figure 2.21 with waveforms taken at both the anode and cathode of one of the lamps. The anode voltage is approximately 30 volts peak-to-peak and the cathode square-wave output is approximately 4 volts peak-to-peak at a frequency of 15 cps. The magnitude of the square-wave output is dependent upon the value of the resistance in the cathode leads of Figure 2.21. As the resistance is made larger the output becomes greater; however, the top of the square-wave becomes more sloping and for very large values of cathode resistance the circuit can not be made to oscillate.

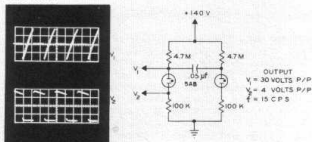

Fig. 2.21. Modified Multivibrator and Outputs.

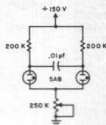

Fig. 2.22. Glow Lamp Multivibrator with Common Cathode Resistance.

Figure 2.22 shows another form of glow lamp multivibrator with a common cathode resistance. The frequency of oscillation is varied as the potentiometer is varied thus providing a method of frequency adjustment. The voltage waveform across the common cathode resistor is a sawtooth signal with a frequency of twice the anode signal.

The operation of glow lamp multivibrators is not as predictable as the operation of the sawtooth oscillator. The values of resistance, capacitance, and supply voltage are more critical in the operation of the multivibrator and for the higher frequencies of oscillation the supply voltage becomes particularly critical. The result is that even though the frequency of operation may be closely predicted by use of the equations in this section, any particular circuit may require changes in the parameters in order to obtain the desired output waveforms and frequency.

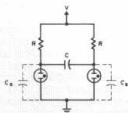

Fig. 2.23. Basic Multivibrator Showing Stray Capacitances.

In general, the glow lamp multivibrator is reliable for frequencies below about 2000 cps. The major requirement is that the load resistance is not so large that secondary sawtooth oscillations occur. The basic multivibrator circuit is redrawn in Figure 2.23 showing the stray capacitances across the lamps. Note that each lamp considered alone with its load resistor and stray capacitance forms a basic sawtooth oscillator. Figure 2.24 shows a circuit in which the large values of resistance have resulted in unwanted oscillations superimposed upon the desired low frequency. The low frequency is approximately 1 cps and the high frequency oscillations are approximately 1000 cps.

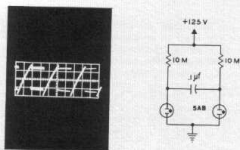

Fig. 2.24. Undesired Oscillations Resulting from Too Large Values of Load Resistor.

Difficulties with unwanted oscillations may normally be avoided if the load resistance is kept below one megohm and care is taken to minimize the stray capacitances shunting the glow lamps.

As mentioned previously, stable frequencies greater than about two kilocycles per second are usually obtained only when the proper values of resistance, capacitance, and supply voltage are found experimentally. The higher the desired frequency becomes, the more difficult it is to obtain the desired output and the value of the supply voltage in particular becomes quite critical. As before, consideration must be made of the size of the load resistance. Figure 2.25 shows a typical medium frequency circuit and outputs in which the value of load resistance is of a proper value to eliminate secondary oscillations.

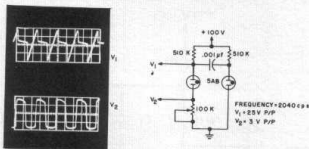

Fig. 2.25. Glow Lamp Multivibrator.

When using glow lamps in multivibrator circuits the normal precautions of providing sufficient external ionizing sources and proper shielding should be observed for best operation. The multivibrator circuit will perform in essentially the same manner as the sawtooth oscillator in so far as the effects of temperature, drift, radiation, etc.

APPLICATIONS

This section will describe a few of the many possible applications for the glow lamp in relaxation oscillator circuits.

The Electronic Organ

Electronic organs have presented an interesting glow lamp application

in which the lamps are used as tone generators. A number of glow lamp sawtooth oscillators are used in frequency divider chains where the frequency of each oscillator is divided by two, corresponding to an octave change, and is synchronized by either a master oscillator or by some preceding oscillator. Generally the highest frequency glow lamp oscillator in a particular chain is synchronized by the master oscillator which is normally a vacuum tube or transistor circuit. The following glow lamp oscillators in each chain are then stepped down to one-half the frequency of the preceding oscillator. Synchronization of each oscillator is required since unsynchronized glow lamp oscillators do not have the degree of stability required for organs.

One type of synchronization which has been used successfully in organ applications is shown in part in Figure 2.26. The sawtooth oscillator is composed of two glow lamps with resistor R_1 and capacitor C_1 as the main frequency determining elements. The synchronizing signal is fed to the common terminal of lamps N1 and N2, thus offering a high impedance to the sync signal. Capacitor C_1 has a value approximately one-tenth the value of C_2 so that the total capacitance of the branch composing C_1 and C_2 is approximately equal to C_1 . The output signal at frequency $f_0/2$ is thus reduced by a factor, $\frac{C_1}{C_1 + C_2} \approx 0.1$. Capacitors C_3 and C_4 form a voltage dividing network for the sync signal of the following stage. The values of capacitors C_3 and C_4 are about equal and the total capacitance of the branch composed of C_3 and C_4 is much less than the value of C_1 ; therefore, C_3 and C_4 have a negligible effect on the frequency determining units. The following stage is synchronized by the sharp negative pulse as the capacitors discharge through the glow lamps N1 and N2. The configuration of the capacitive network has the added advantage that the pulse generated across lamp N4 when it fires is greatly attenuated in the back transmission path to the output at

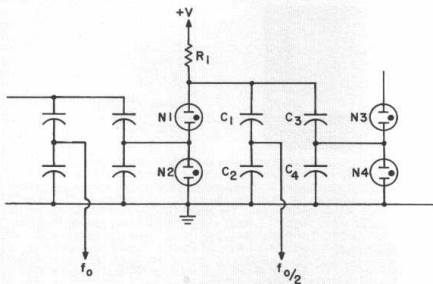

Fig. 2.26. Basic Configuration of Frequency Dividing Tone Generator.

$f_0/2$ so that a negligible amount of the signal from one oscillator is coupled back to the preceding output.

The free-running unsynchronized-frequency of each oscillator is adjusted for a frequency slightly lower than one-half the frequency of the preceding oscillator so that synchronization may be accomplished.

A circuit which divides by four is shown in Figure 2.27. The synchronizing signal is a sine wave obtained from a low impedance source. The first oscillator stage consists of a single glow lamp with the synchronizing signal injected across a 20 kilohm resistor in the cathode lead. The lamp is paralleled by a 5.6 megohm resistor experimentally chosen to obtain the proper frequency for the first oscillator.

The next two stages perform the frequency division. Each stage consists of two glow lamps in the sawtooth oscillator configuration described previously.

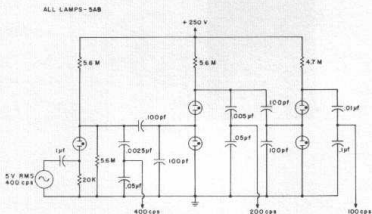

Fig. 2.27. Typical Frequency Dividing Chain.

With an input sine wave synchronizing signal of five volts RMS the output frequency was stable over a range of 69 to 110 cycles per second, thus providing a wide frequency range for adjustments when required.

For a more complete description of the glow lamp tone generators and the associated circuits used in the electronic organ the reader is referred to the reference listed at the end of the chapter.

Variable Frequency-Variable Pulse Width Generator

Figure 2.28 shows a circuit in which a glow lamp astable multivibrator is used to furnish a square wave output of variable frequency and variable pulse width. Very low repetition rates may be obtained from the generator. For the component values as shown in Figure 2.28 the accompanying wave-shapes were obtained at a nominal repetition rate of 220 pulses per second.

The 500 kilohm potentiometer with the center arm to the supply voltage provides the variable pulse width with essentially no change in frequency when the lamp firing and extinguishing voltages are somewhat matched. The frequency of oscillation may be varied by changing the value of C or the supply voltage or both. The output is obtained from a 50 kilohm potentiometer which thus provides a variable amplitude output with a maximum of about 5 volts peak. The diode network is used to flatten the top of the pulse which normally may have a decided slope. This diode network may be eliminated depending on the particular application.

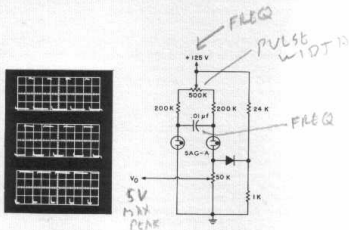

Fig. 2.28. Square Wave Generator.

Time Delay Relays

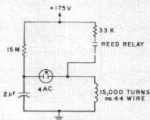

Fig. 2.29. Time Delay Relay.

Figure 2.29 shows a configuration in which a glow lamp is used to operate a relay after a time delay. After voltage is applied to the circuit the voltage across the capacitor begins to rise as in the normal manner of a sawtooth

generator. When the firing voltage of the lamp is reached the lamp fires allowing a flow of current to pass through the relay. With the components properly chosen the relay will then operate. A contact of the relay can be used to seal the relay in, thus providing a one-shot time delay relay.

In the circuit of Figure 2.29 a miniature reed relay is used. The coil is wound of 15,000 turns size 44 copper wire with a resistance of 3500 ohms. The time delay for the component values as shown is about 20 seconds.

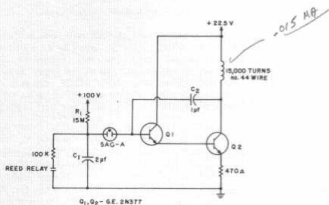

Fig. 2.30. Repetitive Time Delay Relay.

Figure 2.30 shows another type of time delay relay in which the relay cycles on an off instead of sealing in as did the relay of Figure 2.29. When the rising voltage across capacitor C_1 causes the glow lamp to fire the resultant current flow is amplified through transistors Q_1 and Q_2 and energizes the relay. The glow lamp quickly drops out of conduction thus placing a very high impedance between the R_1C_1 charging network and the transistor network. Capacitor C_2 then begins to discharge through the high input resistance of transistor Q_1 which causes the collector voltage of Q_2 to slowly rise. When the voltage across the relay reaches the dropout voltage the relay de-energizes and the cycle repeats.

If one contact of the relay is used to shunt C_1 the capacitor is not allowed to charge up while the relay is energized. In addition, the capacitor voltage is decreased to near zero potential thus resulting in a longer charge time.

For the circuit of Figure 2.30 employing the reed relay of Figure 2.29 the total cycle time is 55 seconds, with the relay energized for 15 seconds of the cycle time.

Alarm Circuit

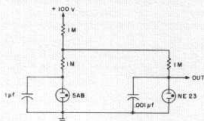

Fig. 2.31. Glow Lamp Audio Alarm Circuit.

By making use of two sawtooth oscillators with one modulating the other, a signal can be produced which may be used as an audio siren or alarm. Figure 2.31 shows one method employing this technique. The first neon oscillator oscillates at a low frequency and the output signal is used to modulate the supply voltage for the second oscillator which operates at a higher frequency. The varying audio frequency signal when used as an input to a speaker system gives the effect of a siren and may be used for alarm purposes.

Light Indicator

The output frequency of a glow lamp sawtooth oscillator is a function of the load resistance in series with the lamp and by varying this resistance the output frequency may be varied. Figure 2.32 shows a sawtooth oscillator employing a photoconductor as a variable resistance. Thus the output frequency of the oscillator is a function of the light incident upon the photoconductor, the resistance of the photoconductor decreasing for increasing light intensity. The variable frequency output may be used to provide a signal for a speaker system thus giving an audio indication of the light on the photoconductor.

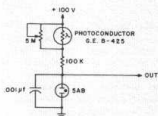

Fig. 2.32. Light Indicator.

By using a potentiometer to shunt the photoconductor, the starting conditions of the oscillator may be somewhat controlled. Thus the oscillator may be adjusted so that it will begin to oscillate only when a certain level of darkness surrounds the photoconductor. Also by proper selection of the photoconductor, resistance, capacitance, and supply voltage the lamp may be made to oscillate in the dark and not in the light, or alternately to oscillate in light and to cease oscillating in the dark. The output may then be used as a signal source for a speaker system which will give an audio indication of the absence or presence

of light in an area which may be inaccessible to the individual. A non-oscillatory circuit for sensing light levels will be described under Miscellaneous Applications in Chapter Four.

Temperature Indicator

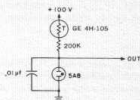

Fig. 2.33. Temperature Indicator.

In a manner similar to the light indicator above, a thermistor may be used as a variable resistance in a glow lamp oscillator circuit as shown in Figure 2.33. The thermistor has a resistance which decreases with increasing temperature. The frequency output of the oscillator is thus a function of the temperature of the environment in which the thermistor is placed and the signal may be used to indicate temperature either by direct frequency measurement or by using the output to provide a signal for a speaker system and thus giving an audio indication. Non-oscillatory circuits for sensing both temperature and humidity levels will be described in Chapter Four.

REFERENCE LIST

- "A Neon Counter for Medical Research", O.C. Gruner, *Electronics*, vol 17, December 1944, p 284.
- "Gas Diode Electronic Organ", R.M. Strassner, *Electronics*, January 1951, p. 70.
- "Neon Lamps as Circuit Elements", W.R. Kincheloe, Jr., Technical Report No. 10, Stanford University Electronics Research Laboratory, May 26, 1952.
- "Relaxation Oscillations in Voltage-Regulator Tubes", P.L. Edwards, *Proc. I.R.E.*, vol 41, December 1953, pp 1756-1760.
- "A Study of the Neon Bulb as a Nonlinear Circuit Element", C.E. Hendrix, *I.R.E. Transactions on Component Parts*, September 1956, pp 44-54.
- "Demonstration Neon Multivibrator", L.W. Orr, *Electronics*, June 1, 1957.
- "Neon Triode Gives Low-Speed Gate", R.L. Ives, *Electronics (Engineering Issue)*, March 14, 1958, pp 170-176.
- "Alarm System Uses Gated Neon Warbler", R.L. Ives, *Electronics (Engineering Issue)*, May 23, 1958, pp 74-77.
- "An Electronic Siren", E.H. Dingman, *Radio and TV News*, July 1958, p 111.
- "Kill Commercials Fast", O. Relling, *Radio-Electronics*, June 1959, pp 32-33.
- "Electronics Organ Uses Neon Tone Generators", R.H. Dorf, *Electronics (Engineering Issue)*, August 29, 1959, pp 36-41.
- "Neon Oscillator Rings", R.L. Ives, *Electronics (Engineering Issue)*, October 10, 1958, pp 108-115.
- "Novel Neon-Lamp Oscillators", M.S. Robbins, *Electronics World*, May 1960, p 59.
- "Electronics Organ Handbook", H.E. Anderson, Chapter 6, Howard W. Sams & Co., Inc., September 1960.

LOGIC AND COMPUTER APPLICATIONS OF GLOW LAMPS

CHAPTER 3

THE BINARY NUMBER SYSTEM AND LOGIC OPERATIONS

Before applying glow lamps to logic and computer systems some fundamentals of the binary number system and of logic operations will be given.

The Binary Number System

The use of two-level coding, commonly called binary coding, is the simplest way for uniquely labeling or describing a signal or event. Binary coding involves the use of two-level identifications such as "yes" and "no", "one" or "zero" ("1" or "0"), or two different voltage levels. The binary system is of value since it reduces information to a series of "yes" and "no" type representations; in fact, any question which has a definite answer can be answered by a certain number of "yes" and "no" replies if the questions are properly ordered and phrased.

In our familiar decimal number system a number is defined by the sum of each of its constituent numbers times 10 to the appropriate power. Thus:

$$1963 = 1 \times 10^3 + 9 \times 10^2 + 6 \times 10^1 + 3 \times 10^0 = 1000 + 900 + 60 + 3$$

(note: $10^0 = 1$)

This may also be thought of as 1 unit of thousands, 9 units of hundreds, 6 units of tens, and 3 units of ones. Likewise:

$$.638 = 6 \times 10^{-1} + 3 \times 10^{-2} + 8 \times 10^{-3} = .6 + .03 + .008$$

We refer to the decimal number system as a base ten system. The base of our number system also defines the number of multipliers (1, 9, 6, and 3 in the first example) which are taken times each power of ten. Thus in the decimal number system we are restricted to the ten numbers 0, 1, 2, 3, 4, 5, 6, 7, 8, 9.

The base two or "binary" number system utilizes the number 2 (instead of 10, as in the decimal system) taken to the appropriate power. Consequently the number of multipliers is limited to just 2 values — 0 and 1. A few examples of binary numbers will show the similarity to the decimal system.

$$10101 = 1 \times 2^4 + 0 \times 2^3 + 1 \times 2^2 + 0 \times 2^1 + 1 \times 2^0 \quad (\text{binary})$$
$$= 16 + 0 + 4 + 0 + 1 = 21 \quad (\text{decimal})$$

$$.1101 = 1 \times 2^{-1} + 1 \times 2^{-2} + 0 \times 2^{-3} + 1 \times 2^{-4} \quad (\text{binary})$$
$$= .5000 + .2500 + 0 + .0625 = .8125 \quad (\text{decimal})$$

$$11.01 = 1 \times 2^1 + 1 \times 2^0 + 0 \times 2^{-1} + 1 \times 2^{-2} \quad (\text{binary})$$
$$= 2 + 1 + 0 + .25 = 3.25 \quad (\text{decimal})$$

Note that the "binary point" separates the negative powers of two from the positive powers of two (including zero) just as the "decimal point" performs in our more familiar decimal number system.

Any decimal number may be converted to a binary number and vice versa. Therefore the normal mathematical operations of addition, subtraction, multiplication, and division may be performed on binary numbers in the same manner

as for decimal numbers. An example of each operation in both systems will show the similarity.

Addition:

| | | | | | | | |
|---------|---|--|--|---------|----|--|------------------|
| binary | $\begin{array}{r} 10100 \\ + 101 \\ \hline 11001 \end{array}$ | | <table style="margin-left: auto; margin-right: auto;"> <tr> <td style="text-align: right;">decimal</td> <td style="text-align: left;">20</td> </tr> <tr> <td></td> <td style="text-align: left;">$\frac{+ 5}{25}$</td> </tr> </table> | decimal | 20 | | $\frac{+ 5}{25}$ |
| decimal | 20 | | | | | | |
| | $\frac{+ 5}{25}$ | | | | | | |

Note that $1 + 1 = 10$ (read as one zero) representing 1 unit of two and 0 unit of one.

Subtraction:

| | | | | | |
|------------------|--|--|---|----|------------------|
| | $\begin{array}{r} 10100 \\ - 101 \\ \hline 1111 \end{array}$ | | <table style="margin-left: auto; margin-right: auto;"> <tr> <td style="text-align: right;">20</td> </tr> <tr> <td style="text-align: left;">$\frac{- 5}{15}$</td> </tr> </table> | 20 | $\frac{- 5}{15}$ |
| 20 | | | | | |
| $\frac{- 5}{15}$ | | | | | |

Note that when a "unit" is borrowed from the adjacent column, it is two which is borrowed, rather than ten, as in the decimal system.

Multiplication:

| | | | | | |
|------------------------|--|--|---|----|------------------------|
| | $\begin{array}{r} 10100 \\ \times 101 \\ \hline 10100 \\ 00000 \\ 10100 \\ \hline 1100100 \end{array}$ | | <table style="margin-left: auto; margin-right: auto;"> <tr> <td style="text-align: right;">20</td> </tr> <tr> <td style="text-align: left;">$\frac{\times 5}{100}$</td> </tr> </table> | 20 | $\frac{\times 5}{100}$ |
| 20 | | | | | |
| $\frac{\times 5}{100}$ | | | | | |

Division:

| | |
|---|---|
| $10100 + 101 = 100$ $\begin{array}{r} 100 \\ 101 \overline{) 10100} \\ \underline{101} \\ 000 \end{array}$ | $20 \div 5 = 4$ $\begin{array}{r} 4 \\ 5 \overline{) 20} \\ \underline{20} \end{array}$ |
|---|---|

Notice that as we have lowered the base of our number system from 10 to 2 we have at the same time increased the number of characters necessary to define a number. For example, while we require only 3 places in the decimal system to define decimal 100 we now require 7 places in the binary system. Why, then, is such extensive use made of the binary system in the digital computer?

The answer is that there are a number of electrical and mechanical components such as glow lamps, diodes, and switches which are basically two state devices capable of being quickly and accurately switched from one state to the other. Higher state devices, such as three level devices, are not so readily obtained and are increasingly more difficult to control. In addition a "yes" and "no" type system of information is the simplest way for uniquely describing a signal or event. Thus the most common basic number system used in digital computers and logic operations is the binary or two-state number system.

Fundamental Logic Operations

The three basic functions involved in logic operations are defined as AND, OR, and NOT operations. The inputs and outputs will symbolically be given as capital letters (A, B, C, etc.). In general, to show the state of the input and output, the numbers "1" and "0" will be used, where a "1" indicates the presence of a signal and a "0" indicates the absence of a signal. The notation used for these functions and their definitions are listed in Figure 3.1 (a).

| | |
|-------------------------|---------------------------|
| A, B, C, etc. | Symbols Used In Equations |
| $AB, A \cdot B, (A)(B)$ | A and B |
| $A + B$ | A or B |
| \bar{A} | Not A |
| 1 | "True" or "On" |
| 0 | "False" or "Off" |

(a) DEFINITIONS

| | |
|--------------------------|--|
| Commutative Laws | $A + B = B + A, AB = BA$ |
| Associative Laws | $(A + B) + C = A + (B + C), (AB)C = A(BC)$ |
| Distributive Law | $A(B + C) = AB + AC$ |
| Special Distributive Law | $(A + B)(A + C) = A + BC$ |
| De Morgan's Theorem | $\overline{A + B} = \bar{A}\bar{B}, \overline{AB} = \bar{A} + \bar{B}$ |

(b) LAWS

| | |
|-------------------------|-----------------------|
| $1 = \bar{0}$ | $0 = \bar{1}$ |
| $A + A = A$ | $A \cdot A = A$ |
| $A + 1 = 1$ | $A \cdot 1 = A$ |
| $A + \bar{A} = 1$ | $A \cdot \bar{A} = 0$ |
| $\bar{\bar{A}} = A$ | |
| $A + AB = A(1 + B) = A$ | |

(c) RELATIONSHIPS

Fig. 3.1. Logic Definitions and Boolean Algebra.

As will be seen shortly logic functions may be represented in equation form and algebraic operations performed on these equations. The mathematics pertaining to these operations is classified as Boolean algebra. Although no attempt to instruct in Boolean algebra will be made here, a summary of the main rules used in this branch of mathematics is listed in Figure 3.1 (b). In addition there are a number of relationships listed in Figure 3.1 (c) which aid in simplifying logic equations. The reader is referred to the reference list at the conclusion of this chapter for texts on the subject.

The manner in which logic operations are formulated and reduced may best be illustrated by an example. Suppose that we desire to use a logic system to automatically control the time during which a lawn sprinkler is in operation. Let X denote the output of our logic operation with the value 1 denoting that the sprinkler is to turn on or stay on and the value 0 to denote that the sprinkler is to be turned off or stay off.

Let us use the following conditions for determining when the sprinkler is to be operated:

The first condition is that we desire the sprinkler to operate between the hours of 6 PM and 8 PM. Then let the variable A be a 1 during these hours of the day

and a 0 for all other hours of the day. In a practical system a timing device could be used to provide 2 inputs dependent upon the above conditions.

Since it is generally not desired to water a lawn while it may be raining let the variable B be a 1 if it is raining and a 0 if it is not raining. Some type of rain detector will provide the input B.

To provide a manual operation let variable C be a 1 when placed in manual operation and a 0 for automatic operation. If it rains while in manual operation the sprinkler system should turn off.

Finally let a fourth variable D operate from an on-off switch so that a 1 places the system in operation, either manual or automatic, and a 0 will stop the system from working.

There are thus four variables in the logic problem. In order to determine the state of the output for each of the possible input conditions a "truth-table" is made. In the truth-table shown in Figure 3.2 for the above problem each of the 16 possible arrangements of the four variables is shown and the desired output for each condition is listed in the column X.

With the truth-table obtained, the logic equation for the system may be written down. For each output which is a 1 the four variables are written down with the AND operation connecting them. If a variable is a 1 the letter is written directly, if the variable is a 0 the letter is written as a NOT. Thus for row four of the truth-table of Figure 3.2 we obtain $\bar{A}BCD$.

| A | B | C | D | X |
|---|---|---|---|---|
| 0 | 0 | 0 | 0 | 0 |
| 0 | 0 | 0 | 1 | 0 |
| 0 | 0 | 1 | 0 | 0 |
| 0 | 0 | 1 | 1 | 1 |
| 0 | 1 | 0 | 0 | 0 |
| 0 | 1 | 0 | 1 | 0 |
| 0 | 1 | 1 | 0 | 0 |
| 0 | 1 | 1 | 1 | 0 |
| 1 | 0 | 0 | 0 | 0 |
| 1 | 0 | 0 | 1 | 1 |
| 1 | 0 | 1 | 0 | 0 |
| 1 | 0 | 1 | 1 | 1 |
| 1 | 1 | 0 | 0 | 0 |
| 1 | 1 | 0 | 1 | 0 |
| 1 | 1 | 1 | 0 | 0 |
| 1 | 1 | 1 | 1 | 0 |

| | | |
|---|---|---------------------------|
| A | 1 | 6PM to 8PM - Desired Time |
| | 0 | Other Hours |
| B | 1 | Raining |
| | 0 | Not Raining |
| C | 1 | Manual Operation |
| | 0 | Automatic Operation |
| D | 1 | System On |
| | 0 | System Off |
| X | 1 | Sprinkler On |
| | 0 | Sprinkler Off |

Fig. 3.2. Truth-Table for Sample Problem.

Each row with an output of 1 is then connected together with an OR operation. Thus the logic equation for the truth-table of Figure 3.2 is:

$$X = \bar{A}BCD + A\bar{B}\bar{C}D + A\bar{B}CD \tag{3.1}$$

The next step is to reduce the equation, if reducible, to a more simple form. One method of reducing is to use the laws and relationships of Figure 3.1. For other methods of reducing Boolean equations the reader is referred to the references listed at the end of the chapter.

One reduction of equation 3.1 would be the following:

$$X = (\bar{A}\bar{B}C + A\bar{B}\bar{C} + A\bar{B}C) D \quad (3.2)$$

$$= (\bar{A}C + A\bar{C} + AC) \bar{B}D \quad (3.3)$$

$$= [\bar{A}C + A(C + \bar{C})] \bar{B}D \quad (3.4)$$

$$= (\bar{A}C + A \cdot 1) \bar{B}D \quad (3.5)$$

$$X = (\bar{A}C + A) \bar{B}D \quad (3.6)$$

The final equation may now be described by a schematic diagram showing the ordering of the logic operations in the problem. One type of schematic diagram is shown in Figure 3.3 for equation 3.6. In general, several forms of a logic equation may be obtained and the final form chosen is that which is most compatible with the circuitry or equipment which will perform the logic operation. The next step then is to obtain the circuits which will perform the logic operations.

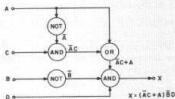

Fig. 3.3. Block Diagram for Logic Equation of Sample Problem

LOGIC CIRCUITS EMPLOYING GLOW LAMPS

The operating characteristics of the glow lamp make it an ideal device in logic circuits where high speed of operation is not important. The power consumption of these logic circuits is small and in addition the circuits may be constructed at very low cost. The circuits may be designed so that small changes occurring in the operating characteristics of the lamp will have essentially no effect on the operation of the logic circuit. In addition the operation of these logic circuits is generally insensitive to small changes in the supply voltages. This section will discuss the use of the glow lamp in AND and OR gates and then combine these glow lamp logic circuits with conventional NOT circuits to result in workable logic operations.

Glow Lamp AND Gate

Figure 3.4 shows the basic configuration for a glow lamp AND gate with two inputs. The supply voltage is chosen to be larger than the firing voltage of either lamp so that with the inputs A and B at ground potential one of the lamps will be conducting holding the output voltage V_o at the maintaining voltage of the conducting lamp. Normally the conducting lamp will be the lamp which has the lowest firing voltage. The normal operation of the AND gate results in a rising output signal only when both of the input voltages rise.

Two slightly different modes of operation exist for the AND gate depending on the magnitude of supply voltage. Consider first the case where the supply voltage is only slightly in excess of the breakdown of one of the lamps. Referring to Figure 3.5 assume a supply voltage of +80 volts with $V_{F1} = 75$ volts,

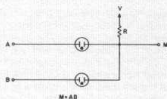

Fig. 3.4. Typical 2-Input "AND" Gate.

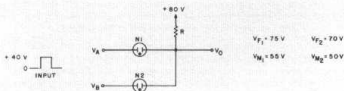

Fig. 3.5. "AND" Gate.

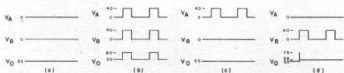

Fig. 3.6. "AND" Gate Waveforms.

$V_{M1} = 55$ volts, $V_{F2} = 70$ volts, $V_{M2} = 50$ volts and a two-state, input square wave signal of 0 or +40 volts. Also assume that the extinguishing voltage of each lamp is equal to the maintaining voltage.

With both inputs at zero the output will be low at the maintaining voltage of the lamp with the lowest breakdown voltage. The other lamp will thus be held in the non-conducting state since the voltage across it is insufficient to cause firing. This condition is shown in Figure 3.6a. If both inputs now rise together to +40 volts the voltage across each lamp will be reduced to 40 volts which is less than the extinguishing voltage of each lamp. The lamps will therefore stop

conducting and the output voltage will rise to the supply voltage of +80 volts. Thus with V_A and V_B both equal to +40 volts the AND gate will give an output pulse of 30 volts above the quiescent level. This case is shown in Figure 3.6b.

Consider now the cases where $V_A \neq V_B$. If $V_A = +40$ volts and V_B remains at zero volts the output voltage V_o remains at +50 volts due to the clamping action of the already conducting lamp N2. Therefore N1 will remain non-conducting, N2 will remain conducting, and the output voltage will remain at +50 volts as shown in Figure 3.6c. If $V_A = 0$ volts and V_B rises to +40 volts a different result will be obtained since lamp N2 is assumed to be the originally conducting lamp. This situation is shown in Figure 3.6d. As V_B begins to rise V_o also begins to rise since N2 is conducting. When V_B has risen to the +30 volt level the voltage across N2 will be at the extinguishing voltage and N2 will stop conducting. The output voltage will then start to rise toward the supply voltage but when the firing voltage of N1 is reached it will fire, thus quickly dropping the output to the maintaining voltage of N1. As V_B falls back to zero the output voltage will remain at +55 volts and now lamp N1 is in the conducting state.

Thus an error signal of 5 volts is produced due to the difference in maintaining voltages of the two lamps. In many cases this error signal will be small enough so that it will not give a false output indication. However if the error signal is of a level which cannot be tolerated the error may be minimized by matching the lamps of the AND circuit or by using the following method.

It will be noticed in Figure 3.6d that a second pulse does not result in a further error in the output. In fact all four outputs are correct but of different amplitudes for the second pulse and all following pulses as well. Therefore if two or more pulses make up the input signal to the AND gate, the first pulse may be considered to be a "set" pulse and the second pulse to produce the desired output. Thus one method of compensating for the signal error introduced because of the lamp characteristics is to use an input signal of two pulses with the second pulse performing the logic operation. This method will result in a reduction of one-half

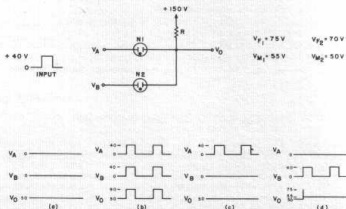

Fig. 3.7. Waveforms for "AND" Gate with Large Supply Voltage

in the available operations per second of a logic system; however, since glow lamp logic circuits are essentially low speed systems this will normally be of no consequence.

The output signal for the previous AND gate is the difference between the supply voltage and the maintaining voltage of the conducting lamp. Hence the output signal amplitude may vary as the supply voltage varies. In addition, since it is possible that either lamp may be initially conducting, the amplitude of the output signal will depend upon which lamp is conducting. The variations in output voltage may be minimized by operating the AND gate from a higher supply voltage.

Consider that the same lamps of Figure 3.5 are being used with a supply voltage much greater than the firing voltage of the lamps—for example, 150 volts. The operation of this AND gate will now be considered with the voltage waveforms shown in Figure 3.7.

With both inputs at zero potential the output will be clamped to the maintaining voltage of one of the lamps. As before, consider that the lamp with the lowest firing voltage is initially in the conducting state with the other lamp non-conducting.

Now if both inputs rise to +40 volts the voltage across the conducting lamp will not fall below the extinguishing voltage of the lamp and the lamp thus remains conducting and passes the input pulse through the lamp to the output with essentially no change in amplitude or shape of the input signal. This case is shown in Figure 3.7b. The other lamp will remain non-conducting since the voltage across it remains essentially equal to the maintaining voltage of the conducting lamp.

For this case where the supply voltage is large the output pulse will be of the same amplitude as the input pulse to the conducting lamp regardless of which lamp is conducting. In addition the output voltage amplitude is independent of supply voltage to the extent that the voltage does not decrease to a value such that the conducting lamp will extinguish for an input pulse. The condition imposed on the supply voltage and input signal amplitude is thus:

$$V > V_{in} + V_E \quad (3.7)$$

where V is the supply voltage, V_{in} is the amplitude of the input pulse above ground potential and V_E is the extinguishing voltage of the conducting lamp.

If V_A now rises to +40 volts with V_B at zero potential the output V_o will stay clamped to the maintaining voltage of N2 since N2 is assumed to be initially conducting. Thus there will be no output signal as shown in Figure 3.7c.

The condition existing for $V_A = 0$ and V_B rising to +40 volts is the same as for the AND gate of Figure 3.5 with the lower supply voltage. The output voltage rises quickly with the input until the firing voltage of N1 is reached after which N1 switches to the conducting state and the output voltage drops to the maintaining voltage of N1 as shown in Figure 3.7d.

With a repetitive pulsed input signal, where the AND gate is insensitive to normal supply voltage variations and the difference in maintaining voltages of the lamps, an error signal still exists in the output for the case shown in Figure 3.7d. Therefore, an input signal consisting of two or more pulses, with the first pulse being a "set" pulse, is advised when necessary for proper operation of the AND gate.

In designing the AND gate the voltages must be considered as well as the

value of load resistance R . For the second type of AND gate the following conditions are imposed on the voltages:

$$V_{in} > V_{F1} - V_{M2}, \quad V_{in} > V_{F2} - V_{M1} \quad (3.8)$$

$$V > V_{in} + V_E \quad (3.9)$$

where V_{in} is the input pulse amplitude above ground potential, V_F , V_M , and V_E are the firing, maintaining and extinguishing voltages respectively, and V is the supply voltage.

Equation 3.8 is required to assure that the first pulse sets the AND gate properly.

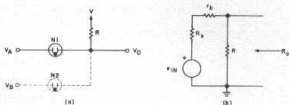

Fig. 3.8. Equivalent Circuit of Glow Lamp "AND" Gate.

The minimum value of load resistance depends on the maximum current the lamps can carry. In general it is best to have the load resistance small since the glow lamp tends to be more stable for currents near its rated value. To determine the effect of the load resistance on the output impedance of the AND gate consider that lamp N1 of Figure 3.8a is the conducting lamp. The AC equivalent circuit for the gate with N1 conducting is shown in Figure 3.8b. R_a is the internal resistance of the driving source and r_b is the AC resistance of the conducting glow lamp. From the equivalent circuit it is seen that the output impedance of the AND gate is the parallel combination of R and $R_a + r_b$ so that:

$$R_o = \frac{R(R_a + r_b)}{R + R_a + r_b} \quad (3.10)$$

To obtain an idea of the magnitude of output impedance expected for an AND gate assume $R_a = 10K$, $R = 200K$ and $r_b = 5K$.

Then:

$$\begin{aligned} R_o &= \frac{200(10 + 5)}{200 + 10 + 5} \times 10^3 \\ &= 14K \end{aligned}$$

Glow Lamp OR Gate

Figure 3.9 shows the basic 2-input glow lamp OR gate. The OR gate function is to give an output when there is an input signal at either or both of the inputs.

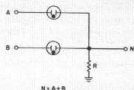

Fig. 3.9. Basic Glow Lamp "OR" Gate with Two Inputs.

The input signal to the basic OR gate must be greater than the firing voltage of each lamp. With an input greater than the firing voltage the lamp will conduct and the output voltage will then be the difference between the input voltage and the maintaining voltage of the conducting lamp. Using the same lamps as for the AND gate of Figure 3.5 the output waveforms for an OR gate with an input pulse of +100 volts are shown in Figure 3.10. Note that when the input pulse is present at both inputs the lamp with the lowest firing potential will fire and the other lamp will remain non-conducting. Therefore, in this case, the output voltage will be the difference between the input voltage and the maintaining voltage of the lamp with the lowest firing voltage.

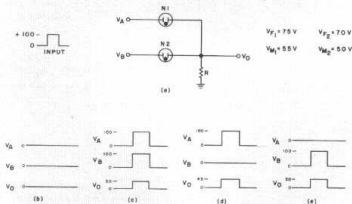

Fig. 3.10. Waveforms for Basic 2-Input "OR" Gate.

From the waveforms of Figure 3.10 it is seen that the output voltage in all cases is less than the input voltage. A circuit which minimizes this loss in voltage is shown in Figure 3.11. The negative bias voltage V_1 must be less than the extinguishing voltage of each of the lamps so that a lamp does not remain

conducting after an input pulse. With the bias voltage present the lamps will fire at a lower input voltage and thus only a small amount of the input signal amplitude is lost in transmission through the gate. In addition the input voltage need not be as large as for the OR gate of Figure 3.9 where the input voltage amplitude had to exceed the firing voltage of the lamps.

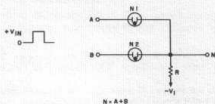

Fig. 3.11. Modified Glow Lamp "OR" Gate.

The design conditions for the modified OR gate of Figure 3.11 are:

$$|V_1| < V_{E1}, |V_1| < V_{E2} \quad (3.11)$$

$$V_{in} > V_{F1} - |V_1|, V_{in} > V_{F2} - |V_1| \quad (3.12)$$

where V_F and V_E are the firing and extinguishing voltages respectively.

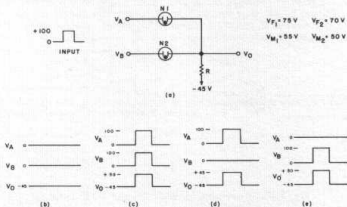

Fig. 3.12. Waveforms for Modified 2-Input "OR" Gate.

The waveforms for the modified OR gate with an input of +100 volts and a bias voltage of -45 volts are shown in Figure 3.12. The magnitude of the output pulse above the quiescent value is given by the equation:

$$V_o = V_{in} - (V_M - V_I) \quad (3.13)$$

A look at the AC equivalent circuit of the OR gate will show it to be identical to the AND gate. Thus the output impedance of the OR gate is the same as that of the AND gate with the value obtained by equation 3.10.

NOT Circuits

The NOT logic function is performed by inverting the input signal and then restoring the voltage level at the output. Three types of NOT circuits which may be used with glow lamp AND and OR gates are shown in Figure 3.13. The transistor inverter of Figure 3.13c is the most commonly used circuit and is generally compatible with glow lamp logic circuits. The transistor operates in an on-off manner being either in saturation or cutoff depending upon the input signal.

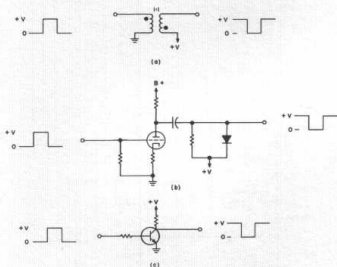

Fig. 3.13. "NOT" Circuits.

Designing Glow Lamp Logic Circuits

After the truth-table and logic equation have been obtained for a particular logic problem the block diagram may be drawn and the proper interconnections made between the various logic blocks to be used. At this point it must be determined whether the logic system will be direct-coupled or AC coupled. If the input signals seldom change it will be necessary to design a direct coupled logic system. However if the input consists of pulses the logic system may be either direct or AC-coupled depending on the designer's choice and the complexity of the logic problem.

In direct-coupled logic circuits one network will be directly connected to other networks. This involves a consideration of the DC voltages in one network and how the adjacent networks must be matched to it so that the complete system will work properly. The DC logic system generally becomes more complex as the number of logic functions increases. Due to the necessity of properly matching voltage levels between the separate blocks the number of different supply voltages required may become quite large. In general, logic systems composed of only a few functions are very readily designed with direct coupling and fewer components are required than for the normal AC logic system.

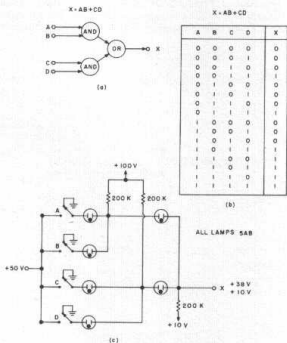

Fig. 3.14. Glow Lamp Logic Circuit (Direct-Coupled).

Figure 3.14 shows a functional diagram, truth-table, and circuit diagram for a logic system which is direct coupled. The inputs to the system are either zero or +50 volts depending on the switch position and the output is either +10 volts or approximately +38 volts. Thus at the input a "1" is +50 volts and a "0" is zero volts, while at the output a "1" is +38 volts and a "0" is +10 volts. For this example no attempt was made to restore the output to the same voltage

levels as the input. The range and values of the output signal is generally determined by the use to be made of the output.

In AC coupled logic circuits the main concern is to couple between blocks with a minimum of distortion and loading of the signal. The normal coupling circuit consists of a capacitor and a resistor if needed. In AC coupled systems there is not the need for a large number of supply voltages since generally one voltage is sufficient for all AND gates, one voltage for all OR gates, and one voltage for all NOT circuits.

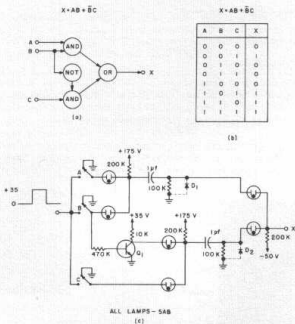

Fig. 3.15. Glow Lamp Logic Circuit (AC Coupled).

Depending upon the frequency and duty cycle of the input signal diode clamping may be required. For low duty cycle inputs diode clamping is generally not needed in the coupling network. However, when signals of a relatively high frequency are used it may be necessary to employ clamping to restore the signal to its original level.

Figure 3.15 shows the block diagram, truth-table, and AC coupled logic circuit for a 3-input system. Diodes D_1 and D_2 are indicated for inclusion if

clamping is necessary. The main criteria for determining transistor Q_1 is that the voltages across the transistor terminals do not exceed the rated values. Either PNP or NPN transistors may be used depending upon the voltage and signal polarities of the system. For the circuit of Figure 3.15 an input voltage of 35 volts peak resulted in an output voltage of about 28 volts peak.

Although the AND and OR gates of these examples have only two inputs there is essentially no limit to the number of inputs possible. For example, Figure 3.16 shows a five input AND gate and a three input OR gate.

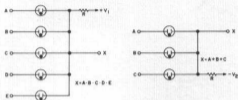

Fig. 3.16. "AND" and "OR" Gates with Multiple Inputs.

RESPONSE OF GLOW LAMP CIRCUITS TO PULSE INPUTS

The inputs to logic gates are typically square waves with relatively fast rise and fall times. Due to the ionization and deionization of the neon gas in the glow lamp the frequency of the input pulses is normally less than about 5 KC.

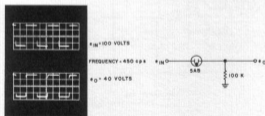

Fig. 3.17. Glow Lamp Square Wave Response.

Figure 3.17 shows the results of driving a glow lamp with a 100 volt positive square wave at a frequency of 450 cps. Notice that the circuit is similar to an OR gate — the difference being, of course, that only one lamp and one input are being used.

The load resistor in this case is 100,000 ohms so that for an output signal of 40 volts the peak current flowing through the lamp is about .4 milliamp. The leading and trailing edges of the input and output signals are shown in more detail in Figure 3.18. The fall time of the output signal is approximately the same as the input, being on the order of 5 microseconds.

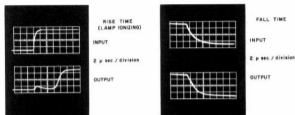

Fig. 3.18. Leading and Trailing Edges of Square Wave Response.

The upper waveshapes of Figure 3.18 show the rise time of the input and output signals. The delay in the output waveform is due to the ionization of the gas which in this case results in a delay of about 10 microseconds. This time delay is a function of the repetition rate. (See Figure 1.3.)

The effect of a change in the load resistance is shown in Figure 3.19 for the leading edge of the waveshape which corresponds to the ionizing condition. The output for the load resistance of 1 megohm indicates an effective inductance in the lamp as well as a longer time lag due to the degree of ionization of the gas. In this case the time lag between the onset of the pulse and the steady state condition is approximately 60 microseconds.

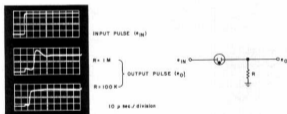

Fig. 3.19. Effect of Changing Load Resistance on Leading Edge of Output Pulse Waveshape.

The distortions in the output waveforms as noted above are not particularly serious problems when the pulse widths of the driving signals are as long as in Figures 3.18 and 3.19 for a frequency of 450 cps. However when the frequency becomes on the order of 5000 cps the distorted part of the waveform will occur over a proportionally larger segment of the waveform and may result in errors or poor operation of the gating circuits. It may become necessary to use lower values of load resistance to minimize this distortion but it is important to remember that lower values of resistance result in larger currents flowing in the lamp and hence a shorter operating life may be expected.

By increasing the value of cathode load resistance the lamp current is reduced. However a value of resistance will eventually be reached where the circuit may break into oscillations. Figure 3.20 shows the result of too large

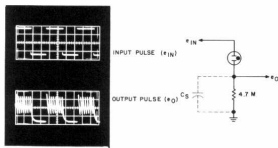

Fig. 3.20. Oscillations Produced in Gating Circuit When Using Large Value of Load Resistance.

a load resistance — in this case 4.7 megohms was sufficient for oscillations to occur in the output signal as shown in the figure. Notice that when considering the stray capacitance across the lamp the gating circuit has the same configuration as the sawtooth oscillator described in Chapter Two. For this reason it is important that the load resistance is not of such a large value that the load line intersects the volt-ampere characteristic of the glow lamp in the negative resistance region. This will normally limit the resistance to a value less than 1 megohm.

COMPUTER AND COUNTING CIRCUITS

In addition to the logic circuits previously described the glow lamp has application in various other circuits which may be used in low-speed computer and counting operations. This section will describe several of these circuits.

Timing Generators

Timing generators produce a series of pulses of a particular frequency and shape. These pulses may be used to time events in a computer and to provide pulses for the logic operations. A series of pulses may also be counted to give an accurate time base for the timing of some other event.

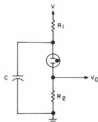

Fig. 3.21. Glow Lamp Pulse Generator.

Figure 3.21 shows one type of pulse generator employing a single glow lamp. The circuit is essentially a sawtooth oscillator with an additional resistor R_2 in series with the glow lamp. As the capacitor charges up the voltage across

the glow lamp increases and when the firing voltage is reached the lamp fires thereby passing a surge of current through the lamp as the capacitor quickly discharges.

The output voltage developed across resistor R_2 is a spike with a relatively fast rise time and a fall time which depends on the deionization properties of the lamp and on the value of capacitor C , resistor R_2 , and the internal resistance of the lamp. The amplitude of the output pulse depends on the product of the current times the resistance R_2 so that the amplitude of the output signal is larger for larger values of resistance. However a point is reached where a further increase in resistance results in essentially no further amplitude increase and operation may become unstable.

The decay time of the output signal is determined approximately by the time constant $C(R_2 + R_b)$ where R_b is the dynamic resistance of the lamp. Therefore in general, at low frequencies where large values of C are required the value of R_2 will be small ($\approx 10K$) whereas at higher frequencies where C is small the values of R_2 may be much larger ($\approx 100K$).

The maximum amplitude of the output signal for a low voltage lamp is normally about 15 volts. Higher amplitudes can be achieved by the use of high voltage lamps such as 4AB or 4AC. The frequency of the timing pulses depends on the capacitor, resistances, supply voltage and lamp parameters as pulse generator operating at a frequency of 5 KC.

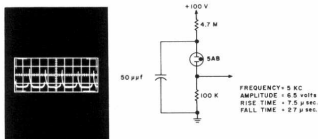

Fig. 3.22. Pulse Generator.

Another commonly used timing generator is the astable (free-running) multivibrator described in Chapter Two. An added advantage of the multivibrator is that it is capable of producing rectangular shaped waves which are often desired in the operation of logic circuits.

Bistable and Monostable Multivibrators

In addition to use as a free-running multivibrator the two-state characteristic of the glow lamp makes it an ideal component for bistable and monostable multivibrator use. Figure 3.23 shows one type of configuration. The ratios of the resistances determine whether the circuit will operate as a bistable multivibrator or as a monostable multivibrator. The circuit is also capable of operating as a free-running multivibrator.

The supply voltage V must be greater than the firing voltage of the lamps but not of such a value that both lamps will conduct simultaneously. Assume that lamp $N1$ is initially conducting. A voltage will then be developed across the

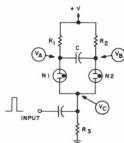

Fig. 3.23. Basic Multivibrator Circuit

common resistor R_3 and the value of this voltage will be such that the voltage across N_2 is insufficient to allow N_2 to fire. The voltage V_A is equal to $V - I_1 R_1$ where I_1 is the current through the conducting lamp N_1 . With N_2 non-conducting $V_B = V$ so that the capacitor is charged to a voltage equal to $I_1 R_1$.

If a positive pulse of sufficient amplitude is now applied to the trigger input across resistor R_3 the conducting lamp N_1 is switched out of conduction as the voltage across N_1 is reduced below the extinguishing voltage of the lamp.

Because of the capacitor C , the voltage at V_A remains low until C can discharge, while the voltage V_B remains equal to the supply voltage V . As the input pulse drops back toward zero the voltage V_C also drops toward zero and as V_C decreases, the voltage across N_2 remains larger than the voltage across N_1 by an amount $R_1 I_1$ and therefore N_2 will fire first. The voltage developed across R_3 will keep N_1 non-conducting and the circuit has now switched states. The next positive pulse will cause the circuit to flip back to the initial state of operation. Thus under these conditions the circuit will act as a flip-flop or bistable multivibrator.

In order to determine the ratios of the resistances for proper operation assume N_1 initially conducting. Then:

$$V_C = \frac{R_3}{R_1 + R_3} (V - V_{M1}) \quad (3.14)$$

where V_{M1} is the maintaining voltage of lamp N_1 . Also:

$$V_A = V_C + V_{M1} \quad (3.15)$$

$$V_B = V \quad (3.16)$$

Then the voltage across N_2 is:

$$V_{N2} = V_B - V_C$$

In order that lamp N_2 is kept in the non-conducting state the breakdown voltage of the lamp V_{F2} must be greater than V_{N2} .

Therefore:

$$V_{F2} > V_B - V_C \quad (3.17)$$

Substituting equations 3.14 and 3.16

$$V_{F2} > V - \frac{R_3}{R_1 + R_3} (V - V_{M1}) \quad (3.18)$$

which reduces to:

$$V_{F_2} > \frac{R_1}{R_1 + R_3} V + \frac{R_3}{R_1 + R_3} V_{M_1} \quad (3.19)$$

or:

$$V_{F_2} > \frac{1}{1 + \frac{R_3}{R_1}} V + \frac{\frac{R_3}{R_1}}{1 + \frac{R_3}{R_1}} V_{M_1} \quad (3.20)$$

Let $X = \frac{R_3}{R_1}$. Then:

$$V_{F_2} > \frac{1}{1 + X} V + \frac{X}{1 + X} V_{M_1} \quad (3.21)$$

Solving for X:

$$X > \frac{V - V_{F_2}}{V_{F_2} - V_{M_1}} \quad (3.22)$$

An identical equation may be obtained for the condition when N2 is conducting and N1 cut-off. Then the values of resistors for the bistable multivibrator are determined from the conditions:

$$\frac{R_3}{R_1} > \frac{V - V_{F_2}}{V_{F_2} - V_{M_1}} \quad (3.23)$$

$$\frac{R_3}{R_2} > \frac{V - V_{F_1}}{V_{F_1} - V_{M_2}} \quad (3.24)$$

Although the lamps do not have to be exactly matched it is recommended that the characteristics of the two lamps do not differ by more than about 5 volts.

Figure 3.24 shows the waveforms obtained with a glow lamp bistable multivibrator. The input pulse is 15 volts at the rate of 5 pulses per second.

Monostable operation may be obtained by a change in the resistance ratios of the basic multivibrator circuit of Figure 3.23. In the monostable operation assume again that N1 is initially conducting and the multivibrator is stable. With an input pulse, N1 will be switched off and N2 switched on with a voltage developed across R_3 due to the current flow through N2. However if the resistance ratio of R_2 and R_3 is of the proper value the voltage across R_3 will not be sufficient to keep N1 from firing as the voltage V_A rises. Thus once the voltage across N1 exceeds the firing voltage it will conduct and the negative pulse coupled through the capacitor C in conjunction with the rising voltage across R_3 will cause N2 to drop out of conduction. The time during which N2 conducts is determined by the capacitor, resistances, supply voltage, and lamp operating voltages.

To determine the design equations for the resistances in the monostable

multivibrator assume that N_1 is the stable lamp. Then the firing voltage of N_1 must satisfy the equation:

$$V_{F_1} < V - I_2 R_3 \quad (3.25)$$

Then following the same procedure as with the bistable multivibrator the following design conditions are obtained.

For N_1 stable:

$$\frac{R_3}{R_1} > \frac{V - V_{F_2}}{V_{F_2} - V_{M_1}} \quad (3.26)$$

$$\frac{R_3}{R_2} < \frac{V - V_{F_1}}{V_{F_1} - V_{M_2}} \quad (3.27)$$

where V_F and V_M are the firing and maintaining voltages respectively.

Figure 3.25 shows a typical monostable multivibrator and the output wave-shapes. The input pulses are +15 volts at a rate of 1.5 pulses per second.

Both the bistable and monostable circuits of Figures 3.24 and 3.25 require input trigger pulses of at least 5 volts peak. The rate at which the multivibrators will operate properly depends on the charging and discharging times of the capacitor and on the ionization and deionization times of the glow lamps.

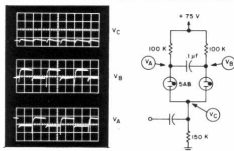

Fig. 3.24. Typical Bistable Multivibrator Operation.

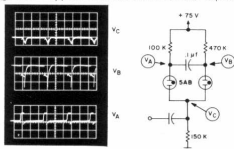

Fig. 3.25. Typical Monostable Multivibrator Operation.

The basic multivibrator circuit of Figure 3.23 will become free-running if an insufficient voltage is developed across resistor R_3 . Then for free-running operation:

$$\frac{R_3}{R_1} < \frac{V - V_{F_2}}{V_{F_2} - V_{M_1}} \quad (3.28)$$

$$\frac{R_3}{R_2} < \frac{V - V_{F_1}}{V_{F_1} - V_{M_2}} \quad (3.29)$$

A Glow Lamp Ring Counter

A glow lamp ring counter capable of counting at rates up to several hundred pulses per second was first reported by Manley and Buckley¹. A modified version of this ring counter is shown in Figure 3.26 for a count-of-six counter. Any even number may be counted by adding additional pairs of glow lamp-semiconductor diode combinations.

The input to the counter consists of positive pulses of at least 30 volts peak. All lamps in the circuit are high-voltage 4AC lamps. Lamps should

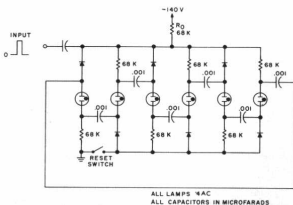

Fig. 3.26. Glow Lamp Ring Counter

¹"Neon Diode Ring Counter", J. C. Manley and E. F. Buckley, Electronics, January 1950, pp 84-87.

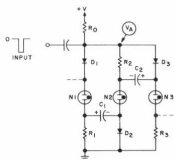

Fig. 3.27. Ring Counter.

be aged for best results and some selection may be desirable. The operation of the ring counter will be described by referring to Figure 3.27.

Assume that lamp N_1 is initially conducting. The resistances R_0 and R_1 are chosen such that voltage V_A is insufficient to cause any of the other lamps to fire. With N_1 conducting, a voltage is developed across R_1 so that capacitor C_1 charges through diode D_2 to approximately the voltage across resistor R_1 .

If an input negative pulse is now applied, the voltage at V_A will drop below the extinguishing voltage of N_1 and thus N_1 will stop conducting. Capacitor C_1 will now start to discharge through R_1 and the high back resistance of diode D_2 . Since the back resistance of diode D_2 is much larger than the resistance of R_1 essentially the full voltage developed across C_1 will now appear across diode D_2 with the result that the cathode of N_2 now has a large negative potential.

When the input trigger pulse returns to zero the voltage at V_A rises and with the added negative potential on the cathode, lamp N_2 will fire first and the other lamps will remain non-conducting.

Capacitor C_2 will now charge to approximately the voltage drop across resistor R_2 . A second input pulse will extinguish lamp N_2 with the voltage developed across C_2 now appearing across diode D_3 as C_2 attempts to discharge. When the input pulse again rises to zero V_A rises and with the added voltage across diode D_3 lamp N_3 will now fire first.

Thus each successive input pulse has resulted in a counting process with the glow lamps being fired in sequence. An output signal may be taken from the lamp-resistor-capacitor common connection. This pulse is essentially rectangular and for the circuit of Figure 3.26 the amplitude of this output pulse was about 40 volts.

Memory Circuits

The properties of the glow lamp make it a very suitable device for several different types of storage or memory circuits. One such memory circuit is shown in Figure 3.28.

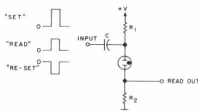

Fig. 3.28. Glow Lamp Memory Circuit.

The supply voltage V is between the breakdown and the maintaining voltages of the lamp so that in the quiescent condition the lamp is non-conducting.

If a positive "set" pulse is now applied to the input the lamp will fire and with the supply voltage greater than the maintaining voltage, the lamp will remain conducting. The amplitude of the set pulse must be large enough to fire the lamp and thus must be greater than the difference between the firing voltage of the lamp and the supply voltage.

Therefore:

$$V_{\text{set}} > V_F - V \quad (3.30)$$

where:

$$V_M < V < V_F \quad (3.31)$$

To read out of the memory circuit a positive "read" pulse is applied to the input. The amplitude of the "read" pulse must be less than that required to fire the lamp if the lamp is non-conducting. Thus:

$$V_{\text{read}} < V_F - V \quad (3.32)$$

If the lamp has been previously fired by a "set" pulse the "read" pulse will be passed through the lamp to the output, however, if the lamp has not been fired the "read" pulse will be blocked by the non-conducting lamp and the lamp and the output will remain at zero.

To reset the memory circuit a negative "reset" pulse is applied to the input. The magnitude of this pulse must be sufficient to drop the voltage across the lamp below the extinguishing voltage. Thus:

$$|V_{\text{reset}}| > V - V_E \quad (3.33)$$

Another type of memory circuit which is becoming quite popular employs a glow lamp in conjunction with a photoconductor or other type of photosensitive device. The photoconductor has a decreasing resistance as the incident illumination is increased. Figure 3.29 shows one manner in which a glow lamp and photoconductor may be used as a memory circuit.

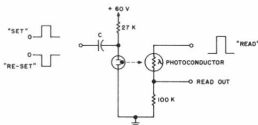

Fig. 3.29. Glow Lamp - Photoconductor Memory Circuit.

With the glow lamp non-conducting the resistance of the photoconductor is very large and any input "read" pulse will be attenuated by the photoconductor by a factor greater than 100 to 1. However if the glow lamp is triggered on, the light from the glow lamp will cause the resistance of the photoconductor to decrease to a low value depending upon the characteristic of the photoconductor and the light output of the lamp. The "read" pulse will now appear at the output attenuated only by the low resistance of the illuminated photoconductor.

Additional information on the operation of glow lamp-photoconductor combinations is given in Chapter Four.

REFERENCE LIST

- "Neon Diode Ring Counter", J.C. Manley and E.F. Buckley, *Electronics*, January 1950, pp 84-87.
- "Neon Lamp Flip-Flop and Binary Counter", H.A. Vuylsteke, *Electronics*, vol 26, April 1953, p 248.
- "Transient Response of Glow Discharges with Applications", R.S. Mackay and H.D. Morris, *Proceedings of the I.R.E.*, vol 42, June 1954, pp 961-964.
- "Digital Storage Using Neon Tubes", M.S. Raphael and A.S. Robinson, *Electronics*, vol 29, July 1956, pp 162-165.
- "A Study of the Neon Bulb as a Non Linear Circuit Element", C.E. Hendrix, *IRE, Transactions on Component Parts*, September 1956, pp 44-54.
- "Pulse and Digital Circuits", J. Millman and H. Taub, McGraw-Hill Book Company, 1956, Chapter 13.
- "Demonstration Neon Multivibrator", L.W. Orr, *Electronics*, June 1, 1957.
- "Neon Triode Gives Low-Speed Gate", R.L. Ives, *Electronics (Engineering Issue)*, March 14, 1958, pp 170-176.
- "Neon Lamp Logic Gates Play Tick-Tack-Toe", C.E. Hendrix and R.B. Purcell, *Electronics (Engineering Issue)*, June 20, 1958, pp 68-69.
- "Neon Oscillator Rings", R.L. Ives, *Electronics (Engineering Issue)*, October 10, 1958, pp 108-115.
- "Mathematics and Logic for Digital Devices", J.T. Culbertson, D. Van Nostrand Company, Inc., Princeton, New Jersey, 1958.
- "Switching Circuits", W.S. Humphrey, McGraw-Hill Book Company, New York, 1958.
- "Introduction to Symbolic Logic and Its Applications", R. Carnap, Dover Publications, New York, 1958.

"Switching Circuits and Logical Design", S.H. Caldwell, John Wiley and Sons, New York, 1958.

"Logical Design of Digital Computers", M. Phister, John Wiley and Sons, New York, 1958.

"Digital Computer Primer", E.M. McCormick, McGraw-Hill Book Company, New York, 1959.

"Computers and the Neon Lamp", J.H. Thomas, Radio-Electronics, November 1959.

"Photoconductive Matrix Simplifies Counter Display", R.H. Harrison, Electronics, December 22, 1961, pp 28-30.

"Neon Lamps for Low-Speed, Low-Duty-Cycle Logic", P. Laakman, Electronic Design, June 7, 1962, p 56

In addition to the applications of glow lamps discussed in the previous chapters there are a great number of other applications for this versatile device. This chapter will discuss four major applications. A reference list following the end of the chapter gives a partial list of the many additional glow lamp applications found in the literature.

VOLTAGE REGULATORS

The maintaining voltage of a conducting glow lamp is fairly constant over a relatively wide current range. This characteristic of the glow lamp makes it an ideal component for low cost voltage regulation in circuits where the currents involved do not exceed the normal constant voltage range of the lamp. In general the voltage to be regulated must be the total maintaining voltage of one or a number of glow lamps in series. For best results pre-aged lamps should be used in the following applications.

The most common application for the glow lamp as a voltage regulator is in providing the screen voltage for pentode vacuum tubes. A typical circuit for this application is shown in Figure 4.1.

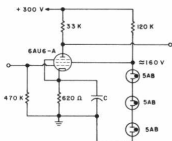

Fig. 4.1. Pentode Amplifier Employing Glow Lamps for Screen Grid Voltage Regulation.

The current drawn by the glow lamp must remain within the operating current range of the lamp over the range of screen grid current drawn by the vacuum tube. In addition, the current drawn by the lamp must be large enough that the lamp will not produce oscillations. Figure 4.2 shows a typical volt-ampere curve covering the normal region of voltage regulation. The curve is for an 5AB lamp.

When a glow lamp is used as a voltage regulator the voltage will vary slightly as a function of temperature. Figure 4.3 shows a typical curve of lamp voltage versus temperature for an 5AB lamp operating at the rated lamp current of

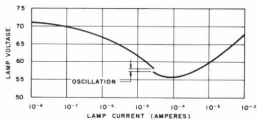

Fig. 4.2. Volt-Ampere Characteristic Curve for Aged 5AB Glow Lamp.

.3 milliamperes. The maintaining voltage of the 5AB and related low voltage types has a decreasing temperature characteristic of about 40 millivolts per degree Centigrade when operating at the rated current of the lamp.

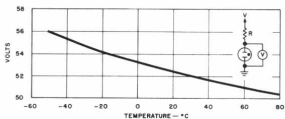

Fig. 4.3. Typical Temperature Response of Glow Lamp Voltage Regulator.

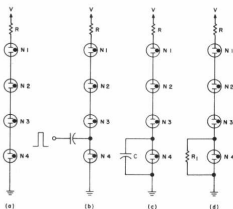

Fig. 4.4. Starting Methods for Glow Lamp Regulators.

By placing a large number of glow lamps in series, high regulated voltages may be obtained. The total voltage is then equal to the sum of the maintaining voltages of the lamps.

In order to fire the lamps in a series string several methods may be used. If the supply voltage is in excess of the total firing voltages of the lamps then the lamps will fire when the voltage is applied. This situation is shown in Figure 4.4a.

For this case then:

$$V > V_{F1} + V_{F2} + V_{F3} + V_{F4} \quad (4.1)$$

By using a triggering pulse to fire the lamps a lower supply voltage is required. An application showing this method is shown in Figure 4.4b. The amplitude of the triggering pulse must be large enough to fire the lower lamp. Once this lamp is fired the voltage across it drops to the maintaining voltage of the lamp and thus places a higher voltage across the other three lamps.

Then in order that the other three lamps will fire:

$$V > V_{F1} + V_{F2} + V_{F3} + V_{M4} \quad (4.2)$$

A third method for initiating conduction in the lamps is shown in Figure 4.4c. When the supply voltage is applied to the network, capacitor C acts as a short circuit so that the total voltage is placed across lamps N1, N2, and N3. The supply voltage must be large enough to cause these three lamps to fire.

Therefore:

$$V > V_{F1} + V_{F2} + V_{F3} \quad (4.3)$$

After the lamps have fired, the capacitor begins to charge up through the conducting lamps with the voltage across N4 rising. When this voltage reaches the firing voltage of N4 it will fire. This places an additional requirement on the supply voltage.

$$V > V_{M1} + V_{M2} + V_{M3} + V_{F4} \quad (4.4)$$

Another method of starting a series string of glow lamps is the use of a high (10 megohms) resistance bridging one or more of the lamps. This is shown in Figure 4.4d. The voltage across each lamp is determined by the capacity as well as the "off" or leakage resistance of each lamp in the string.

This bridging resistance reduces the net resistance of the bridged lamps leaving a larger portion of the applied voltage for the rest of the lamps in the string. If proper values are used, there will be sufficient voltage to break down these lamps. The voltage drop across these lamps will then be the sum of their maintaining voltages, and the difference between this and the supplied voltage must now be large enough to break down the bridged lamp or lamps.

Larger strings of series lamps may be used for high voltage regulation with firing of the lamps initiated by applications of these firing techniques.

Preaged lamps such as the 3AG-A, 3AG-B, 3AG-C, 5ABA, 5AB-B, 5AB-C, 5AC, 5AG or 5AG-A work well in voltage regulation circuits. For higher current applications, use of one of the 5AH or 5AJ family should be considered.

VOLTAGE LEVEL DETECTORS

The glow lamp has a very high input resistance prior to firing and after firing gives a visual indication that the lamp is conducting. Both of these characteristics make the glow lamp suitable to various applications as voltage level detectors. Practically any number of glow lamps may be placed in a series string so that very high voltages may be detected. The current required to give a visual indication is very low so that even after the lamps have fired, the detector circuit may have a negligible loading effect.

In general the voltage required to fire a glow lamp voltage detector will be the sum of the firing voltages of the lamps in the series string, assuming leakage resistances are similar. If higher resolution is required a variable bias voltage may be provided such as shown in Figure 4.5. By switching lamps in or out of the circuit a wide range of voltages may be detected.

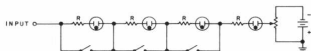

Fig. 4.5. Variable Voltage Level Detector.

Another type of circuit which acts as a variable voltage detector is shown in Figure 4.6a. By varying the potentiometer the circuit may be adjusted to indicate any voltage greater than the firing voltage of the lamp. A variation of this circuit shown in Figure 4.6b will detect two voltage levels. N1 will fire when its firing voltage is reached and N2 will fire at a voltage dependant upon the input voltage and the ratios of R_1 and R_2 .

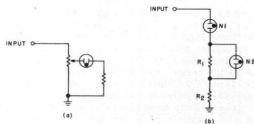

Fig. 4.6. Voltage Level Detectors.

These voltage indicating circuits may be used equally well for both DC voltages and peak AC voltages at low frequencies.

Several references at the end of the chapter give specific applications of the glow lamp voltage level detector.

COUPLING NETWORKS

The neon glow lamp can be operated in a condition where the DC resistance is much larger than the AC impedance of the lamp. This is achieved by superimposing an AC signal across a lamp conducting direct current. The DC bias provides a relatively fixed voltage drop across the lamp. Under this condition a DC component of an input signal will be attenuated much more than the AC component. This property of the glow lamp makes it an ideal device for lowering the DC level in direct coupling of vacuum tube stages.

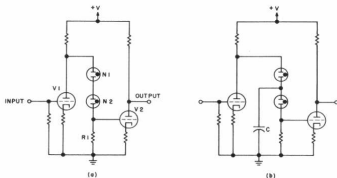

Fig. 4.7. Direct Coupled Circuits Employing Glow Lamps.

Figure 4.7a shows the basic configuration for direct coupling with glow lamps. The plate voltage of V_1 must be such that the lamps will fire. In selecting resistor R_1 several considerations must be made. The value of R_1 in conjunction with the plate voltage and equivalent resistance will determine the value of DC current in the lamp and thus the value of the AC impedance of the lamp. In addition the larger the value of R_1 the greater will be the proportion of the AC plate voltage of V_1 seen at the grid of V_2 . However as R_1 becomes larger the DC voltage component on the grid of V_2 also becomes larger, thus requiring a larger cathode resistor for V_2 and consequently more degeneration of the AC signal. The circuit components chosen will normally be a compromise and the largest AC gain of the amplifier is best found by a trial-and-error approach.

The plate voltage of V_1 may be operated slightly less than the combined firing voltage of lamps N_1 and N_2 when a capacitor is added as shown in Figure 4.7b. This capacitor serves the same purpose as for the voltage regulator circuit of Figure 4.4c and the same design conditions apply. The value of the capacitor may be on the order of only 25 pf so that it will offer a high impedance to the AC signal.

The impedance presented by the glow lamps in a direct coupled circuit varies as a function of the DC current and the frequency of the input signal. At frequencies below about 1000 cps the impedance of the lamp is essentially resistive with the magnitude of the resistance depending upon the slope of the volt-ampere characteristic of the lamp at the particular operating point.

As the frequency becomes higher the lamp becomes inductive so that for frequencies higher than about 1000 cps the lamp may be represented by an AC equivalent circuit of a resistance in series with an inductance. Both the value of the resistance and the inductive reactance increase with increasing frequency. In addition the impedance varies with the DC lamp current. Figure 4.8 is a plot of the effective resistance and reactance of an 5AB glow lamp operating at the rated current of .3 milliamp. The input AC signal was 1 volt RMS.

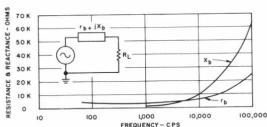

Fig. 4.8. Effective Resistance and Reactance of 5AB Glow Lamp Operating in a Coupling Circuit at 0.3 Milliampere DC.

The effect of this lamp impedance is to introduce an attenuation and a phase shift in the signal as the frequency of the signal is increased. To reduce this effect and hence increase the high frequency response of a glow lamp coupled amplifier a capacitor may be placed across the glow lamps. A typical circuit is shown in Figure 4.9 with the response curves shown in Figure 4.10 for both conditions - with and without a bypass capacitor. The low frequency voltage gain of the circuit is 48.

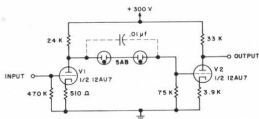

Fig. 4.9. Glow Lamp Coupled Amplifier.

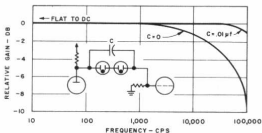

Fig. 4.10. Amplitude Response of Glow Lamp Coupled Amplifier.

Any number of glow lamps may be used in a direct coupled stage provided that the applied DC voltage is sufficient to fire the lamps. The magnitude of the maximum AC signal depends on the degree of distortion permissible. Normally signal amplitudes of several volts will have little distortion.

THE GLOW LAMP AND PHOTOCONDUCTIVE DEVICES

An increasing number of applications are being found for the glow lamp in conjunction with photoconductive devices. Among these photoconductive devices are the cadmium sulfide and cadmium selenide photoconductors and photosensitive semiconductor devices. The spectral response and light intensity of many of these devices is compatible with the light output of the neon glow lamp. In addition the low power consumption and speed of response of the glow lamp makes it a desirable light source. Either standard brightness or high brightness glow lamps may be used with photoconductive devices.

Photoconductive Cells

A photoconductive cell, or photocell, is a device whose resistance varies with the amount of light radiation impinging upon its surface. Although many types of photoconductive materials are in use, or under development, cadmium sulfide and cadmium selenide are presently the most widely used. Each offer certain advantages over the other.

The spectral response of the cadmium sulfide photocell normally peaks around 5500 Angstroms while the cadmium selenide photocell peaks around 7000 Angstroms. Thus the cadmium selenide photocell is normally better matched to the neon glow lamp spectral emissivity. However, variations in the mix, materials, and processing of a photoconductive cell will allow its peak spectral sensitivity to be varied over a wide range.

Photocells vary considerably in terms of light-to-dark resistance ratios and in their value of resistance at a given light level. A typical cadmium sulfide cell may have a light-to-dark resistance ratio of 1,000,000 or more. The resistance of a photocell is normally specified at one or more levels of illumination. The resistance of a photocell is a very nearly logarithmically linear as a function of the illumination. The resistance decreases with increasing illumination.

Sensitivity of photoconductors varies with temperature; cadmium sulfide, however, is much more temperature-stable than cadmium selenide. In fact, the major disadvantage of cadmium selenide cells is their susceptibility to temperature variations.

Photocells have two response speeds; turn-on response and turn-off response. In general the response speed of cadmium sulfide cells will average 100 milliseconds. The response speed of cadmium selenide cells is approximately 10 milliseconds. Response speeds of both types are dependent on the previous state of the device and the illumination level. Hence in photocell-glow lamp combinations the speed of response will normally be limited by the photocell.

Several glow lamp-photocell circuits have been given in previous sections of this book. In addition other applications are described in the references listed at the end of the chapter. The most common use of the glow lamp-photocell combination has been in memory and logic circuits. In these applications the input circuit is isolated from the output circuit — an advantage not obtained by most memory devices. In addition a single photocell output circuit may be actuated by a number of glow lamp sources or one lamp may actuate several photocells.

The glow lamp-photoconductor combination is best used where the resistance of the photocell is switched from a very high resistance to a low resistance depending upon whether the glow lamp is conducting or not. In addition the resistance of the photocell may be varied by varying the light output or position of the glow lamp. This provides a control where there is electrical isolation between the control circuit and the receiving circuit.

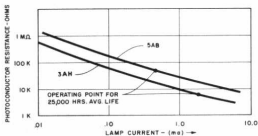

Fig. 4. 11. G. E. B-425 Photoconductor Resistance vs Lamp Current — 5AB and 3AH (Lamp Located 1.5" From Cell)

Figure 4.11 is a typical plot of photocell resistance as a function of lamp current in the 5AB standard brightness and the 3AH high brightness glow lamps. The lamp is located about 1.5 inches from the photocell in a dark enclosure. The dark resistance of this photocell was in excess of 10 megohms, and other types are available with even higher resistance.

MISCELLANEOUS APPLICATIONS

A variation of the light indicator described in Chapter Two is a circuit consisting of a photoconductor in parallel with a glow lamp. At a specific light level the lamp will fire, providing visual indication.

This same principle can be used in the design of a temperature indicator, which utilizes a thermistor in parallel with a glow lamp. Here a visual indication

is provided at a specified temperature by the firing of the glow lamp, or a photoconductor can be used to sense the firing and actuate external circuitry.

Likewise, a humidity sensing circuit can utilize a humistor as a variable resistance in parallel with the glow lamp. Humistor resistances typically decrease with an increase in humidity. Once again, the firing of the glow lamp at a specific humidity can be used for visual indication or to actuate external circuits.

Since consistent firing voltage is required for the above applications the use of a preaged lamp such as the 5AG-A is recommended.

REFERENCE LIST

- "The Application of the Gaseous Discharge Tube to Problems of Voltage Regulation", *Journal of Scientific Instruments*, vol 14, May 1937, pp 161-164.
- "Relaxation Circuit Measures Radiant Energy", A. Stager, *Electronics*, vol 10, July 1937, p 29.
- "Gas-Tube Coupling for D-C Amplifiers", F. Iannone and H. Baller, *Electronics*, vol 19, October 1946, pp 106-107.
- "Novel Application for Neon Diodes", I. Gottlieb, *Electronics*, January 1951, pp 180-186.
- "Direct Coupled Control Circuit not Requiring Cascaded Power Supplies or Special Biasing Voltages", J. Degelman, *Review of Scientific Instruments*, vol 22, November 1951, p 847.
- "R-F Bursts Actuate Gas Tube Switch", H.J. Geisler, *Electronics*, February 1952, pp 104-105.
- "Neon Lamps as Circuit Elements", W.R. Kincheloe, Jr., Technical Report No. 10, Stanford University Electronics Research Laboratory, May 26, 1952.
- "Neon Indicator Tubes as Quantitative Detectors in Photometry", *British Journal of Applied Physics*, vol 4, August 1953, pp 245-247.
- "Cold Cathode Tubes for Transmission of Audio Frequency Signals", *Bell System Technical Journal*, vol 32, November 1953, pp 1371-1391.
- "Relaxation Oscillations in Voltage-Regulator Tubes", P.L. Edwards, *Proc. I.R.E.*, vol 41, December 1953, pp 1756-1760.
- "Transient Response of Glow Discharges with Applications", R.S. Mackay and H.D. Morris, *Proceedings of the I.R.E.*, vol 42, June 1954, pp 961-964.
- "Electrically Variable Gas-Dielectric Capacitor", J.F. Gordon, *Electronics*, January 1956, pp 158-160.
- "Alarm System Uses Gated Neon Warbler", R.L. Ives, *Electronics (Engineering Issue)*, May 23, 1958, pp 74-77.
- "Electronic Level Indicators for Tape Recorders", H. Burstein, *Radio and TV News*, December 1958, p 42.
- "Kill Commercials Fast", O. Relling, *Radio-Electronics*, June 1959, pp 32-33.
- "9 Uses for the 9 Cent Wonder", R.B. Kuehn, *CQ*, August 1959, p 49.
- "Oscillator Control Circuit Uses Neon Bulb", J. Tewksbury, *Electronics*, January 26, 1962, p 52.
- "Neon Tube Serves as Tuning Indicator for F.M. Receiver", M.W. Edgerton, Jr., *Electronic Design*, March 15, 1962.
- "Neon Lamp Leakage Tester", J.A. Hastings, *Electronics World*, May 1962, p 74.
- "Neon Lamps Make a Voltage Indicator", L.E. Greenlee, *Radio-Electronics*, September 1962, pp 98-99.
- "Neon Lamps Provide Simple Voltage and Frequency Indication", J. DeMatteo, M. Weiner, R. Grant, *Electrical Design News*, September 1962, p 41.

TEST CIRCUITS

The glow lamp is a very high resistance device when in the non-conducting state and as such requires special care when attempts are made to measure its parameters. The lamp characteristics of value to the circuit designer are the firing voltage, the maintaining voltage and the extinguishing voltage. The values of these parameters change as a function of frequency and associated circuit components so that the type and accuracy of the measurement depends upon the requirement. For normal circuit component use the tests are usually made easily and quickly.

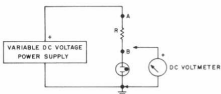

Fig. 5.1. Test Circuit for Determining Lamp DC Voltage Characteristics.

Figure 5.1 shows a test setup which may be used for making approximate measurements of the lamp parameters. A voltmeter with a resistance of 20,000 ohms per volt is sufficient to prevent loading of the lamp circuit.

With the voltage initially at a value below the expected firing voltage of the lamp the voltmeter lead is placed at point A. The supply voltage is then slowly raised until the lamp just fires which is indicated visually by the cathode glow. The reading of the voltmeter will now give the value of the firing voltage of the lamp under test. The DC voltmeter probe may now be moved to point B and the maintaining voltage will be indicated. If it is desired to know the maintaining voltage at a particular value of current the supply voltage may be varied until the proper current is obtained — assuming that the resistance is such as to permit the desired amount of current to flow. The approximate value of current may be obtained by measuring the voltages at points A and B. The current is then

determined by the equation $I = \frac{V_A - V_B}{R}$.

After the maintaining voltage is measured the voltmeter probe may be returned to point A. The voltage is then slowly decreased until the lamp current abruptly ceases. The voltage at this point is the extinguishing voltage for the given value of resistance R.

Care must be taken in choosing the value of resistance R in the measuring circuit since large values of R in conjunction with stray capacitance may cause the circuit to oscillate once the lamp has fired.

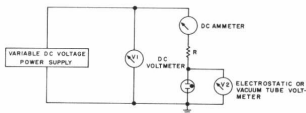

Fig. 5.2. Test Circuit for Determining Lamp DC Voltage Characteristics.

Another testing circuit is shown in Figure 5.2. Two voltmeters may be used to avoid changing leads. Voltmeter V_2 which is placed across the glow lamp should be of the electrostatic or vacuum-tube type of voltmeter with an input resistance greater than ten megohms. If an electrostatic voltmeter is used a resistance of about 10 to 30 megohms should be placed in series with the meter to suppress a tendency of the circuit to oscillate due to the meter's capacity. Voltmeter V_1 need not have a very high input resistance as its shunting effect on the test circuit is negligible.

The firing voltage is determined by slowly raising the supply voltage and noting the value of voltage measured on voltmeter V_1 when the lamp just begins to glow or the ammeter gives an indication of conduction through the lamp. Current should normally be close to the lamp's rated value. The internal resistance of this ammeter should be less than one percent of the value of R .

With the lamp operating at the desired current as indicated by the ammeter the maintaining voltage may be read by voltmeter V_2 . To measure the extinguishing voltage the supply voltage is decreased slowly and the voltage is read on voltmeter V_1 when the lamp ceases conduction.

It is often desirable to measure the dynamic values of firing and extinguishing voltage for a circuit in operation; for example, a sawtooth oscillator. Figure 5.3 shows a circuit which may be used to effectively isolate the glow lamp circuit from the test circuit. The vacuum tube cathode follower stage has essentially an infinite resistance at the grid input so that there is negligible loading on the lamp circuit. In addition the input capacitance of the cathode follower is very low so that the total capacitance shunting the glow lamp is on the order of only a few micro-micro-farads.

The transfer characteristic of the cathode follower may be determined by varying a DC voltage on the grid and measuring the corresponding output cathode voltage. An alternate method of obtaining the approximate transfer function of the cathode follower is to drive the grid with a small sine wave signal superimposed on a DC bias of perhaps 50 volts as shown in Figure 5.4. The DC transfer characteristic of the cathode follower is then approximately:

$$v_o = Av_i + E_{ko} \quad (5.1)$$

where A is the small signal AC gain (less than unity) and E_{ko} is the DC cathode voltage measured with the grid grounded.

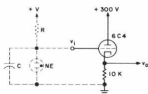

Fig. 5.3. Test Circuit for Determining Dynamic Lamp Characteristics with Lamp Circuit Isolated from Output.

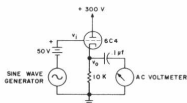

Fig. 5.4. Test Circuit for Determining Approximate Transfer Function of Cathode Follower.

After the transfer function of the cathode follower has been determined the dynamic firing and extinguishing voltages of the glow lamp circuit may be measured by using a calibrated DC oscilloscope on the output.

The cathode follower circuit also provides another means of measuring the DC firing and maintaining voltages of a glow lamp. If an oscilloscope is used which has an output sawtooth sweep available at a very low frequency and a voltage greater than 100 volts this slowly rising voltage may be used as a variable supply voltage for a glow lamp with a series resistor as shown in Figure 5.5. By placing the output of the cathode follower to the vertical input of the DC oscilloscope voltages proportional to breakdown potential and the maintaining voltage of the lamp may be measured from the scope presentation. The actual values of the breakdown voltage and the maintaining voltage may then be determined by using the equation for the transfer function of the cathode follower.

This method of determining the operating characteristics of lamps is particularly useful when large numbers of lamps are to be measured.

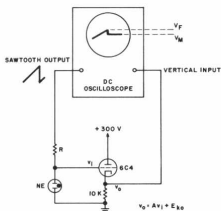

Fig. 5.5. Alternate Method of Determining Firing and Maintaining Voltages of Neon Glow Lamps.

CONDITIONS FOR LAMP MEASUREMENTS

In determining the parameters of a glow lamp care should be taken to provide the proper environment. Recommended practices are:*

1. Lamp measurements should be made at room temperature of about 25°C.
2. For measurements to be made in light the measurement should be made in an unobstructed ambient illumination of 5 to 50 footcandles. The lamp which is to be tested should be operated in the conducting state for a short period prior to measurement.
3. In the case where it is desired to measure a lamp in total darkness the lamp should be inoperative for a period of at least 24 hours immediately prior to testing and the enclosure should be light-tight.
4. Under conditions of life testing of glow lamps the lamps should be operated at the specified design current while also observing the correct polarity of the lamp when indicated.
5. Life testing of glow lamps should be interrupted once a day.

Specific applications may require testing procedures which deviate from recommended practices.

In placing a lamp in a testing circuit care should be taken to avoid the capacitive effect of having other objects in contact with the lamp. These objects, such as metal plates and shields, should be kept at least six inches away from the lamp to be tested. In addition, touching the lamp during testing should be avoided as errors will probably result. Proper shielding may be required to minimize the effects of stray fields and radio-frequency radiation which have a decided effect upon the firing voltage of the lamp.

*"Measurement of Glow Lamps", A.S.A., 10 East 40th Street, New York 16, New York.

MEASURING THE DELAY TIMES OF GLOW LAMPS

When a designer considers the use of glow lamps for bistable logic elements, he must know how fast these devices respond to pulses. He must know this for given types of neons and for the operating environment.

Since there are quite a few types of neon devices, and many different operating environments, the engineer will probably want to make his own tests. In this manner he will be able to compare one neon device to another, learn the statistical spread for a given neon type and determine the effect of his operating environment.

A neon's response to a positive-going turnon pulse (Fig. 5.6) breaks down into two factors, which should be measured separately: speed of response and voltage level at which the neon is retriggered. The test setup in Fig. 5.7 measures the former and that in Fig. 5.10 measures the latter.

Both parameters are a function of the excitation within the neon gas. Therefore the tests for these parameters must include the major environmental and circuit effects that influence this level of excitation.

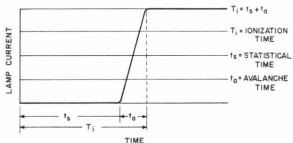

Fig. 5.6. Delay times for neon turn-on defined.

In the first test (Fig. 5.7), the ionization time, the time that it takes a neon to respond to a positive-going pulse is the sum of the statistical time (t_s) required for the first free electron to form in the gas and the avalanche time (t_a) needed for the first free electron to create the full flow of electrons.

The statistical time is a function of the general state of excitation in the electrons at the time the pulse is received. This, in turn, is a function of excitation remembered from recent ON states and environmental factors, such as the ambient light level, electric field strength, cosmic rays and, of course, the circuit-imposed potential on the electrodes. It is, also a function of various construction properties, such as gas composition and isotope content, but these

*"Measuring the Delay Times of Glow Lamps", C. R. Dougherty, and R. D. Smith, Electronic Design March 30, 1964.

are outside the control of the circuit designer once he chooses a particular neon type.

Avalanche time (t_{av}), on the other hand, depends mainly on just the circuit-imposed electrode potential.

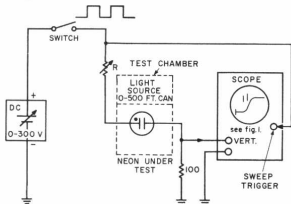

Fig. 5.7. Setup for measuring a neon's ionization time.

The following steps are needed to set up the ionization time test shown in Figure 5.7:

1. Place the neon inside a chamber, which isolates it from all environmental effects. The chamber should have provisions for the controlled introduction of environmental effects. An aluminum box measuring 12 x 12 x 14 in. high can be used with the inside walls blackened. A cool white fluorescent light panel, measuring 12 x 12 in., can be set in the top with a clear conductor attached to the aluminum chamber. The conductor will screen the neon from the stray electrical fields produced by the fluorescent panel. The aluminum chamber shields the neon from electric fields and the fluorescent light provides the ambient light for the tests.

A variable impedance can be used to vary the fluorescent's intensity from 0 to 500 foot candles. A photo-electric cell located near the neon under test, wired to an external meter, measures the amount of light. The spectrum of the light source should correspond to that of the intended application. The cool white fluorescent was felt to be a good compromise between daylight and incandescent conditions.

2. Provide a dc power source that can be varied between 0-300 v. Since neons draw only 0.1 to 1 ma currents and have high impedances, this can be merely a string of 90-v cells bridged by a potentiometer.
3. Arrange the switch to connect the power source to the test circuit so the neon has an OFF time of at least 8 sec. This is necessary to allow the excitation within the gas to decay sufficiently from the ON state level so that "remembered" ionization will no upset the accuracy of this test. (The second test, Fig. 5.10, will include this effect.)

Actually, even longer OFF times may be needed if zero foot-candle light-condition tests are to be run. A switching rate of slightly less than 6

cycles/min. will be adequate in most cases. This will have 8 sec OFF times and 3 sec ON times. A further requirement for this switch is that it should have transients of less than $0.5 \mu\text{sec}$.

The working part of an ordinary household mercury wall switch can handle this function. The barrel portion can be removed from the wall switch, mounted on the pivot bearings from the switch and rotated by a small synchronous motor. This device has a clean switching waveform and is able to handle the voltage levels used with neons.

4. Use an oscilloscope with a vertical sensitivity of 0.05 v/cm . It should have an externally triggerable horizontal time base, sweeping at 1 msec/cm . An interval counter could be used to help time the delay.

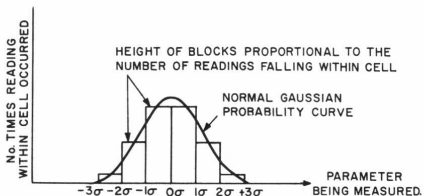

Fig. 5.8. Arrangement of the data in histogram form.

At the start of each test, resistance R should be adjusted to operate the lamp at 105 per cent breakdown voltage. Then at least five consecutive readings should be made for each lamp with 105, 110, 120, 140 and 180 per cent over voltage. It is important that enough readings be taken for the data to be treated in a statistical manner. That is, it should be possible to arrange the readings in a histogram, as in Fig. 5.8, so that an approximately Gaussian curve can be drawn through the results and statistically meaningful worst-case values can be selected for the final results.

Fig. 5.9 shows a typical family of curves that would be produced. The ionization time is plotted against the per cent breakdown voltage. Each curve represents a certain ambient light level. Note that the response is faster for higher voltages, but that it is even more sensitive to light levels. The largest change is between no light at all (zero foot candles) and a small amount of light (0.1 foot candles). For reference, ambient light levels range from 30 to 60 foot candles in office areas and up to 100 foot candles in well-lighted laboratories.

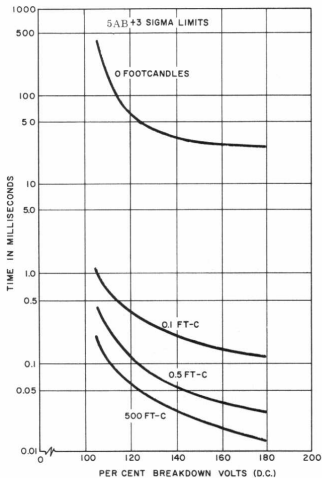

Fig. 5.9. Ionization time vs percentage of dc breakdown voltage.

The curves in Fig. 5.9 are for the 3 sigma limit, or worst-case values that include 99.8 per cent of the neon devices. They are for 5AB neons.

REFIRING Voltage Plotted As a Function of Time Off

In single-shot circuits, the ionization or turn-on time of the glow lamp may be the only frequency-limiting factor. Generally, in repetitive signal circuits it will be necessary to also know the deionization time. This turn off parameter can be measured directly but the procedure is quite complicated. An easier parameter to measure is the refiring voltage as a function of time off. The setup for this measurement is shown in Fig. 5.10.

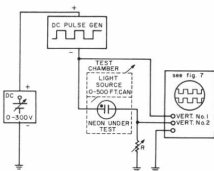

Fig. 5.10. Test setup for measuring refring voltage
As A Function Of Time Off.

The test chamber and dc power supply for this test are identical to those in Fig. 5.7. But the oscilloscope should be a dual-beam type with vertical sensitivity of 0.5 v/cm and a horizontal sweep of 1 sec/cm. Two oscilloscopes could be used with a common timing reference.

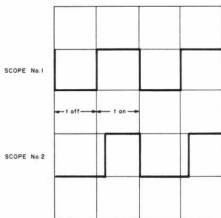

Fig. 5.11. Appearance of dual-trace scope display obtained
from Fig. 5 test setup.

In addition, a variable pulse width dc pulse generator should be available. Ideally, it should have enough output amplitude to completely cancel the dc power supply. (The authors made do with a generator limited to 60 v maximum pulse amplitude, though this did not completely attain the zero volt OFF states.)

As an added aid to accurately determining the voltage levels, a high impedance VTVM or electrostatic voltmeter should be available.

The test steps for this setup are:

1. Raise dc power supply voltage until the lamp under test fires.
2. Adjust R until specified lamp current is obtained.
3. Adjust the height of the negative pulse coming from the pulse generator until the voltage across the lamp is zero during OFF time.
4. Adjust the width of the negative dc pulse to increase the lamp OFF time until the lamp refuses to turn ON. The OFF dwell that just inhibits the lamp from turning on should be recorded.
5. Using a series of 1-v steps below breakdown, repeat the previous four steps.

Data should be obtained for rated lamp current and for 0.5 and 2 times rated current for each lamp. A few lamps from each lot should be tested to assure a statistical sampling. The data from his test should also be treated statistically to determine the families of refiring voltages vs time OFF curves with constant ambient light and lamp current.

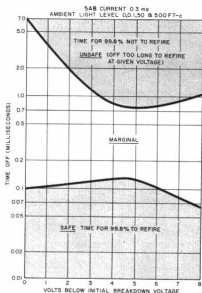

Fig. 5.12. Time-off as a function of refiring voltage.

Shown in Fig. 5.12 are the envelope curves for the 5AB neon, at the 3σ limits. From this figure the designer can readily see where the *safe* (lower) *marginal* (middle) and *unsafe* (upper) areas of operation occur.

Current was held constant for the tests that produced these levels and in this case it was found that the light levels did not significantly alter the refiring time.

NOTES



GENERAL ELECTRIC GLOW LAMP SPECIFICATIONS

From the first glow lamp, (NE-2), have evolved the scores of lamps in today's glow lamp line, each with specific characteristics depending upon the job to be done. Thus size, light output, life, efficiency, breakdown voltage, maintaining voltage, extinguishing potential and many other factors are considered in designing just the right lamp for the specific application.

As an aid in selecting the right lamp — before the design of the product is frozen — choice can be narrowed down to lamps typical of the application. These become the clues which may permit you to make easier selection from the glow lamp specifications that follow.

| CIRCUIT | SUGGESTED LAMP TYPES |
|---------------------------|----------------------|
| Logic AND-OR Gates | 3AG & 5AB |
| Memory Circuits | 5AH, 4AB, 4AC |
| Multivibrators | 3AG, 5AB, & 5AG |
| Photoconductor Activators | 3AH, 5AH & 5AJ |
| Sawtooth Oscillators | 3AG, 5AB & 5AG |
| Trigger Circuits | 4AB, 4AC, 5AH |
| Voltage Indicators | 3AG, 5AB & 5AG |
| Voltage Regulators | 3AC, 3AH, 3AJ |

The specifications give a brief description, the outline drawing, the electrical characteristics and aging instructions for each circuit component lamp. Additional information about lamp characteristics and operation in specific circuits may be obtained from G.E. Representatives, listed below, or the editors of this book.

GENERAL ELECTRIC MINIATURE LAMP SALES OFFICES

| Address | (Zip) | (Telephone) | Address | (Zip) | (Telephone) |
|---------------------|---|----------------|----------------------|--|-------------------------|
| Atlanta, Ga. | Suite 2B, 359 East Paces Ferry Rd., N.E. | 30305 237-0795 | Memphis, Tenn. | 2021 S. Latham St. | 38109 948-2642 |
| Baltimore, Md. | 1401 Parker Road Mail: P.O. Box 7427 Arbutus, Md. | 21227 242-5700 | Miami, Fla. | 1310 N.W. 74th St. Mail: P.O. Box 12 | 33143 757-8481 33157 |
| Boston, Mass. | 50 Industrial Place, Newton Upper Falls, Mass. | 02164 332-6200 | Milwaukee, Wis. | 8100 W. Florist Ave. | 53209 462-3860 |
| Cape Elizabeth, Me. | 29 Ocean View Rd. | 04107 799-0221 | Minneapolis, Minn. | 500 Stinson Blvd. | 55413 331-4050 |
| Charlotte, N. C. | 1001 Tuckaseegee Rd. Mail: P.O. Box 17362 | 28211 376-6585 | Moorhead, Minn. | 1210-19½ St. South | 56560 233-5712 |
| Chicago, Ill. | 550 W. Jackson Blvd. | 60606 332-4712 | Newark, N. J. | 133 Boyd St. | 07103 824-5200 |
| Cincinnati, Ohio | 49 Central Ave. | 45202 421-6810 | New Orleans, La. | 4800 River Rd., Mail: Box 10236, Jefferson Branch | 70121 835-6421 |
| Cleveland, Ohio | 12910 Taft Ave. Mail: P.O. Box 2514 | 44108 266-4337 | New York, N. Y. | 219 E. 42 St. | 10017 751-1311 |
| Columbus, Ohio | 766 Northwest Blvd. | 43212 294-4115 | Oakland, Calif. | 999-98th Avenue | 94603 569-3422 |
| Dallas, Texas | 6500 Cedar Springs Rd. Mail: P.O. Box 35425 | 75235 351-3725 | Oklahoma City, Okla. | Executive Terrace Bldg., 2809 N.W. Expressway | 73116 842-4028 |
| Dayton, Ohio | 225 N. Wilkinson St. | 45402 223-7151 | Philadelphia, Pa. | Rt. 202, At Express- way, King of Prussia, Pa. | 19406 688-5900 |
| Denver, Colo. | 6501 E. 44th Ave. | 80216 388-4611 | Pittsburgh, Pa. | 238 W. Carson St. | 15219 471-9050 |
| Detroit, Mich. | 15135 Hamilton Ave. | 48203 883-0200 | Rochester, N. Y. | Gibbs St. Bldg., 31 Gibbs St., Room 500 | 14604 454-2990 |
| Duluth, Minn. | 126 N. 7th Ave. East | 55805 722-5549 | Rock Island, Ill. | 101-31 Street, Mail: P.O. Box 66 | 61202 788-3405 |
| El Paso, Texas | 2800 North Stanton, Room 210 | 79902 533-1961 | St. Louis, Mo. | 1530 Fairview Ave. | 63132 429-6930 |
| Houston, Texas | 5615 Lymbar Drive | 77035 923-2549 | Seattle, Wash. | 2400 6th Ave., South | 98104 622-8081 |
| Indianapolis, Ind. | 2511-F-1 East 46 St. | 46205 547-5511 | Springfield, Mass. | 120 Maple Street. | 01103 734-5606 |
| N. Kansas City, Mo. | 535 East 14th Ave. | 64116 471-0123 | Utica, N. Y. | c/o Radio Receiver Dept., P.O. Box 175, 1001 Broad St. | 13501 724-1293 |
| Los Angeles, Calif. | 2747 S. Malt Ave. | 90022 723-2541 | West Haven, Conn. | 86 Tyler Ave. | 06516 562-9828 |

**CROSS REFERENCE AND SUBSTITUTION GUIDE FOR
G.E. CIRCUIT COMPONENT GLOW LAMPS**

(MEMO'S)

ARGONS ARE AR
SERIES

The Miniature Lamp Department of the General Electric company recognized the need for a new numbering system for circuit component glow lamps which will be compatible with the new ASA system for indicator glow lamps. Shown below is a cross reference and substitution guide.

| OLD | NEW | SUBSTITUTION |
|--------|-------|--------------|
| NE-2AS | | 3AD |
| NE-2L | | 3AD |
| NE-2LT | | 3AD |
| NE-2S | | 5AB-A |
| NE-3 | 8AA | |
| NE-4 | 8AB | |
| NE-5 | 8AC | |
| NE-16 | 7AA | |
| NE-23 | 5AB | |
| NE-51S | | |
| NE-67 | 6AC | NE 51 |
| NE-68 | 5AC | |
| NE-68A | | 5AC |
| NE-75 | | 3AD |
| NE-76 | 5AG-A | |
| NE-77 | 5BA | |
| NE-80 | | 5AG |
| NE-81 | 5AG | |
| NE-83 | 5AH | |
| NE-86 | 5AJ | |
| NE-96 | 4AB | |
| NE-97 | 4AC | |
| NE-98 | | 3AD |
| NE-99 | 2AA | |

pg 99

Pg 104

" 115

pg 116

Pg 113

PAGE 98

Pg 112

PAGE 102

Pg 104

Pg 103

Pg 105

Pg 109

PAGE 96

97

SEE PAGE 117 FOR NE 214
NE 51
ETC

2AA

(NE-99)

The 2AA is the smallest circuit component presently available. The formed tip gives good end-on viewing. A radioactive additive reduces dark effect.

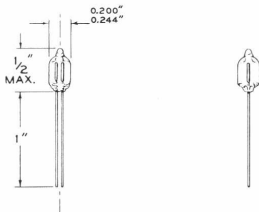
OUTLINE DRAWING**SPECIFICATIONS**

| | Min. | Avg. | Max. |
|--|------|-------|------|
| Initial DC Breakdown Voltage (In dark) | 60 | | 80 |
| Initial DC Maintaining Voltage @ 0.3 ma | 52 | | 62 |
| Hours operation @ 0.3 ma for 6 volt change in maintaining voltage | | 7,500 | |
| Design current in millamperes | | 0.3 | |

Aging Procedure - 100 hours at design current or 24 hours at 0.6 ma; followed by 24 hours under typical circuit operating conditions.

The 3AD is a selected version of the 3AG which finds wide usage as a stereo indicator. This lamp has specified voltage ranges, tinned leads, an extinguishing test, mild radioactive additive for the reduction of dark effect, and Dri-Film coating for high leakage resistance.

3AD
(NE-98)

OUTLINE DRAWING

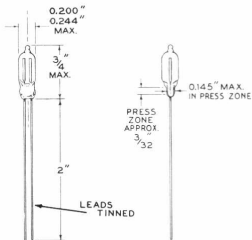

SPECIFICATIONS

| | Min. | Avg. | Max. |
|--|---------------|-------|------|
| Initial DC Breakdown Voltage (In 5-50 footcandles) | 65 | | 80 |
| Initial DC Maintaining Voltage @ 0.3 ma | | >50 | |
| Hours operation @ 0.3 ma for 5 volt change in breakdown or maintaining voltage | | 6,000 | |
| Design current in millamperes | | 0.3 | |
| Extinguishing voltage (.25M Ω or more series resistance) | 50 | | |
| Leakage resistance @ 80°F and 75% Relative Humidity | 100M Ω | | |

Aging Procedure - 100 hours at design current or 24 hours at 0.6 ma.; followed by 24 hours under typical circuit operating conditions.

3AG

of the lower priced neons.

The 3AG is a standard brightness circuit component lamp. It incorporates a shorter overall length than most glow lamps, a formed tip for easier end-on viewing, and a mild radioactive additive for the reduction of dark effect. It is one

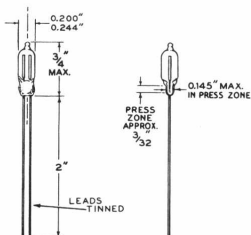

SPECIFICATIONS

| | Min. | Avg. | Max. |
|--|------|-------|------|
| Initial DC Breakdown Voltage (In 5-50 footcandles) | 60 | 76 | 90 |
| Initial DC Maintaining Voltage @ 0.4 ma | 46 | 58 | 76 |
| Hours operation @ 0.4 ma for 5 volt change in breakdown or maintaining voltage | | 2,000 | |
| Design current in millamperes | | 0.4 | |

Aging Procedure - 100 hours at design current or 24 hours at 0.8 ma.; followed by 24 hours under typical circuit operating conditions.

The 3AG-A is a preaged 3AG. A breakdown and maintaining test has been added along with an extinguishing voltage test and Dri-Film coating to increase leakage resistance.

3AG-A

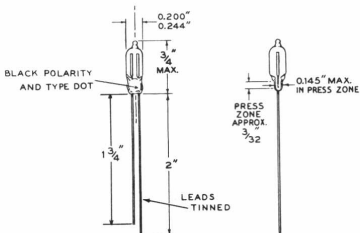

SPECIFICATIONS

| | Min. | Avg. | Max. |
|--|-------|-------|------|
| Initial DC Breakdown Voltage (In 5-50 footcandles) | 60 | | 80 |
| Initial DC Maintaining Voltage @ 0.4 ma | 50 | | 65 |
| Hours operation @ 0.4 ma for 5 volt change in breakdown or maintaining voltage | | 6,000 | |
| Design current in millamperes | | 0.3 | |
| Extinguishing Voltage (.25 MegΩ or more series resistance) | 50 | | |
| Leakage resistance at 80°F and 75% Relative Humidity | 100MΩ | | |

Aging Procedure - Not required as lamp is pre-aged.

3AG-B

The 3AG-B is a selected version of the 3AG-A. Where closer voltage specifications are required this lamp is one of the logical choices over the 3AG-A.

OUTLINE DRAWING

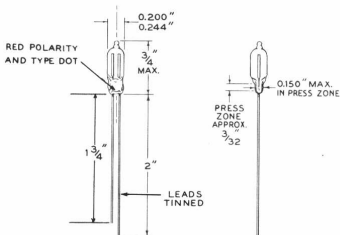

SPECIFICATIONS

| | Min. | Avg. | Max. |
|--|-------|-------|------|
| Initial DC Breakdown Voltage (In 5-50 footcandles) | 65 | | 73 |
| Initial DC Maintaining Voltage @ 0.4 ma | 52 | | 62 |
| Hours operation @ 0.4 ma for 5 volt change in breakdown or maintaining voltage | | 2,000 | |
| Design current in milliamperes | | 0.4 | |
| Extinguishing voltage (.25 MegΩ or more series resistance) | 50 | | |
| Leakage resistance @ 80°F and 75% Relative Humidity | 100MΩ | | |

Aging Procedure - Not required as lamp is pre-aged.

The 3AG-C is also a selected version of the 3AG-A. Selection to a slightly higher range has advantages in some circuits and the differential between breakdown and maintaining voltage is higher than the 3AG-B.

3AG-C

OUTLINE DRAWING

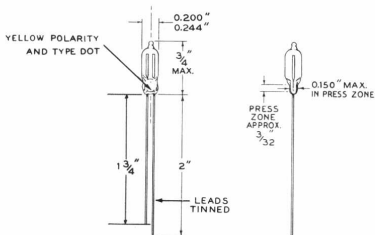

SPECIFICATIONS

| | Min. | Avg. | Max. |
|--|---------------|-------|------|
| Initial DC Breakdown Voltage (In 5-50 footcandles) | 68 | | 76 |
| Initial DC Maintaining Voltage @ 0.4 ma | 52 | | 62 |
| Hours operation @ 0.4 ma for 5 volt change in breakdown or maintaining voltage | | 2,000 | |
| Design current in millamperes | | 0.4 | |
| Extinguishing voltage (.25 Meg Ω or more series resistance) | 50 | | |
| Leakage resistance @ 80°F and 75% Relative Humidity | 100M Ω | | |

Aging Procedure - Not required as lamp is pre-aged.

3AH

The 3AH lamp is a high brightness circuit component lamp with Dri-Film for increased leakage resistance. This lamp is recommended for applications where stability of characteristics is not a major design criteria. The formed tip provides an overall length which is shorter than many glow lamps, as well as better end-on viewing, where desired. A radioactive additive is present to reduce dark effect.

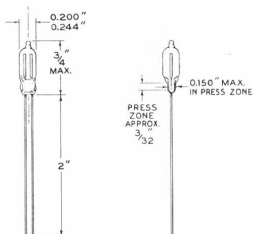
OUTLINE DRAWING**SPECIFICATIONS**

| | Min. | Avg. | Max. |
|---|--------|-------|------|
| Initial DC Breakdown Voltage (In 5-50 footcandles) | 75 | 105 | 135 |
| Initial DC Maintaining Voltage @ 2.0 ma | 55 | 70* | 105 |
| Hours operation @ 2.0 ma for 10 volt change in breakdown or maintaining voltage | | 2,000 | |
| Design current in millamperes | | 2.0 | |
| Leakage resistance @ 80°F and 75% Relative Humidity | 100 MΩ | | |

*After 100 hours operation at design current. Individual lots may vary from average.

Aging Procedure - 100 hours at design current or 15 minutes at 15-17 ma.; followed by 24 hours under typical circuit operating conditions.

The 4AB has the largest differential between breakdown and maintaining voltage of any GE glow lamp. Although ideal for triggered pulse applications where a single, higher voltage output is desired, the instabilities inherent in this lamp type could rule against its use in some circuits. The lamp contains radioactive additive for the reduction of dark effect. The light output is not high but with end-on viewing it is adequate for normal observations.

4AB
(NE-96)

OUTLINE DRAWING

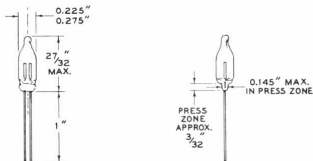

SPECIFICATIONS

| | Min. | Avg. | Max. |
|---|------|-------|------|
| Initial DC Breakdown Voltage (In 5-50 footcandles) | 120 | | 150 |
| Initial DC Maintaining Voltage @ 0.5 ma | 60 | | 80 |
| Hours operation @ 0.5 ma for 10 volt change in breakdown or maintaining voltage | | 3,000 | |
| Design current in millamperes | | 0.5 | |

Aging Procedure - 100 hours at design current or 7 hours at 1.25 ma.; followed by 24 hours under typical circuit operating conditions.

4AC

(NE-97)

The 4AC has a somewhat smaller differential between breakdown and maintaining voltage than does the 4AB, but operating stability has been improved in this lamp type and response time is somewhat faster. A radioactive additive is included.

OUTLINE DRAWING

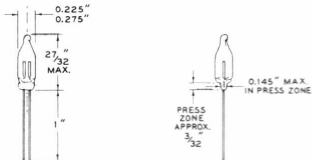

SPECIFICATIONS

| | Min. | Avg. | Max. |
|---|------|-------|------|
| Initial DC Breakdown Voltage (In 5-50 footcandles) | 110 | | 140 |
| DC Maintaining Voltage @ 0.5 ma | 60 | | 80 |
| Hours operation @ 0.5 ma for 10 volt change in breakdown or maintaining voltage | | 3,000 | |
| Design current in millamperes | | 0.5 | |

Aging Procedure - 100 hours at design current or 2 hours at 1.25 ma.; followed by 24 hours under typical circuit operating conditions.

The 5AB is a modification of the NE-2 indicator lamp with mild radioactive additive for the reduction of dark effect. Both its low cost and stable characteristics following aging account for its popularity.

5AB
(NE-23)

OUTLINE DRAWING

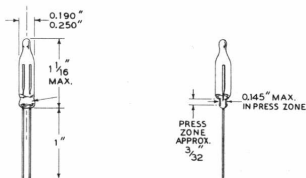

SPECIFICATIONS

| | Min. | Avg. | Max. |
|--|------|-------|------|
| Initial DC Breakdown Voltage (In 5-50 footcandles) | 60 | 74 | 90 |
| DC Maintaining Voltage @ 0.3 ma | | 59* | |
| Hours operation @ 0.3 ma for 5 volt change in breakdown or maintaining voltage | | 6,000 | |
| Design current in millamperes | | 0.3 | |

* After 100 hours operation at design current. Individual lots may vary from average.

Aging Procedure - 100 hours at design current or 24 hours at 0.6 ma.; followed by 24 hours under typical operating conditions.

5AB-A

NEZS

The 5AB-A is a pre-aged 5AB. A breakdown and maintaining voltage test has been added along with an extinguishing voltage test. Dri-Film coating increases the leakage resistance. This is the least expensive pre-aged circuit component in the line.

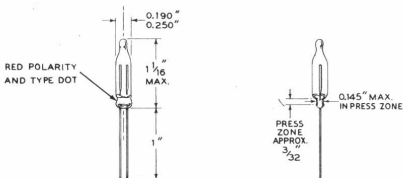
OUTLINE DRAWING**SPECIFICATIONS**

| | Min. | Avg. | Max. |
|--|----------------|-------|------|
| Initial DC Breakdown Voltage (In 5-50 footcandles) | 60 | | 80 |
| DC Maintaining Voltage @ 0.3 ma | 50 | | 65 |
| Hours operation @ 0.3 ma for 5 volt change in breakdown or maintaining voltage | | 6,000 | |
| Design current in millamperes | | 0.3 | |
| Extinguishing voltage (.25 Meg Ω or more series resistance) | 50 | | |
| Leakage resistance @ 80°F and 75% Relative Humidity | 100 M Ω | | |

Aging Procedure - Not required as lamp is pre-aged.

The 5AB-B is a selected version of the 5AB-A. Where closer voltage specifications are required this is one of the logical choices over the 5AB-A.

5AB-B

OUTLINE DRAWING

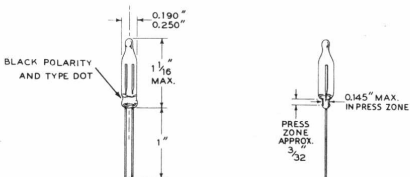

SPECIFICATIONS

| | Min. | Avg. | Max. |
|--|-------|-------|------|
| Initial DC Breakdown Voltage (In 5-50 footcandles) | 62 | | 72 |
| DC Maintaining Voltage @ 0.3 ma | 50 | | 60 |
| Hours operation @ 0.3 ma for 5 volt change in breakdown or maintaining voltage | | 6,000 | |
| Design current in millamperes | | 0.3 | |
| Extinguishing voltage (.25 MΩ or more series resistance) | 50 | | |
| Leakage resistance @ 80°F and 75% Relative Humidity | 100MΩ | | |

Aging Procedure - Not required as lamp is pre-aged.

5AB-C

The 5AB-C is also a selected version of the 5AB-A. Slightly higher breakdown and maintaining range will give advantages in some circuits.

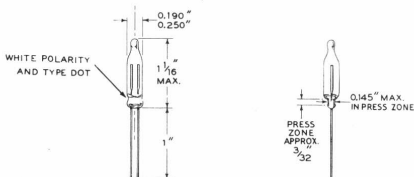
OUTLINE DRAWING**SPECIFICATIONS**

| | Min. | Avg. | Max. |
|--|--------|-------|------|
| Initial DC Breakdown Voltage (In 5-50 footcandles) | 68 | | 78 |
| DC Maintaining Voltage @ 0.3 ma | 55 | | 65 |
| Hours operation @ 0.3 ma for 5 volt change in breakdown or maintaining voltage | | 6,000 | |
| Design current in millamperes | | 0.3 | |
| Extinguishing voltage (.25 MΩ or more series resistance) | 50 | | |
| Leakage resistance @ 80°F and 75% relative Humidity | 100 MΩ | | |

Aging Procedure - Not required as lamp is pre-aged.

The 5AC is designed primarily for voltage regulation purposes. This lamp is recommended for those applications where a partially stabilized lamp is required. The lamp contains a mild radioactive additive.

5AC
(NE-68)

OUTLINE DRAWING

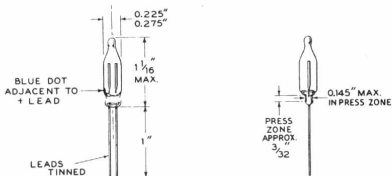

SPECIFICATIONS

| | Min. | Avg. | Max. |
|--|--------|-------|------|
| Initial DC Breakdown Voltage (In 5-50 footcandles) | 60 | | 90 |
| Initial DC Maintaining Voltage @ 0.3 ma | 52 | | 65 |
| Hours operation @ 0.3 ma for 5 volt change in breakdown or maintaining voltage | | 2,000 | |
| Design current in millamperes | | 0.3 | |
| Extinguishing voltage (.25 MΩ or more series resistance) | 50 | | |
| Leakage resistance @ 80°F and 75% Relative Humidity | 100 MΩ | | |

Aging Procedure - Not required as lamp is partially pre-aged.

5AG

(NE-81)

The 5AG is closely related to the 5AG-A, but has somewhat wider tolerance on breakdown voltage. It too, is pre-aged and contains a mild radioactive additive, has Dri-Film coating, and an extinguishing voltage test. This lamp is rated @ 0.1 & 0.3 ma.

OUTLINE DRAWING

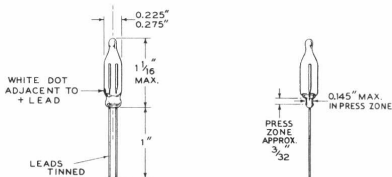

SPECIFICATIONS

| | Min. | Avg. | Max. |
|--|--------|---------|------|
| Initial DC Breakdown Voltage (In 5-50 footcandles) | 64 | | 80 |
| Initial DC Maintaining Voltage @ 0.3 ma | 50 | | 60 |
| Initial DC Maintaining Voltage @ 0.1 ma | 50 | | 58 |
| Hours operation @ 0.3 ma for 5 volt change in breakdown voltage | | 2,000 | |
| Hours operation @ 0.1 ma for 5 volt change in maintaining voltage | | 2,000 | |
| Design current in millamperes | | 0.1-0.3 | |
| Extinguishing voltage (.25 MΩ or more series resistance) | 50 | | |
| Leakage resistance @ 80°F and 75% Relative Humidity | 100 MΩ | | |

Aging Procedure - Not required as lamp is pre-aged.

This neon lamp has the tightest breakdown voltage tolerance — ± 4 volts — of all GE glow lamps. Maintaining voltage is also held within ± 5 volts. The lamps are all pre-aged, polarity marked, and contain a mild radioactive additive for the reduction of dark effects. The tight voltage characteristics and pre-aging treatment ideally suit this lamp for use in multivibrators, relaxation oscillators and other close tolerance applications.

5AG-A
(NE-76)

OUTLINE DRAWING

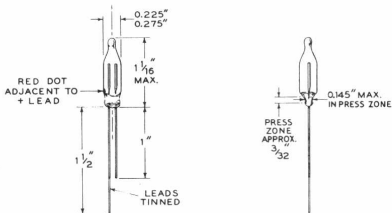

SPECIFICATIONS

| | Min. | Avg. | Max. |
|---|--------|----------------|------|
| Initial DC Breakdown Voltage (In 5-50 footcandles) | 68 | | 76 |
| Initial DC Maintaining Voltage @ 0.4 ma | 50 | | 60 |
| Breakdown voltage to stay within initial specs when operated at 0.4 ma | | 1,000 hours | |
| Hours operation @ 0.4 ma for 5 volt change in maintaining voltage | | 2,000 | |
| Design current in millamperes | | 0.4 | |
| Extinguishing voltage (.25 MΩ or more series resistance) | 50 | | |
| Leakage resistance @ 80°F and 75% Relative Humidity | 100 MΩ | | |

Aging Procedure - Not required as lamp is pre-aged.

5AH

(NE-83)

This "high-current" lamp shows promise wherever greater current carrying capacity is required. The lamp's differential between breakdown and maintaining volts is somewhat greater than the 5AB family, but not as large as is the case for the 4AB and 4AC. Its voltage regulation properties also merit attention. The lamp contains radioactive additive. The 5AH family finds many used in pulsed circuits — such as SCR triggers. Dri-Film is used to increase the leakage resistance.

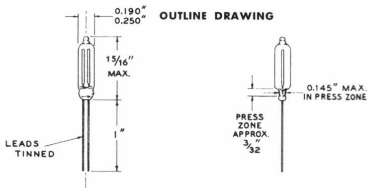

SPECIFICATIONS

| | Min. | Avg. | Max. |
|---|--------|----------|------|
| Initial DC Breakdown Voltage (In 5-50 footcandles) | 60 | | 100 |
| DC Maintaining Voltage @ 10.0 ma | | 62* | |
| DC Maintaining Voltage @ 5.0 ma | | 60* | |
| Hours operation @ 10.0 ma for 5 volt change in breakdown or maintaining voltage | | 500 | |
| Hours operation @ 5.0 ma for 5 volt change in breakdown or maintaining voltage | | 5,000 | |
| Design current in milliamperes | 1.5 | 5.0-10.0 | |
| Leakage resistance @ 80°F and 75% Relative Humidity | 100 MΩ | | |

* Average after 100 hours operation at design current. Individual lots may vary from average.

Aging Procedure - 100 hours at design current or 24 hours at 15 milliamperes; followed by 24 hours under typical circuit operating conditions.

The 5AH-A is a selected version of the 5AH. The low breakdown spec allows its use in the low voltage circuits. All other characteristics are similar to the 5AH.

5AH-A

OUTLINE DRAWING

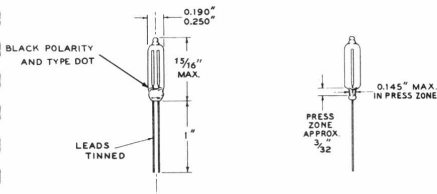

SPECIFICATIONS

| | Min. | Avg. | Max. |
|---|--------|----------|------|
| Initial DC Breakdown Voltage (In 5-50 footcandles) | 60 | | 85 |
| DC Maintaining Voltage @ 10.0 ma | 52 | | 67 |
| DC Maintaining Voltage @ 5.0 ma | 50 | | 65 |
| Hours operation @ 10.0 ma for 5 volt change in breakdown or maintaining voltage | | 500 | |
| Hours operation @ 5.0 ma for 5 volt change in breakdown or maintaining voltage | | 5,000 | |
| Design current in millamperes | 1.5 | 5.0-10.0 | |
| Leakage resistance @ 80°F and 75% Relative Humidity | 100 MΩ | | |

Aging Procedure - 100 hours at design current or 24 hours at 15 milliamperes; followed by 24 hours under typical circuit operating conditions.

5AH-B

The 5AH-B is a selected 5AH with a 10v spread on breakdown and 8v spread on maintaining voltage. The differential at 7v between breakdown and maintaining voltage allow circuit designer more latitude with other components.

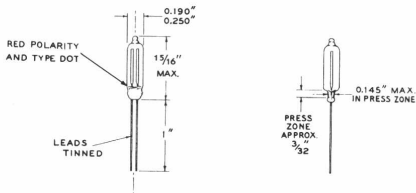
OUTLINE DRAWING**SPECIFICATIONS**

| | Min. | Avg. | Max. |
|---|--------|----------|------|
| Initial DC Breakdown Voltage (In 5-50 footcandles) | 75 | 80 | 85 |
| DC Maintaining Voltage @ 10.0 ma | 60 | 64 | 68 |
| DC Maintaining Voltage @ 5.0 ma | 58 | 62 | 66 |
| Hours operation @ 10.0 ma for 5 volt change in breakdown or maintaining voltage | | 500 | |
| Hours operation @ 5.0 ma for 5 volt change in breakdown or maintaining voltage | | 5,000 | |
| Design current in millamperes | 1.5 | 5.0-10.0 | |
| Leakage resistance @ 80°F and 75% Relative Humidity | 100 MΩ | | |

Aging Procedure - 100 hours at design current or 24 hours at 15 milliamperes; followed by 24 hours under typical circuit operating conditions.

The 5AH-C is also a selected 5AH. The higher breakdown voltage spec allows this lamp to be used in special circuits. The guaranteed differential of 8v gives higher energy pulses in trigger circuits.

5AH-C

OUTLINE DRAWING

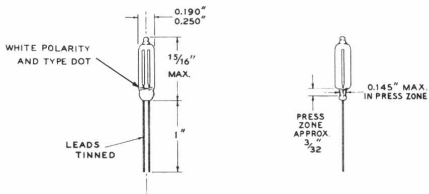

SPECIFICATIONS

| | Min. | Avg. | Max. |
|--|--------|----------|------|
| Initial DC Breakdown Voltage (In 5-50 footcandles) | 75 | | 100 |
| DC Maintaining Voltage @ 10.0 ma | 52 | | 67 |
| DC Maintaining Voltage @ 5.0 ma | 50 | | 65 |
| Hours operation @ 10 ma for 5 volt change in breakdown or maintaining voltage | | 500 | |
| Hours operation @ 5.0 ma for 5 volt change in breakdown or maintaining voltage | | 5,000 | |
| Design current in millamperes | 1.5 | 5.0-10.0 | |
| Leakage resistance @ 80°F and 75% Relative Humidity | 100 MΩ | | |

Aging Procedure - 100 hours at design current or 24 hours at 15 milliamperes; followed by 24 hours under typical circuit operating conditions.

5AJ

(NE-86)

The 5AJ, rated at 1.5 ma., ranks between the 5AB family of lamps and the 5AH family in current handling capacity. Its voltage characteristics and the appearance of its glow discharge, are closer to the 5AB than the 5AH. The lamp contains a radioactive additive for the reduction of dark effect.

OUTLINE DRAWING

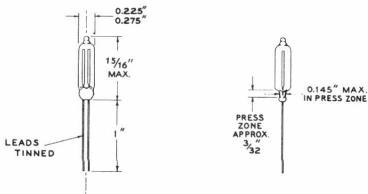

SPECIFICATIONS

| | Min. | Avg. | Max. |
|--|--------|-------|------|
| Initial DC Breakdown Voltage (In 5-50 footcandles) | 55 | | 90 |
| DC Maintaining Voltage @ 1.5 ma | | 57* | |
| Hours operation @ 1.5 ma for 5 volt change in breakdown or maintaining voltage | | 2,000 | |
| Design current in millamperes | | 1.5 | |
| Leakage resistance @ 80°F and 75% Relative Humidity | 100 MΩ | | |

* Average after 100 hours operation at design current. Individual lots may vary from average.

Aging Procedure - 100 hours at design current followed by 24 hours under typical circuit operating conditions.

The 5AJ-A is a selected version of the 5AJ. The low breakdown voltage will reduce power supply requirements in same cases.

5AJ-A

OUTLINE DRAWING

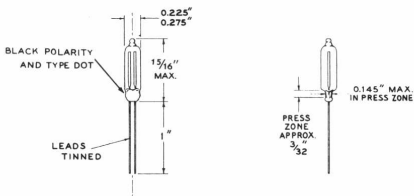

SPECIFICATIONS

| | Min. | Avg. | Max. |
|--|--------|-------|------|
| Initial DC Breakdown Voltage (In 5-50 footcandles) | 55 | | 75 |
| DC Maintaining Voltage @ 1.5 ma | 45 | | 65 |
| Hours operation @ 1.5 ma for 5 volt change in breakdown or maintaining voltage | | 2,000 | |
| Design current in millamperes | | 1.5 | |
| Leakage resistance @ 80°F and 75% Relative Humidity | 100 MΩ | | |

Aging Procedure - 100 hours at design current followed by 24 hours under typical circuit operating conditions.

5AJ-B

The 5AJ-B is also a selected version of the 5AJ. The higher breakdown voltage spec will allow its use in special circuits.

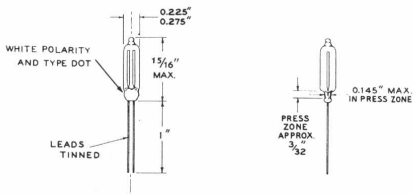
OUTLINE DRAWING**SPECIFICATIONS**

| | Min. | Avg. | Max. |
|--|--------|-------|------|
| Initial DC Breakdown Voltage (In 5-50 footcandles) | 70 | | 90 |
| DC Maintaining Voltage @ 1.5 ma | 55 | | 75 |
| Hours operation @ 1.5 ma for 5 volt change in breakdown or maintaining voltage | | 2,000 | |
| Design current in millamperes | | 1.5 | |
| Leakage resistance @ 80° F and 75% Relative Humidity | 100 MΩ | | |

Aging Procedure - 100 hours at design current followed by 24 hours under typical circuit operating conditions.

The NE-67 is a modification of the NE-51 indicator lamp with Dri-Film coating incorporated within the base. This Dri-Film counteracts the leakage resistance problem inherent in many based lamps because of conduction across the basing cements.

6AC
(NE-67)

OUTLINE DRAWING

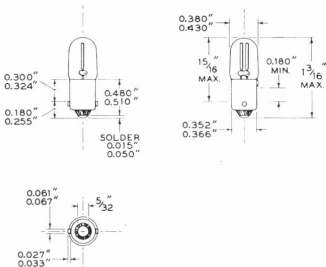

SPECIFICATIONS

| | Min. | Avg. | Max. |
|--|--------|-------|------|
| Initial DC Breakdown Voltage (In 5-50 footcandles) | 55 | 64* | 90 |
| DC Maintaining Voltage @ 0.2 ma | | 56* | |
| Hours operation @ 0.2 ma for 5 volt change in breakdown or maintaining voltage | | 1,000 | |
| Design current in millamperes | | 0.2 | |
| Leakage resistance at 80°F and 75% Relative Humidity | 100 MΩ | | |

* Average after 100 hours operation at design current. Individual lots may vary from average.

Aging Procedure - 100 hours at design current followed by 24 hours under typical circuit operating conditions.

7AA

(NE-16)

The 7AA (NE-16) is intended primarily for voltage regulation applications. It meets the requirements of MIL-E-1/283 for the JAN 991 regulator tube. A mild radioactive additive for the reduction of dark effect is included in the lamp.

OUTLINE DRAWING

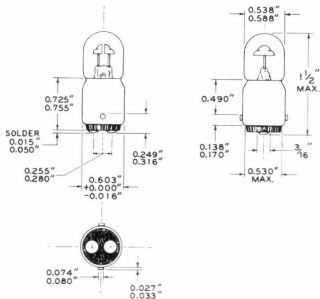

SPECIFICATIONS

| | Min. | Avg. | Max. |
|---|------|-------|------|
| Initial DC Breakdown Voltage (In 5-50 footcandles) | 67 | | 87 |
| Initial DC Maintaining Voltage @ 1.5 ma | 53 | | 65 |
| Hours operation @ 1.5 ma for break- down voltage to remain below 95V DC and maintaining voltage to re- main below 70V DC | | 1,000 | |
| Design current in millamperes | | 1.5 | |

Aging Procedure - 100 hours at design current or 24 hours at 2 ma.; followed by 24 hours under typical circuit operating conditions.

A neon lamp utilizing a clear round-end bulb mounted in a telephone slide base. The round-end bulb provides undistorted end-on viewing. The telephone slide base is one solution to front-end replacement of panel mounted lighting units.

8AA
(NE-3)

OUTLINE DRAWING

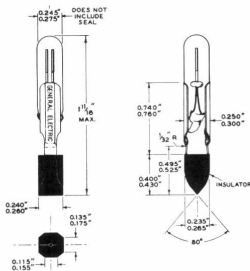

SPECIFICATIONS

| | Min. | Avg. | Max. |
|---|------|------|------|
| Initial DC Breakdown Voltage (In 5-50 footcandles) | 55 | | 90 |
| DC Maintaining Voltage @ 0.3 ma | | 55* | |
| Life - Breakdown voltage to stay within initial limits and maintaining voltage to stay above 100 hours limit for 15,00 hours at 0.3 ma | | | |
| Design current in millamperes | | 0.3 | |
| Extinguishing Voltage (.25 Meg Ω or more series resistance) | 50 | | |

*After 100 hours operation at design current. Individual lots may vary from average.

Aging Procedure - 100 hours at design current or 24 hours at 0.6 milliamperes; followed by 24 hours under typical circuit operating conditions.

8AB

(NE-4)

The 8AB is a combination of the random-tipped NE-2 lamp and the telephone slide base. It offers the same front-end accessibility as the 8AA and is lower in price.

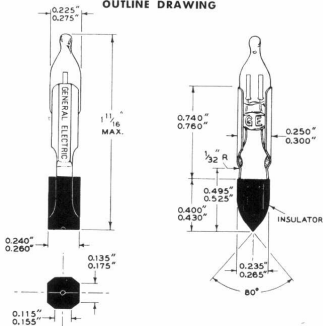
OUTLINE DRAWING**SPECIFICATIONS**

| | Min. | Avg. | Max. |
|--|------|-------|------|
| Initial DC Breakdown Voltage (In 5-50 footcandles) | 60 | 70* | 90 |
| Initial DC Maintaining Voltage @ 0.3 ma | 44 | 59* | 74 |
| Hours operation @ 0.3 ma for 5 volt change in breakdown or maintaining voltage | | 6,000 | |
| Design current in milliamperes | | 0.3 | |

*After 100 hours operation at design current. Individual lots may vary from average.

Aging Procedure - 100 hours at design current or 24 hours at 0.6 milliamperes; followed by 24 hours under typical circuit operating conditions.

The 8AC lamp is the 4AB with telephone slide base. It is designed for those applications where a replaceable lamp is a necessity. The wide differential between breakdown and maintaining voltage suggests this lamp for those applications where maximum output signal is desired. A mild radioactive additive is included in the lamp.

8AC
(NE-5)

OUTLINE DRAWING

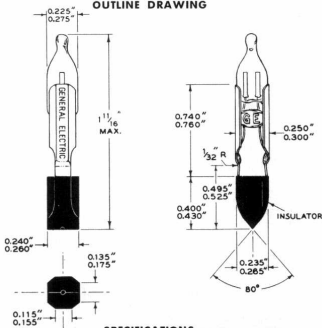

SPECIFICATIONS

| | Min. | Avg. | Max. |
|---|------|-------|------|
| Initial DC Breakdown Voltage (In 5-50 footcandles) | 120 | | 150 |
| Initial DC Maintaining Voltage @ 0.5 ma | 60 | | 80 |
| Hours operation @ 0.5 ma for 1% volt change in breakdown or maintaining voltage | | 3,000 | |
| Design current in millamperes | | 0.5 | |

Aging Procedure - 100 hours at design current or 7 hours at 1.25 milliamps; followed by 24 hours under typical circuit operating conditions.

GENERAL ELECTRIC GLOW LAMPS FOR INDICATOR USE . . .

| Lamp Number (l) | Package Quantities Unit | Standard | Average Useful Life, Hours (d) | External (e): Resistance Resistor(ohms) | M.O.L. Inches | Base | Bulb (Clear) | Nominal Current, Ma. | Circuit Volts AC or DC | Watts, Nominal (e) |
|----------------------------------|-------------------------|----------|--------------------------------|---|---------------|------------------|--------------|----------------------|------------------------|--------------------|
| HIGH BRIGHTNESS LAMPS | | | | | | | | | | |
| A1C | 100 | 1000 | \$5,000(h) | 68K | 1/2(a) | 1" wire term. | T-8(a) | 0.8 | 105-125(i) | 1/10 |
| A1H | 10 | 100 | \$5,000(h) | 68K | 3/8 | S.C. Mid. Flange | T-8(a) | 0.8 | 105-125(i) | 1/10 |
| B9A (NE-51H) | 10 | 100 | over \$5,000(h) | 47K | 1 1/2(b) | Min. Bay. | T-3 1/2 | 1.2 | 105-125(i) | 1/7 |
| C9A (NE-3H) | 100 | 1000 | \$5,000(h) | 30K(j) | 3/8(a) | 2" wire term. | T-9(a) | 1.9 | 105-125(i) | 1/4 |
| K1A (NE-84) | 10 | 100 | \$5,000(h) | 30K(j) | 1 1/2 | S.C. Mid. Flange | T-9(a) | 1.9 | 105-125(i) | 1/4 |
| K1D | 10 | 100 | \$5,000(h) | 30K(j) | 1.030 | ASA #5 I.S.B. | T-9(a) | 1.9 | 105-125(i) | 1/4 |
| K3A (NE-2P) | 10 | 100 | \$5,000(h) | 30K(j) | 3/8(a) | 1" wire term. | T-8(c) | 1.9 | 105-125(i) | 1/4 |
| STANDARD BRIGHTNESS LAMPS | | | | | | | | | | |
| A1A (NE-2) | 100 | 1000 | \$5,000 | 150K | 1 1/2(a) | 1" wire term. | T-8 | 0.5 | 105-125 | 1/17 |
| A1E | 100 | 1000 | \$5,000 | 220K | 1/2(a) | 1" wire term. | T-8(a) | 0.3 | 105-125 | 1/25 |
| A1G | 10 | 100 | \$5,000 | 220K | 3/8 | S.C. Mid. Flange | T-8(a) | 0.3 | 105-125 | 1/25 |
| A8B (NE-2V) | 100 | 1000 | \$5,000(h) | 100K | 3/8(a) | 2" wire term. | T-9(a) | 0.7 | 105-125 | 1/15 |
| A9A (NE-3E) | 100 | 1000 | \$5,000 | 100K | 3/8(a) | 2" wire term. | T-9(a) | 0.7 | 105-125 | 1/15 |
| B1A (NE-51) | 10 | 100 | over 15,000 | 220K | 1 1/2 | Min. Bay. | T-3 1/2 | 0.3 | 105-125 | 1/25 |
| B5A (NE-17) | 10 | 100 | 7,500 | 30K(l) | 1 1/2 | D.C. Bay. | T-4 1/2 | 2.0 | 105-125 | 1/4 |
| B7A (NE-45) | 10 | 100 | 7,500 | None | 1 1/2 | Cond. Screw | T-4 1/2 | 2.0 | 105-125 | 1/4 |
| B9A (NE-48) | 10 | 100 | 7,500 | 30K(l) | 1 1/2 | D.C. Bay. | T-4 1/2 | 2.0 | 105-125 | 1/4 |
| C1A (NE-2D) | 10 | 100 | \$5,000 | 100K | 1 1/2 | S.C. Mid. Flange | T-9(a) | 0.7 | 105-125 | 1/15 |
| F3A (NE-5T) | 10 | 100 | 7,500 | None | 1 1/2 | Cond. Screw | T-4 1/2 | 2.0 | 105-125 | 1/4 |
| F4A (NE-58) | 10 | 100 | 7,500 | None | 1 1/2 | Cond. Screw | T-4 1/2 | 2.0 | 210-250 | 1/2 |
| J5A (NE-30) | 10 | 100 | 10,000 | None | 3/4 | Med. Screw(b) | S-11 | 12.0 | 105-125 | 1 |
| J9A (NE-56) | 10 | 100 | 10,000 | None | 3/4 | Med. Screw(b) | S-11 | 3.0 | 210-250 | 1 |
| K2A (NE-3M) | 10 | 100 | \$5,000(h) | 150K | 3/8(a) | 1" wire term. | T-8(c) | 1.5 | 105-125 | 1/17 |
| R1A (NE-79) | 10 | 100 | 10,000 | 7.5K | 2 | D.C. Bay. | S-7 | 19.0 | 105-125 | 1 |
| R2A (NE-34) | 10 | 100 | 10,000 | None | 3 1/2 | Med. Screw | S-14 | 18.0 | 105-125 | 2 |

DARK EFFECT

When glow lamps are placed in a darkened environment, their starting voltage sometimes rises. Several types utilizing a radio-

active additive to reduce this effect are currently available. See footnote (h) in Average Useful Life column in above table.

FOOTNOTES

† Bulbs are designated by a letter to indicate shape and a figure to indicate the approximate diameter in eighths of an inch.

- This dimension is for glass parts only.
- Center electrode connected to base shell.
- Round end bulb.
- Life shown is for AC operation. For standard brightness lamps, life on DC will be approx. 60% of these values when DC current is equal to the R.M.S. AC value. However, when equal DC and R.M.S. AC voltages and equal resistances are utilized life will be approximately the same.

For high brightness lamps, where a minimum of 150 volts is recommended for DC operation, life with equal DC and R.M.S. AC currents will be somewhat lower than the 60% figure quoted above, and current and wattage will increase over the AC values shown in the table

- On 110-125 Volt Circuits.
- Use 150 volts minimum for satisfactory direct current operation.
- Formed tip bulb.
- Dark effect reduced.
- Three character symbol is the new trade number for this lamp recorded with the American Standards Association. The old NE number is in parentheses.
- Closest standard BA resistor value is 33K, which will provide greater than average life, at a slight decrease in current and light output.
- Flat end bulb.

‡ In order to properly control the lamp current, a ballast resistor must be used. Lamps having screw bases have the necessary resistor built-in. Those having bayonet bases and those listed with wire terminals do not have a built-in resistor. The tables show the value of the external resistor to be used for normal operation at indicated circuit volts.

AMBIENT TEMPERATURE

Use of indicator lamps in ambients exceeding 300°F, and of circuit component types in ambients exceeding -60°F to +165°F is not recommended. Resistor-attached indicator lamps are not recommended for use in ambients above 200°F because of possible resistor deterioration.

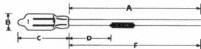
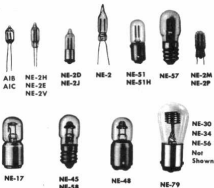

For those indicator applications where resistor attached lamps are desirable, General Electric has an extensive product line from which you may choose. NE-2E, NE-2H, NE-2M or NE-2P lamps are already available with a variety of lead lengths or resistor values, or custom types can be designed to fit your particular application. The letters on the dimensions in the above sketch are part of the standard nomenclature for attached resistor types. Thus dimension "A" is the overall length of the unresistored lead, dimension "D" is the distance between lamp seal and resistor, etc.



MINIATURE LAMP DEPARTMENT

GENERAL  **ELECTRIC**

NELA PARK, CLEVELAND OHIO 44112

3-2358-RR